



CATÁLOGO DE PRODUCTOS
2019/20



BRUEN

02	PARAFUSO AUTO-FIX CABEÇA CHATA SIMPLES	14	PARAFUSO SEXTAVADO MÉTRICO
03	PARAFUSO AUTO-FIX CABEÇA CHATA PHILIPS	15	PORCA SEXTAVADA POLEGADA & MÉTRICA
04	PARAFUSO AUTO-FIX CABEÇA PANELA SIMPLES	15	PORCA BORBOLETA LEVE & PESADA
05	PARAFUSO AUTO-FIX CABEÇA PANELA PHILIPS	16	PORCA TRAVANTE POLEGADA ALTA & BAIXA
06	PARAFUSO AUTO-FIX CABEÇA FLANGEADA PHILIPS	16	PORCA TRAVANTE MÉTRICA ALTA & BAIXA
06	PARAFUSO AUTO-FIX PANELA SIMPLES PONTA PILOTO	17	PORCA GARRA
06	PARAFUSO AUTO-FIX PANELA PHILIPS PONTA PILOTO	17	PORCA SEXTAVADA FLANGEADA SERRILHADA
08	PARAFUSO MAQ-FIX CABEÇA CHATA SIMPLES	18	ARRUELA LISA LEVE POLEGADA & MÉTRICA
09	PARAFUSO MAQ-FIX CABEÇA REDONDA SIMPLES	18	ARRUELA DE PRESSÃO POLEGADA & MÉTRICA
10	PARAFUSO MAQ-FIX CABEÇA CHATA PHILLIPS	19	ARRUELA FUNILEIRO
11	PARAFUSO MAQ-FIX CABEÇA PANELA PHILLIPS	19	BARRA ROSCADA POLEGADA & MÉTRICA
12	PARAFUSO MAQ-FIX CABEÇA LENTILHA SIMPLES	20	PARAFUSO PLAST-FIX CABEÇA FLANGEADA PHILLIPS
12	PARAFUSO MAQ-FIX CABEÇA LENTILHA PHILLIPS	21	PARAFUSO PLAST-FIX CABEÇA PANELA PHILLIPS
12	PARAFUSO MAQ-FIX CABEÇA LENTILHA TRAVA	22	PARAFUSO CHIP-FIX CABEÇA CHATA PHILLIPS
13	PARAFUSO SEXTAVADO POLEGADA	24	PARAFUSO CHIP-FIX CABEÇA PANELA PHILLIPS

SUMÁRIO

26	PARAFUSO CHIP-FIX CABEÇA FLANGEADA PHILLIPS	36	CHUMBADOR PRISIONEIRO
27	PARAFUSO MADE-FIX CABEÇA CHATA SIMPLES	37	CHUMBADOR COM PARABOLT
28	PARAFUSO MADE-FIX CABEÇA CHATA PHILLIPS	37	Jaqueta & Cone
29	PARAFUSO MADE-FIX CABEÇA TAMPINHA PHILLIPS	38	PROLONGADOR PARA CHUMBADOR
30	PARAFUSO MÁQUINA LENTILHA COMBINADA	38	SOQUETE IMANTADO
30	PARAFUSO ESTRUTURAL ESCAREADO PHILLIPS	38	PONTEIRAS
30	PARAFUSO ESTRUTURAL ESCAREADO ALLEN	39	BUCHAS
31	PARAFUSO ESTRUTURAL TAMPINHA 13 PHILLIPS	40	PARAFUSO BROCANTE CHATA PHILLIPS
31	PARAFUSO ESTRUTURAL TAMPINHA 13 ALLEN	41	PARAFUSO BROCANTE PANELA PHILLIPS
32	PARAFUSO MAQ-FIX TAMPINHA 13 PHILLIPS	42	PARAFUSO BROCANTE FLANGEADA PHILLIPS
32	PARAFUSO MAQ-FIX TAMPINHA 13 ALLEN	42	ARRUELA NEOPRENE
34	PARAFUSO FRANCÊS COM PORCA	43	PARAFUSO BROCANTE SEXTAVADO COM & SEM ARRUELA
35	PARAFUSO SEXTAVADO ROSCA SOBERBA	44	PARAFUSO DRYWALL FLANGEADA PHILLIPS PONTA AGULHA
35	PARAFUSO TELHA COM & SEM CONJ. VEDAÇÃO	44	PARAFUSO DRYWALL TROMBETA PHILLIPS PONTA AGULHA
36	CHUMBADOR COM PARAFUSO	46	REBITE DE REPUXO ALUMÍNIO NATURAL

47	REBITE DE REPUXO ALUMÍNIO NATURAL - ECONÔMICA
48	REBITE DE REPUXO ALUMÍNIO PINTADO EPÓX- CORES
49	REBITE DE REPUXO ALUMÍNIO PRETO
50	REBITE DE REPUXO ALUMÍNIO ABA LARGA
51	REBITE DE REPUXO ALUMÍNIO ABA ESCAREADA
52	REBITE DE REPUXO ALUMÍNIO FLORADO
53	REBITE DE REPUXO AÇO CARBONO
54	REBITE DE REPUXO INOX
55	REBITE DE REPUXO ALUMÍNIO HERMÉTICO
56	REBITE DE REPUXO NEW-BOLT
56	REBITE DE REPUXO NEW-LOCK
57	REBITE SEMI TUBULAR
58	REBITE MACIÇO DE ALUMÍNIO

59	REBITE MACIÇO DE FERRO
60	REBITE ROSCA INTERNA
61	REBITADORES
62	REBITADORES
64	PREGO POLIDO COM CABEÇA
65	PREGO POLIDO SEM CABEÇA
65	PREGO POLIDO CABEÇA DUPLA
66	PREGO POLIDO ARDOX COM CABEÇA
66	PREGO POLIDO ARDOX SEM CABEÇA
67	PREGO POLIDO ANELADO
67	PREGO TELHEIRO GALVANIZADO COM VEDAÇÃO
68	PREGO COIL ELETROSOLDADO

SUMÁRIO

AUTO-FIX

UTILIZADOS NA FIXAÇÃO DE CHAPAS METÁLICAS FINAS, PAREDES DE ALVENARIA COM BUCHAS DE NYLON, MÓVEIS TUBULARES E EQUIPAMENTOS EM GERAL.



DISPONÍVEL NAS OPÇÕES



CHATA
SIMPLES



CHATA
PHILIPS



PANELA
SIMPLES



PANELA
PHILIPS



FLANGEADA
COMBINADA

PANELA SIMPLES, PHILIPS
& SEXTAVADO FLANGEADO
PONTA PILOTO

CONSULTE EM OUTROS ACABAMENTOS

BICROMATIZADO - OXIDADO - NIQUELADO - ZINCADO PRETO - POLIDO



SOB CONSULTA



PANELA
COMBINADA



REBAIXADA



LENTILHA



OVAL



TAMPINHA



SEXTAVADO
FLANGEADO

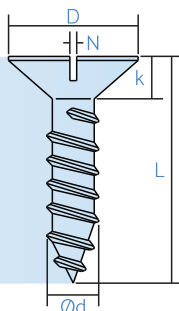

MATERIAL: AÇO BAIXO CARBONO
TRATAMENTO: CEMENTADO
ACABAMENTO: ZINCADO BRANCO
ROSCA: AUTO ATARRAXANTE TIPO C

Diâmetro	2,2	2,9	3,5	3,9	4,2	4,8	5,5	6,3
D (máx.)	4,30	5,50	6,80	7,50	8,10	9,50	10,80	12,50
k (ref.)	1,30	1,70	2,10	2,30	2,50	3,00	3,40	3,80
N (máx.)	0,90	1,00	1,30	1,30	1,40	1,60	1,80	1,90
passo	0,79	1,06	1,27	1,34	1,41	1,59	1,81	1,81
L (mm)								
6,5	R\$ 5,36 3030801 0,018 10%20	R\$ 5,16 2102501 0,027 5%20	R\$ 6,21 2103001 0,046 5%20					
9,5	R\$ 5,58 3030901 0,021 10%20	R\$ 5,55 2102601 0,039 5%20	R\$ 7,19 2103101 0,065 5%20	R\$ 8,63 2103701 0,072 5%20	R\$ 10,27 2104401 0,090 5%10	R\$ 15,23 2105401 0,125 5%10		
13	R\$ 5,86 3031001 0,028 10%20	R\$ 6,21 2102701 0,050 5%20	R\$ 8,73 2103201 0,078 5%20	R\$ 10,52 2103801 0,098 5%20	R\$ 11,71 2104601 0,114 5%10	R\$ 16,24 2105501 0,156 5%10	R\$ 19,60 2106401 0,210 5%10	R\$ 25,01 2107301 0,280 5%10
16		R\$ 6,67 2102801 0,062 5%20	R\$ 9,19 2103301 0,096 5%10	R\$ 11,53 2103901 0,116 5%10	R\$ 12,57 2104801 0,138 5%10	R\$ 17,71 2105601 0,196 5%10	R\$ 21,68 2106501 0,260 5%10	R\$ 28,37 2107401 0,330 5%10
19		R\$ 7,40 2102901 0,070 5%20	R\$ 10,87 2103401 0,108 5%10	R\$ 13,30 2104001 0,135 5%10	R\$ 14,46 2104901 0,160 5%10	R\$ 19,67 2105701 0,218 5%10	R\$ 25,01 2106601 0,294 5%10	R\$ 34,20 2107501 0,406 2%10
22			R\$ 11,95 2103501 0,120 5%10	R\$ 15,37 2104101 0,148 5%10	R\$ 15,72 2105001 0,180 5%10	R\$ 21,75 2105801 0,258 5%10	R\$ 27,49 2106701 0,316 2%10	R\$ 37,64 2107601 0,446 2%10
25			R\$ 12,92 2103601 0,134 5%10	R\$ 15,75 2104201 0,167 5%10	R\$ 17,47 2105101 0,200 5%10	R\$ 23,19 2105901 0,276 5%10	R\$ 30,98 2106801 0,362 2%10	R\$ 41,77 2107701 0,508 2%10
32				R\$ 18,41 2104301 0,215 5%10	R\$ 21,02 2105201 0,250 5%10	R\$ 27,04 2106001 0,330 5%10	R\$ 37,68 2106901 0,454 2%10	R\$ 48,51 2107801 0,630 2%10
38					R\$ 23,92 2105301 0,300 5%10	R\$ 31,64 2106101 0,395 5%8	R\$ 40,51 2107001 0,530 2%10	R\$ 55,18 2107901 0,710 2%10
45						R\$ 35,25 2106201 0,460 2%10	R\$ 47,25 2107101 0,598 2%10	R\$ 62,00 2108001 0,800 2%8
50						R\$ 39,50 2106301 0,505 2%10	R\$ 51,45 2107201 0,662 2%10	R\$ 66,12 2108101 0,920 2%8

CÓDIGOS, PREÇOS BRUTOS E PESOS POR CENTO - EMBALAGEM MÍNIMA E MASTER.



P2 90x80x50

P3 90x80x60

P4 90x80x80

P5 135x90x80

N1 135x120x90

APLICAÇÃO

Utilizados na fixação de chapas metálicas finas, paredes de alvenaria com buchas de nylon, móveis tubulares e equipamentos em geral.

MATERIAL: AÇO BAIXO CARBONO
TRATAMENTO: CEMENTADO
ACABAMENTO: ZINCADO BRANCO
ROSCA: AUTO ATARRAXANTE TIPO C

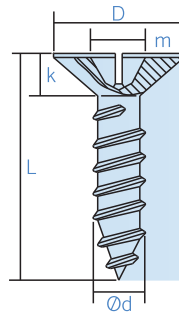

Diâmetro	2,2	2,9	3,5	3,9	4,2	4,8	5,5	6,3
D (máx.)	4,30	5,50	6,80	7,50	8,10	9,50	10,80	12,50
k (ref.)	1,30	1,70	2,10	2,30	2,50	3,00	3,40	3,80
m (ref.)	1	1	2	2	2	2	3	3
passo	0,79	1,06	1,27	1,34	1,41	1,59	1,81	1,81
L (mm)								
6,5	R\$ 5,20 3381401 0,018 10%20	R\$ 4,67 2108301 0,028 5%20	R\$ 5,93 2108801 0,048 5%20					
9,5	R\$ 5,58 2108201 0,020 10%20	R\$ 5,34 2108401 0,034 5%20	R\$ 7,47 2108901 0,061 5%20	R\$ 8,00 2109501 0,070 5%20	R\$ 10,45 2110201 0,090 5%10	R\$ 12,85 2110101 0,130 5%10		
13	R\$ 5,81 35106301 0,025 10%20	R\$ 5,93 2108501 0,050 5%20	R\$ 7,72 2109001 0,078 5%20	R\$ 9,64 2109601 0,098 5%20	R\$ 11,08 2110301 0,110 5%10	R\$ 14,98 2111101 0,150 5%10	R\$ 19,60 2112001 0,215 5%10	R\$ 24,10 2112901 0,270 5%10
16		R\$ 6,53 2108601 0,059 5%20	R\$ 9,29 2109101 0,084 5%10	R\$ 11,29 2109701 0,112 5%10	R\$ 12,64 2110401 0,140 5%10	R\$ 16,38 2112101 0,200 5%10	R\$ 22,52 2112101 0,238 5%10	R\$ 37,68 2113001 0,320 5%10
19		R\$ 7,02 2108701 0,068 5%20	R\$ 10,13 2109201 0,107 5%10	R\$ 12,57 2109801 0,128 5%10	R\$ 14,63 2110501 0,155 5%10	R\$ 19,50 2111301 0,219 5%10	R\$ 23,78 2112201 0,274 5%10	R\$ 37,92 2113101 0,416 2%20
22			R\$ 11,46 2109301 0,120 5%10	R\$ 14,07 2109901 0,152 5%10	R\$ 15,75 2110601 0,184 5%10	R\$ 20,84 2111401 0,250 5%10	R\$ 26,69 2112301 0,330 2%10	R\$ 41,18 2113201 0,460 2%10
25			R\$ 12,46 2109401 0,136 5%10	R\$ 15,47 2110101 0,174 5%10	R\$ 16,91 2110701 0,200 5%10	R\$ 22,59 2111501 0,272 5%10	R\$ 29,72 2112401 0,350 2%10	R\$ 44,85 2113301 0,490 2%10
32				R\$ 18,24 2110101 0,215 5%10	R\$ 19,74 2110801 0,251 5%10	R\$ 27,42 2111601 0,340 5%10	R\$ 35,04 2112501 0,456 2%10	R\$ 51,49 2113401 0,610 2%10
38					R\$ 23,26 2110901 0,290 5%10	R\$ 30,70 2111701 0,396 5%8	R\$ 40,27 2112601 0,504 2%10	R\$ 58,29 2113501 0,670 2%10
45						R\$ 35,56 2111801 0,460 2%10	R\$ 45,38 2112701 0,586 2%10	R\$ 65,10 2113601 0,812 2%8
50					R\$ 30,47 3287001 0,370 2%10	R\$ 38,24 2111901 0,504 2%10	R\$ 49,53 2112801 0,642 2%10	R\$ 68,22 2113701 0,900 2%8

CÓDIGOS, PREÇOS BRUTOS E PESOS POR CENTO - EMBALAGEM MÍNIMA E MASTER.



P2 90x80x50

P3 90x80x60

P4 90x80x80

P5 135x90x80

N1 135x120x90

Consulte lote mínimo

APLICAÇÃO

Utilizados na fixação de chapas metálicas finas, paredes de alvenaria com buchas de nylon, móveis tubulares e equipamentos em geral.

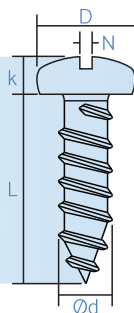

MATERIAL: AÇO BAIXO CARBONO
TRATAMENTO: CEMENTADO
ACABAMENTO: ZINCADO BRANCO
ROSCA: AUTO ATARRAXANTE TIPO C

Diâmetro	2,2	2,9	3,5	3,9	4,2	4,8	5,5	6,3
D (máx.)	4,20	5,60	6,90	7,50	8,20	9,50	10,80	12,50
k (máx.)	1,35	1,75	2,10	2,25	2,45	2,80	3,20	3,65
N (máx.)	0,90	1,00	1,30	1,30	1,40	1,60	1,80	1,90
passo	0,79	1,06	1,27	1,34	1,41	1,59	1,81	1,81
L (mm)								
6,5	R\$ 6,16 2253401 0,018 10%20	R\$ 5,44 2116501 0,036 5%20	R\$ 7,40 2117101 0,064 5%20	R\$ 11,64 2117801 0,095 5%20				
9,5	R\$ 6,60 3381501 0,022 10%20	R\$ 5,86 2116601 0,051 5%20	R\$ 8,38 2117201 0,080 5%20	R\$ 10,59 2117901 0,100 5%20	R\$ 11,71 2118601 0,126 5%10	R\$ 16,84 2119501 0,192 5%10		
13	R\$ 6,90 36006301 0,034 10%20	R\$ 6,70 2116701 0,066 5%20	R\$ 9,96 2117301 0,102 5%20	R\$ 12,32 2118001 0,112 5%20	R\$ 13,83 2118701 0,142 5%10	R\$ 18,41 2119601 0,208 5%10	R\$ 24,94 2120501 0,286 5%10	R\$ 35,56 2121401 0,430 5%10
16		R\$ 7,19 2116801 0,070 5%20	R\$ 11,29 2117401 0,112 5%10	R\$ 13,83 2118101 0,138 5%10	R\$ 14,84 2118801 0,166 5%10	R\$ 20,74 2119701 0,236 5%10	R\$ 27,63 2120601 0,318 5%10	R\$ 37,57 2121501 0,496 5%10
19		R\$ 7,96 2116901 0,075 5%20	R\$ 12,22 2117501 0,135 5%10	R\$ 15,23 2118201 0,158 5%10	R\$ 16,91 2118901 0,191 5%10	R\$ 23,12 2119801 0,272 5%10	R\$ 30,28 2120701 0,354 5%10	R\$ 41,35 2121601 0,510 2%10
22		R\$ 9,24 2117001 0,110 5%20	R\$ 13,58 2117601 0,150 5%10	R\$ 16,24 2118301 0,186 5%10	R\$ 17,99 2119001 0,213 5%10	R\$ 24,83 2119901 0,286 5%10	R\$ 31,43 2120801 0,379 2%10	R\$ 46,10 2121701 0,570 2%10
25			R\$ 14,81 2117701 0,162 5%10	R\$ 17,64 2118401 0,196 5%10	R\$ 20,53 2119101 0,228 5%10	R\$ 26,20 2120001 0,310 5%10	R\$ 33,25 2120901 0,435 2%10	R\$ 47,85 2121801 0,640 2%10
32				R\$ 20,27 2118501 0,240 5%10	R\$ 24,03 2119201 0,278 5%10	R\$ 31,05 2120101 0,390 5%10	R\$ 40,83 2121001 0,516 2%10	R\$ 54,83 2121901 0,720 2%10
38					R\$ 26,62 2119301 0,320 5%10	R\$ 35,39 2120201 0,449 5%8	R\$ 45,31 2121101 0,575 2%10	R\$ 62,09 2122001 0,840 2%10
45					R\$ 31,41 2119401 0,440 5%10	R\$ 40,62 2120301 0,501 2%10	R\$ 51,17 2121201 0,668 2%10	R\$ 68,18 2122101 0,936 2%8
50						R\$ 43,77 2120401 0,545 2%10	R\$ 55,39 2121301 0,722 2%10	R\$ 71,98 2122201 1,040 2%8

CÓDIGOS, PREÇOS BRUTOS E PESOS POR CENTO - EMBALAGEM MÍNIMA E MASTER.



P2 90x80x50

P3 90x80x60

P4 90x80x80

P5 135x90x80

N1 135x120x90

Consulte lote mínimo

APLICAÇÃO

Utilizados na fixação de chapas metálicas finas, paredes de alvenaria com buchas de nylon, móveis tubulares e equipamentos em geral.

MATERIAL: AÇO BAIXO CARBONO
TRATAMENTO: CEMENTADO
ACABAMENTO: ZINCADO BRANCO
ROSCA: AUTO ATARRAXANTE TIPO C

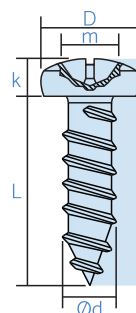

Diâmetro	2,2	2,9	3,5	3,9	4,2	4,8	5,5	6,3
D (máx.)	4,20	5,60	6,90	7,50	8,20	9,50	10,80	12,50
k (máx.)	1,80	2,20	2,60	2,80	3,05	3,55	3,95	4,55
m (ref.)	1	1	2	2	2	2	3	3
passo	0,79	1,06	1,27	1,34	1,41	1,59	1,81	1,81
L (mm)								
6,5	R\$ 4,97 <small>35005601 0,024 10%20</small>	R\$ 5,55 <small>2123001 0,041 5%20</small>	R\$ 7,47 <small>2123501 0,076 5%20</small>					
9,5	R\$ 5,20 <small>3381601 0,030 10%20</small>	R\$ 6,11 <small>2123101 0,055 5%20</small>	R\$ 8,14 <small>2123601 0,086 5%20</small>	R\$ 10,59 <small>2124201 0,102 5%20</small>	R\$ 12,71 <small>2124901 0,130 5%10</small>	R\$ 17,71 <small>2125701 0,192 5%10</small>		
13	R\$ 7,18 <small>2122901 0,038 5%20</small>	R\$ 6,67 <small>2123201 0,069 5%20</small>	R\$ 10,13 <small>2123701 0,102 5%20</small>	R\$ 12,39 <small>2124301 0,126 5%20</small>	R\$ 14,25 <small>2125001 0,156 5%10</small>	R\$ 19,50 <small>2125801 0,215 5%10</small>	R\$ 25,08 <small>2126701 0,291 5%10</small>	R\$ 34,55 <small>2127601 0,430 5%10</small>
16		R\$ 7,54 <small>2123301 0,077 5%20</small>	R\$ 11,53 <small>2123801 0,116 5%10</small>	R\$ 13,48 <small>2124401 0,150 5%10</small>	R\$ 15,58 <small>2125101 0,170 5%10</small>	R\$ 23,92 <small>2125901 0,250 5%10</small>	R\$ 28,77 <small>2126801 0,356 5%10</small>	R\$ 38,97 <small>2127701 0,460 5%10</small>
19		R\$ 8,45 <small>2123401 0,083 5%20</small>	R\$ 12,39 <small>2123901 0,135 5%10</small>	R\$ 14,98 <small>2124501 0,170 5%10</small>	R\$ 16,73 <small>2125201 0,200 5%10</small>	R\$ 24,52 <small>2126001 0,286 5%10</small>	R\$ 30,98 <small>2126901 0,375 5%10</small>	R\$ 39,18 <small>2127801 0,500 2%10</small>
22			R\$ 13,76 <small>2124001 0,150 5%10</small>	R\$ 16,42 <small>2124601 0,186 5%10</small>	R\$ 18,48 <small>2125301 0,220 5%10</small>	R\$ 25,01 <small>2126101 0,298 5%10</small>	R\$ 31,29 <small>2127001 0,390 2%10</small>	R\$ 43,94 <small>2127901 0,540 2%10</small>
25			R\$ 14,91 <small>2124101 0,165 5%10</small>	R\$ 17,64 <small>2124701 0,200 5%10</small>	R\$ 19,81 <small>2125401 0,240 5%10</small>	R\$ 26,79 <small>2126201 0,330 5%10</small>	R\$ 35,39 <small>2127101 0,444 2%10</small>	R\$ 47,36 <small>2128001 0,640 2%10</small>
32				R\$ 20,60 <small>2124801 0,250 5%10</small>	R\$ 22,91 <small>2125501 0,280 5%10</small>	R\$ 30,73 <small>2126301 0,392 5%10</small>	R\$ 40,90 <small>2127201 0,518 2%10</small>	R\$ 54,62 <small>2128101 0,740 2%10</small>
38					R\$ 26,76 <small>2125601 0,320 5%10</small>	R\$ 34,62 <small>2126401 0,454 5%8</small>	R\$ 46,45 <small>2127301 0,592 2%10</small>	R\$ 60,53 <small>2128201 0,830 2%10</small>
45						R\$ 39,92 <small>2126501 0,515 2%10</small>	R\$ 51,77 <small>2127401 0,688 2%10</small>	R\$ 68,29 <small>2128301 0,970 2%8</small>
50						R\$ 43,42 <small>2126601 0,580 2%10</small>	R\$ 55,32 <small>2127501 0,738 2%10</small>	R\$ 71,91 <small>2128401 1,030 2%8</small>

CÓDIGOS, PREÇOS BRUTOS E PESOS POR CENTO - EMBALAGEM MÍNIMA E MASTER.



P2 90x80x50

P3 90x80x60

P4 90x80x80

P5 135x90x80

N1 135x120x90

APLICAÇÃO

Utilizados na fixação de chapas metálicas finas, paredes de alvenaria com buchas de nylon, móveis tubulares e equipamentos em geral.

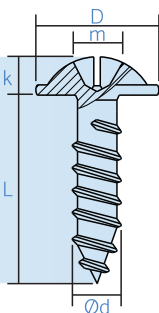

MATERIAL: AÇO BAIXO CARBONO
TRATAMENTO: CEMENTADO
ACABAMENTO: ZINCADO BRANCO
ROSCA: AUTO ATARRAXANTE TIPO C

Diâmetro	3,9	4,2	4,8			
D (máx.)	9,50	10,80	12,00			
k (máx.)	2,00	2,30	2,70			
m (ref.)	2	2	2			
passo	1,34	1,41	1,59			
L (mm)						
9,5		R\$ 15,24	2775401 0,220 5%10			
32	R\$ 24,71	2771501 0,256 5%10	R\$ 27,49	3288001 0,300 5%10	R\$ 36,87	3288101 0,256 5%8
38		R\$ 32,10	2771601 0,349 5%8	R\$ 41,55	2771701 0,460 5%8	

PARAFUSO AUTO-FIX PANELA FENDA SIMPLES & PHILIPS PONTA PILOTO
 DIN 7971 & DIN 7981

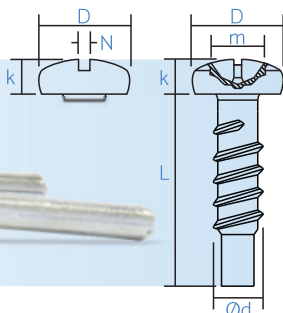

MATERIAL: AÇO BAIXO CARBONO
TRATAMENTO: CEMENTADO
ACABAMENTO: ZINCADO BRANCO
ROSCA: AUTO ATARRAXANTE TIPO C

FENDA SIMPLES - DIN 7971

FENDA PHILIPS - DIN 7981

Diâmetro	3,9	4,2	4,8			
D (máx.)	7,50	8,20	9,50			
k (máx.)	2,25	2,45	2,80			
N (máx.)	1,30	1,40	1,60			
passo	1,34	1,41	1,59			
L (mm)						
25	R\$ 20,28	2128901 0,205 5%10	R\$ 23,61	2775901 0,221 5%10	R\$ 30,61	2776201 0,319 5%10
32	R\$ 23,31	2129001 0,239 5%10	R\$ 27,63	2776001 0,281 5%10	R\$ 35,70	2129201 0,378 5%10
38		R\$ 30,14	2776101 0,314 5%10	R\$ 40,69	2129301 0,439 5%8	
45			R\$ 46,71	2750901 0,500 2%10		
50			R\$ 50,33	2129401 0,520 2%10		

Diâmetro	3,9	4,2	4,8			
D (máx.)	7,50	8,20	9,50			
k (máx.)	2,80	3,05	3,55			
m (ref.)	2	2	2			
passo	1,34	1,41	1,59			
L (mm)						
25	R\$ 20,28	2775801 0,206 5%10	R\$ 22,79	2129701 0,244 5%10	R\$ 30,82	2129801 0,320 5%10
32	R\$ 23,70	2129501 0,247 5%10	R\$ 26,34	2129601 0,293 5%10	R\$ 35,33	2128501 0,388 5%10
38		R\$ 30,77	2254801 0,322 5%10	R\$ 39,81	2128601 0,453 5%8	
50			R\$ 49,93	2128701 0,524 2%10		

CÓDIGOS, PREÇOS BRUTOS E PESOS POR CENTO - EMBALAGEM MÍNIMA E MASTER.



P2 90x80x50

P3 90x80x60

P4 90x80x80

P5 135x90x80

N1 135x120x90

Consulte lote mínimo

APLICAÇÃO



Utilizados na montagem de esquadrias de alumínio.

MAQ-FIX

SEM APLICAÇÃO ESPECÍFICA, ATENDE A VÁRIOS SEGMENTOS DE MERCADO. PODENDO SER FIXADO DIRETAMENTE NA PEÇA PRÉ ROSCADA OU ATRAVÉS DA UTILIZAÇÃO DE PORCAS.



OUTROS ACABAMENTOS

BICROMATIZADO - OXIDADO - NIQUELADO - ZINCADO PRETO - POLIDO

DISPONÍVEL NAS OPÇÕES



CHATA
SIMPLES



REDONDA
SIMPLES



TAMPINHA
PHILIPS



LENTILHA
SIMPLES



LENTILHA
PHILIPS



LENTILHA
COM TRAVA



CHATA
PHILIPS



PANELA
PHILIPS



SEXTAVADO

BARRAS, PORCAS & ARRUELAS



PARAFUSO PARA CABO DE PANELA

MATERIAL: AÇO BAIXO CARBONO
ACABAMENTO: ZINCADO BRANCO
ROSCA: MÁQUINA UNC/BSW

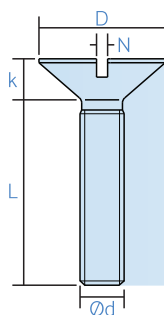

Diâmetro	1/8"	5/32"	3/16"	1/4"	5/16"	3/8"
D (máx.)	5,50	7,00	9,00	11,00	14,00	16,00
k (máx.)	1,50	1,90	2,30	2,80	3,40	3,70
N (máx.)	1,00	1,30	1,50	1,90	2,10	2,30
passo	0,64	0,79	1,06	1,27	1,41	1,59
L (")						
1/4"	R\$ 5,44 2780301 0,037 5%20	R\$ 6,16 2781501 0,064 5%20				
5/16"	R\$ 5,63 2780401 0,044 5%20	R\$ 6,99 2781701 0,068 5%20				
3/8"	R\$ 6,16 2780501 0,053 5%20	R\$ 8,24 2781801 0,089 5%20	R\$ 11,05 2783201 0,126 5%10	R\$ 20,54 2784901 0,240 5%10		
1/2"	R\$ 7,52 2780401 0,069 5%10	R\$ 9,34 2781901 0,109 5%10	R\$ 13,60 2783301 0,156 5%10	R\$ 23,40 2785001 0,310 5%10	R\$ 38,80 2786301 0,524 2%10	
5/8"	R\$ 7,86 2780701 0,081 5%10	R\$ 11,05 2782001 0,128 5%10	R\$ 14,78 2783401 0,184 5%10	R\$ 25,45 2785101 0,369 2%10	R\$ 40,05 2786401 0,575 2%10	
3/4"	R\$ 8,70 2780801 0,094 5%10	R\$ 12,45 2782101 0,143 5%10	R\$ 17,36 2783501 0,220 5%10	R\$ 29,73 2785201 0,422 2%10	R\$ 48,26 2786501 0,701 2%10	R\$ 70,45 2787501 1,044 1%10
7/8"	R\$ 10,02 2780901 0,106 5%10	R\$ 14,06 2782201 0,171 5%10	R\$ 19,10 2783601 0,252 5%10	R\$ 32,17 2785301 0,469 2%10	R\$ 53,66 2786601 0,802 2%10	R\$ 78,31 2787601 1,180 1%10
1"	R\$ 10,16 2781001 0,123 5%10	R\$ 15,20 2782301 0,188 5%10	R\$ 20,92 2783801 0,284 5%10	R\$ 36,72 2785401 0,544 2%10	R\$ 60,80 2786701 0,940 2%10	R\$ 86,36 2787701 1,318 1%10
1.1/4"	R\$ 13,30 2781101 0,144 2%10	R\$ 20,12 2782401 0,238 2%10	R\$ 25,29 2783901 0,360 2%10	R\$ 42,20 2785501 0,628 2%8	R\$ 68,21 2786801 1,072 2%10	R\$ 102,22 2787801 1,592 1%10
1.1/2"	R\$ 15,61 2781201 0,179 2%10	R\$ 20,58 2782501 0,272 2%10	R\$ 28,71 2784001 0,408 2%10	R\$ 48,75 2785601 0,748 2%10	R\$ 80,47 2786901 1,275 2%8	R\$ 117,99 2787901 1,866 1%8
1.3/4"	R\$ 17,01 2781301 0,211 2%10	R\$ 24,65 2782601 0,316 2%10	R\$ 32,70 2784101 0,478 2%10	R\$ 55,59 2785701 0,864 2%10	R\$ 90,00 2787001 1,440 2%10	R\$ 133,98 2788001 2,141 1%8
2"	R\$ 18,76 2781401 0,226 2%10	R\$ 28,55 2782701 0,376 2%10	R\$ 35,96 2784201 0,526 2%10	R\$ 62,24 2785801 1,004 2%8	R\$ 102,98 2787101 1,651 1%10	R\$ 149,85 2788101 2,434 1%8
2.1/4"		R\$ 31,34 2782801 0,431 2%10	R\$ 41,36 2784301 0,625 2%10	R\$ 70,83 2798201 1,079 2%8	R\$ 119,92 2788801 1,846 1%10	R\$ 165,60 2788201 2,689 1%8
2.1/2"		R\$ 32,97 2782901 0,470 2%10	R\$ 44,66 2784401 0,650 2%10	R\$ 75,56 2785901 1,195 1%10	R\$ 125,05 2787201 2,050 1%8	R\$ 181,33 2788301 2,963 1%8
2.3/4"			R\$ 52,71 2784501 0,754 2%8	R\$ 86,36 2786001 1,343 1%8	R\$ 138,32 2788901 2,192 1%8	R\$ 197,32 2788401 3,238 1%8
3"			R\$ 53,17 2784601 0,800 2%8	R\$ 89,01 2786101 1,439 1%8	R\$ 145,74 2787301 2,369 1%8	R\$ 213,12 2788501 3,512 0,5%8
3.1/2"			R\$ 63,80 2784701 0,942 1%10	R\$ 96,50 2786201 1,655 1%8	R\$ 160,07 2787401 2,740 1%8	R\$ 234,99 2788601 4,024 0,5%8
4"			R\$ 67,41 2784801 1,049 1%8	R\$ 108,42 2734701 1,900 1%8	R\$ 178,03 2789001 3,216 1%8	R\$ 256,76 2788701 4,536 0,5%8

CÓDIGOS, PREÇOS BRUTOS E PESOS POR CENTO - EMBALAGEM MÍNIMA E MASTER.



P2 90x80x50

P3 90x80x60

P4 90x80x80

P5 135x90x80

N1 135x120x90

APLICAÇÃO



Sem aplicação específica, atende vários segmentos de mercado. Podendo ser fixado diretamente na peça pré roscada ou através da utilização de porcas.





MATERIAL: AÇO BAIXO CARBONO
 ACABAMENTO: ZINCADO BRANCO
 ROSCA: MÁQUINA UNC/BSW

Diâmetro	1/8"	5/32"	3/16"	1/4"	5/16"	3/8"
D (máx.)	6,00	7,80	9,10	12,00	15,00	18,00
k (máx.)	2,40	3,00	3,50	4,40	5,50	6,50
N (máx.)	1,10	1,30	1,50	1,90	2,10	2,30
passo	0,63	0,79	1,06	1,27	1,41	1,59
L (")						
1/4"	R\$ 6,08 <small>2789101 0,056 5%20</small>	R\$ 8,17 <small>2790401 0,090 5%20</small>				
5/16"	R\$ 6,35 <small>2789201 0,060 5%20</small>	R\$ 9,04 <small>2790501 0,102 5%20</small>	R\$ 13,49 <small>2792101 0,169 5%20</small>			
3/8"	R\$ 6,92 <small>2789301 0,069 5%20</small>	R\$ 9,68 <small>2790601 0,111 5%20</small>	R\$ 14,32 <small>2792201 0,183 5%10</small>	R\$ 26,47 <small>2793701 0,383 5%10</small>		
1/2"	R\$ 8,05 <small>2789401 0,080 5%10</small>	R\$ 11,43 <small>2790701 0,137 5%10</small>	R\$ 16,48 <small>2792401 0,218 5%10</small>	R\$ 30,22 <small>2793901 0,434 5%10</small>	R\$ 50,67 <small>2795201 0,767 2%10</small>	
5/8"	R\$ 9,08 <small>2789501 0,096 5%10</small>	R\$ 12,37 <small>2790801 0,155 5%10</small>	R\$ 18,57 <small>2792501 0,248 5%10</small>	R\$ 34,14 <small>2794001 0,504 2%10</small>	R\$ 55,48 <small>2795301 0,860 2%10</small>	
3/4"	R\$ 10,06 <small>2789601 0,110 5%10</small>	R\$ 13,76 <small>2790901 0,174 5%10</small>	R\$ 20,35 <small>2792601 0,290 5%10</small>	R\$ 35,81 <small>2794101 0,542 2%10</small>	R\$ 59,59 <small>2795401 0,951 2%10</small>	R\$ 92,24 <small>2796601 1,480 1%10</small>
7/8"	R\$ 11,16 <small>2789701 0,127 5%10</small>	R\$ 14,89 <small>2791001 0,203 5%10</small>	R\$ 22,02 <small>2792701 0,310 5%10</small>	R\$ 40,02 <small>2794201 0,610 2%10</small>	R\$ 64,36 <small>2795501 1,035 2%10</small>	R\$ 100,14 <small>2796701 1,584 1%10</small>
1"	R\$ 12,18 <small>2789801 0,140 5%10</small>	R\$ 17,01 <small>2791101 0,218 5%10</small>	R\$ 24,12 <small>2792801 0,342 5%10</small>	R\$ 43,22 <small>2794301 0,660 2%10</small>	R\$ 69,12 <small>2795601 1,117 2%10</small>	R\$ 108,30 <small>2796801 1,740 1%10</small>
1.1/4"	R\$ 14,32 <small>2789901 0,165 2%10</small>	R\$ 20,92 <small>2791201 0,260 2%10</small>	R\$ 27,53 <small>2792901 0,409 2%10</small>	R\$ 48,79 <small>2794401 0,773 2%10</small>	R\$ 81,61 <small>2795701 1,321 2%10</small>	R\$ 123,99 <small>2796901 1,990 1%8</small>
1.1/2"	R\$ 16,14 <small>2790101 0,191 2%10</small>	R\$ 21,83 <small>2791301 0,308 2%10</small>	R\$ 32,06 <small>2793001 0,475 2%10</small>	R\$ 55,71 <small>2794501 0,890 2%10</small>	R\$ 91,52 <small>2795801 1,491 2%4</small>	R\$ 139,87 <small>2797001 2,300 1%8</small>
1.3/4"	R\$ 20,08 <small>2790201 0,246 2%10</small>	R\$ 26,24 <small>2791401 0,347 2%10</small>	R\$ 35,39 <small>2793101 0,531 2%10</small>	R\$ 62,51 <small>2794601 1,020 2%10</small>	R\$ 102,71 <small>2795901 1,687 2%8</small>	R\$ 153,72 <small>2797101 2,628 1%8</small>
2"	R\$ 20,39 <small>2790301 0,255 2%10</small>	R\$ 29,86 <small>2791501 0,396 2%10</small>	R\$ 39,56 <small>2793201 0,598 2%10</small>	R\$ 72,68 <small>2794701 1,120 2%8</small>	R\$ 114,50 <small>2796001 1,869 1%10</small>	R\$ 171,68 <small>2797201 2,790 1%8</small>
2.1/4"		R\$ 32,85 <small>2791601 0,461 2%10</small>	R\$ 43,60 <small>2793801 0,654 2%10</small>	R\$ 78,88 <small>2798401 1,250 2%8</small>	R\$ 132,20 <small>2798501 2,074 1%10</small>	R\$ 187,29 <small>2797301 3,176 1%8</small>
2.1/2"		R\$ 34,67 <small>2791701 0,490 2%10</small>	R\$ 48,79 <small>2793301 0,730 2%10</small>	R\$ 82,93 <small>2794801 1,350 1%10</small>	R\$ 135,15 <small>2796101 2,232 1%8</small>	R\$ 203,21 <small>2797401 3,367 1%8</small>
2.3/4"			R\$ 52,67 <small>2793401 0,775 2%8</small>	R\$ 90,04 <small>2798701 1,483 1%10</small>	R\$ 147,15 <small>2796201 2,508 1%8</small>	R\$ 219,03 <small>2797501 3,664 1%8</small>
3"		R\$ 41,61 <small>2791801 0,594 2%8</small>	R\$ 56,05 <small>2793501 0,856 2%8</small>	R\$ 96,54 <small>2794901 1,550 1%8</small>	R\$ 159,31 <small>2796301 2,657 1%8</small>	R\$ 235,06 <small>2797601 4,514 0,5%8</small>
3.1/2"			R\$ 62,85 <small>2797801 0,997 1%10</small>	R\$ 115,07 <small>2795001 1,880 1%8</small>	R\$ 181,40 <small>2796401 2,984 1%8</small>	R\$ 251,05 <small>2798001 4,514 0,5%8</small>
4"			R\$ 69,65 <small>2793601 1,112 1%8</small>	R\$ 124,18 <small>2795101 2,030 1%8</small>	R\$ 206,01 <small>2796501 3,362 0,5%8</small>	R\$ 276,88 <small>2797701 5,036 0,5%8</small>

CÓDIGOS, PREÇOS BRUTOS E PESOS POR CENTO - EMBALAGEM MÍNIMA E MASTER.

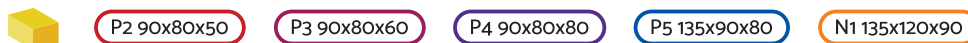

APLICAÇÃO

Sem aplicação específica, atende vários segmentos de mercado. Podendo ser fixado diretamente na peça pré roscada ou através da utilização de porcas

MATERIAL: AÇO BAIXO CARBONO
ACABAMENTO: BICROMATIZADO
ROSCA: MÁQUINA MÉTRICO

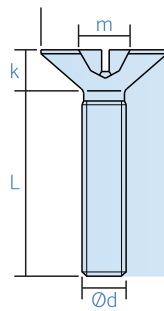

Diâmetro	M3	M4	M5	M6	M8
D (máx.)	5,60	7,50	9,20	11,00	14,50
k (máx.)	1,65	2,20	2,50	3,00	4,00
m (ref.)	1	2	2	3	4
passo	0,50	0,70	0,80	1,00	1,25
L (mm)					
6	R\$ 4,50 3348501 0,034 5%10				
8	R\$ 5,47 3348601 0,044 5%10	R\$ 8,85 3349401 0,088 5%10			
10	R\$ 6,01 3348701 0,060 5%10	R\$ 8,94 3349501 0,110 5%10	R\$ 14,27 3350401 0,160 5%10		
12	R\$ 6,47 3348801 0,068 5%10	R\$ 9,56 3349601 0,118 5%10	R\$ 14,66 3350501 0,188 5%10	R\$ 26,71 3351501 0,272 2%10	
16	R\$ 7,40 3348901 0,076 5%10	R\$ 12,16 3349701 0,146 5%10	R\$ 17,58 3350601 0,232 5%10	R\$ 30,58 3351601 0,348 2%10	R\$ 64,05 3352601 0,648 2%10
18		R\$ 13,49 3356101 0,200 5%10	R\$ 18,97 3356501 0,258 5%10	R\$ 32,41 3356701 0,376 2%10	R\$ 69,06 3357001 0,732 2%10
20	R\$ 8,50 3349001 0,094 5%10	R\$ 13,95 3349801 0,207 5%10	R\$ 20,39 3350701 0,288 2%10	R\$ 34,77 3351701 0,400 2%10	R\$ 72,11 3352701 0,790 2%10
25	R\$ 10,35 3349101 0,116 5%10	R\$ 16,41 3349901 0,214 5%10	R\$ 24,01 3350801 0,344 2%10	R\$ 39,52 3351801 0,494 2%10	R\$ 80,16 3352801 0,946 1%10
30	R\$ 11,66 3349301 0,132 5%10	R\$ 18,87 3350001 0,257 5%10	R\$ 26,27 3350901 0,402 2%10	R\$ 43,86 3351901 0,570 2%10	R\$ 86,15 3352901 1,086 1%10
35		R\$ 21,48 3350101 0,260 2%10	R\$ 30,97 3351001 0,462 2%10	R\$ 49,64 3352001 0,664 1%10	R\$ 96,11 3353001 1,250 1%10
40		R\$ 23,73 3350301 0,322 2%10	R\$ 36,84 3351101 0,518 2%10	R\$ 53,70 3352101 0,750 1%10	R\$ 102,66 3353101 1,424 1%10
45		R\$ 24,98 3356301 0,361 2%10	R\$ 40,26 3351301 0,578 2%10	R\$ 58,10 3352301 0,800 1%10	R\$ 112,80 3353301 1,562 1%10
50		R\$ 26,81 3356401 0,396 2%10	R\$ 43,47 3351401 0,636 2%10	R\$ 61,79 3352401 0,932 1%10	R\$ 124,00 3353401 1,720 1%10
60			R\$ 51,31 3356601 0,758 2%10	R\$ 73,09 3352501 1,088 1%10	R\$ 143,89 3353501 2,024 1%8
70				R\$ 83,97 3356801 1,254 1%10	R\$ 159,80 3353601 2,296 1%8
80				R\$ 95,77 3356901 1,426 1%8	R\$ 190,14 3353701 2,622 1%8

CÓDIGOS, PREÇOS BRUTOS E PESOS POR CENTO - EMBALAGEM MÍNIMA E MASTER.



P2 90x80x50

P3 90x80x60

P4 90x80x80

P5 135x90x80

N1 135x120x90

APLICAÇÃO



Sem aplicação específica, atende vários segmentos de mercado. Podendo ser fixado diretamente na peça pré roscada ou através da utilização de porcas.



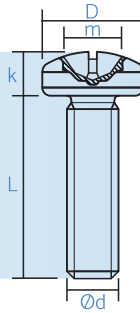

MATERIAL: AÇO BAIXO CARBONO
ACABAMENTO: BICROMATIZADO
ROSCA: MÁQUINA MÉTRICO

Diâmetro	M3		M4		M5		M6		M8	
D (máx.)	6,00		8,00		10,00		12,00		16,00	
k (máx.)	2,52		3,25		3,95		4,75		6,18	
m (ref.)	1		2		2		3		4	
passo	0,50		0,70		0,80		1,00		1,25	
L (mm)										
6	R\$ 6,38	3340501 0,060 5%10								
8	R\$ 6,92	3340601 0,070 5%10	R\$ 12,05	3341301 0,136 5%10						
10	R\$ 7,51	3340701 0,080 5%10	R\$ 12,83	3341401 0,156 5%10	R\$ 18,84	3342201 0,280 5%10				
12	R\$ 7,97	3340801 0,084 5%10	R\$ 13,85	3341501 0,170 5%10	R\$ 20,53	3342301 0,301 5%10	R\$ 32,37	3343301 0,460 2%10		
16	R\$ 8,99	3340901 0,104 5%10	R\$ 15,16	3341601 0,198 5%10	R\$ 22,86	3342401 0,348 5%10	R\$ 35,99	3343401 0,540 2%10	R\$ 74,82	3344301 1,138 2%10
18			R\$ 15,92	3359901 0,220 5%10	R\$ 24,08	3360301 0,374 5%10	R\$ 38,33	3360501 0,592 2%10	R\$ 79,20	3360801 1,202 2%10
20	R\$ 10,10	3341001 0,122 5%10	R\$ 16,62	3341701 0,234 5%10	R\$ 25,29	3342501 0,398 2%10	R\$ 40,62	3343501 0,596 2%10	R\$ 83,57	3344401 1,250 2%10
25	R\$ 11,91	3341101 0,134 5%10	R\$ 18,94	3341801 0,264 5%10	R\$ 28,87	3342601 0,456 2%10	R\$ 44,74	3343601 0,694 2%10	R\$ 93,63	3344501 1,426 1%10
30	R\$ 13,20	3341201 0,160 5%10	R\$ 20,87	3341901 0,298 5%10	R\$ 32,04	3342701 0,524 2%10	R\$ 49,06	3343701 0,780 2%10	R\$ 98,56	3344601 1,578 1%10
35			R\$ 23,56	3342001 0,336 2%10	R\$ 36,80	3342801 0,589 2%10	R\$ 54,66	3343801 0,876 1%10	R\$ 111,66	3344701 1,711 1%10
40			R\$ 26,20	3342101 0,372 2%10	R\$ 39,23	3342901 0,632 2%10	R\$ 59,23	3343901 0,944 1%10	R\$ 119,09	3344801 1,854 1%10
45			R\$ 29,12	3360001 0,435 2%10	R\$ 42,51	3343001 0,696 2%10	R\$ 63,17	3337401 1,035 1%10	R\$ 131,21	3344901 1,892 1%10
50			R\$ 32,31	3360101 0,477 2%10	R\$ 45,96	3343101 0,748 2%10	R\$ 67,49	3344001 1,124 1%10	R\$ 143,32	3345001 2,176 1%10
60					R\$ 54,25	3360401 0,874 2%8	R\$ 75,56	3344101 1,288 1%10	R\$ 161,33	3345101 2,444 1%8
70							R\$ 86,15	3360601 1,466 1%8	R\$ 176,68	3345301 2,812 1%0
80							R\$ 98,19	3360701 1,644 1%8	R\$ 207,37	3345401 3,260 1%6

CÓDIGOS, PREÇOS BRUTOS E PESOS POR CENTO - EMBALAGEM MÍNIMA E MASTER.

- P2 90x80x50
- P3 90x80x60
- P4 90x80x80
- P5 135x90x80
- N1 135x120x90
- Ps2 155x130x135

APLICAÇÃO

Sem aplicação específica, atende vários segmentos de mercado.
 Podendo ser fixado diretamente na peça pré roscada ou através da utilização de porcas.

MATERIAL: AÇO BAIXO CARBONO
ACABAMENTO: ZINCADO BRANCO
ROSCA: MÁQUINA UNC

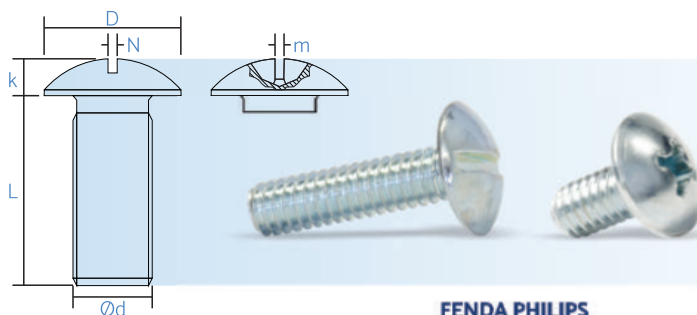

FENDA SIMPLES

Diâmetro		1/4"	
D (máx.)		14,50	
k (máx.)		3,80	
N (máx.)		1,90	
Rosca - Fio		UNC-20	
L (")			
3/8"	R\$	24,09	3000601 0,420 5%10
1/2"	R\$	26,91	3000001 0,500 5%10
5/8"	R\$	29,12	3000101 0,580 2%10
3/4"	R\$	32,61	3000201 0,630 2%10
7/8"	R\$	33,28	3000301 0,694 2%10
1"	R\$	35,71	3089201 0,738 2%10
1.1/2"	R\$	49,81	3443501 0,820 2%10
1.3/4"	R\$	52,51	3089301 1,046 2%10
2"	R\$	55,17	3089401 1,202 2%10

FENDA PHILIPS

Diâmetro		1/4"	
D (máx.)		14,50	
k (máx.)		3,80	
m (máx.)		3	
Rosca - Fio		UNC-20	
L (")			
1/2"	R\$	26,91	3039001 0,500 5%10
5/8"	R\$	28,86	3084801 0,541 2%10
3/4"	R\$	31,79	3281801 0,628 2%10
1"	R\$	35,13	3024001 0,723 2%10
1.1/4"	R\$	44,98	3024101 0,800 2%10

PARAFUSO MAQ-FIX LENTILHA COM TRAVA

MATERIAL: AÇO BAIXO CARBONO
ACABAMENTO: ZINCADO BRANCO
ROSCA: MÁQUINA UNC/BSW

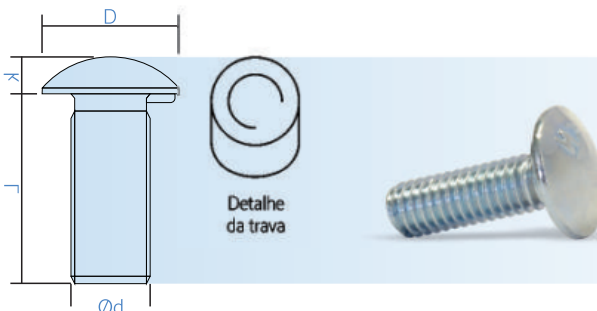

Diâmetro	1/4"		5/16"		3/8"	
D (máx.)	14,50		17,70		20,90	
k (máx.)	3,80		4,60		5,40	
Rosca - Fio	UNC-20		UNC-18		UNC-16	
L (")						
1/2"	R\$	28,09	3132901 0,570 5%10	R\$	45,76	3133301 0,946 2%10
5/8"	R\$	30,92	3133001 0,590 2%10	R\$	51,00	3133401 1,020 2%10
3/4"	R\$	34,21	3133101 0,670 2%10	R\$	55,42	3133501 1,086 2%10
1"	R\$	36,15	3133201 0,770 2%10	R\$	69,09	3133601 1,260 2%10
						R\$
						75,50
						84,33
						92,24
						97,52

CÓDIGOS, PREÇOS BRUTOS E PESOS POR CENTO - EMBALAGEM MÍNIMA E MASTER.

- P2 90x80x50
- P3 90x80x60
- P4 90x80x80
- P5 135x90x80
- N1 135x120x90

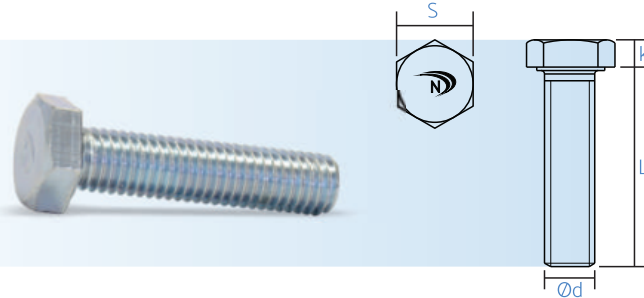

MATERIAL: AÇO BAIXO CARBONO
 ACABAMENTO: ZINCADO BRANCO
 ROSCA: MÁQUINA UNC/BSW

Diâmetro	3/16"		1/4"		5/16"		3/8"		1/2"	
S (máx.)	5/16"		7/16"		1/2"		9/16"		3/4"	
k (máx.)	3,00		4,00		5,15		5,95		7,90	
Rosca - Fio	BSW-24		UNC-20		UNC-18		UNC-16		UNC-13/BSW-12	
L (")										
1/2"	R\$ 13,32	2949501 0,240 5%10	R\$ 31,67	2952001 0,524 5%10	R\$ 53,26	2954201 0,876 5%6	R\$ 74,75	2956801 1,292 2%10		
5/8"	R\$ 14,70	2949601 0,276 5%10	R\$ 34,39	2952201 0,590 5%6	R\$ 57,27	2954401 0,966 5%6	R\$ 88,43	2957001 1,438 2%10		
3/4"	R\$ 16,81	2949701 0,294 5%10	R\$ 37,17	2952401 0,634 5%6	R\$ 62,26	2954601 1,066 2%10	R\$ 91,26	2957201 1,550 2%6	R\$ 194,29	2960601 2962601 3,284 2%4
7/8"	R\$ 17,90	2949801 0,324 5%10	R\$ 39,69	2952601 0,700 5%6	R\$ 66,01	2954801 1,170 2%10	R\$ 100,66	2957401 1,694 2%6	R\$ 203,95	2947501 2947001 3,528 1%4
1"	R\$ 19,90	2949901 0,360 5%10	R\$ 42,93	2952801 0,760 5%6	R\$ 69,97	2955001 1,248 2%10	R\$ 108,43	2957601 1,852 2%6	R\$ 219,32	2960801 2962701 3,732 1%6
1.1/4"	R\$ 23,08	2950101 0,420 5%6	R\$ 47,50	2953201 0,854 2%10	R\$ 79,59	2955201 1,438 2%6	R\$ 118,97	2957801 2,130 2%6	R\$ 242,92	2961001 2962801 4,206 1%6
1.1/2"	R\$ 26,37	2950001 0,492 5%6	R\$ 54,19	2953001 0,984 2%10	R\$ 92,59	2955401 1,614 2%6	R\$ 137,63	2958001 2,388 2%6	R\$ 266,62	2961201 2962901 4,613 1%4
1.3/4"	R\$ 29,41	2950201 0,558 2%10	R\$ 59,28	2953401 1,080 2%6	R\$ 98,76	2955601 1,808 2%6	R\$ 147,45	2958201 2,658 2%4	R\$ 292,89	2961401 2963001 5,230 1%4
2"	R\$ 32,39	2950301 0,618 2%10	R\$ 65,29	2953601 1,184 2%6	R\$ 110,28	2955801 2,002 2%4	R\$ 160,25	2958401 2,926 2%4	R\$ 315,82	2961601 2963101 5,746 1%4
2.1/4"			R\$ 72,49	2944801 1,328 2%6	R\$ 113,16	2945401 2,186 2%4	R\$ 177,06	2945801 3,224 1%6	R\$ 345,69	2947601 2947101 6,262 0,5%6
2.1/2"			R\$ 77,58	2953801 1,428 2%6	R\$ 129,97	2956001 2,360 1%6	R\$ 185,47	2958601 3,508 1%6	R\$ 376,03	2961901 2861501 6,720 0,5%6
2.3/4"			R\$ 82,72	2944901 1,544 1%6	R\$ 138,66	2945501 2,528 1%6	R\$ 193,46	2945901 3,740 1%6	R\$ 400,96	2947701 2963201 7,178 0,5%6
3"			R\$ 89,61	2954001 1,652 1%6	R\$ 147,29	2956201 2,704 1%6	R\$ 218,60	2958801 4,048 1%4	R\$ 417,36	2962101 2947201 7,332 0,5%6
3.1/2"			R\$ 101,59	2945001 1,880 1%6	R\$ 163,80	2956401 3,070 1%4	R\$ 249,14	2959001 4,687 1%4	R\$ 467,90	2962301 2963301 8,740 0,5%4
4"			R\$ 113,00	2945101 2,104 1%6	R\$ 182,46	2956601 3,428 1%4	R\$ 273,87	2959201 5,126 1%4	R\$ 514,94	2962501 2963401 9,806 0,5%4
4.1/2"			R\$ 125,50	2945201 2,328 1%4	R\$ 206,68	2945601 3,772 1%4	R\$ 319,68	2946001 5,640 0,5%4	R\$ 569,59	2947801 2947301 10,726 0,5%4
5"			R\$ 137,99	2945301 2,530 1%4	R\$ 224,16	2945701 4,146 1%4	R\$ 327,39	2946101 6,198 0,5%4	R\$ 624,24	2947901 2947401 11,680 0,5%4

CÓDIGOS, PREÇOS BRUTOS E PESOS POR CENTO - EMBALAGEM MÍNIMA E MASTER.



P4 90x80x80

P5 135x90x80

Ps2 155x130x135

Ps3 200x130x90

Ps4 230x130x90

UNC
BSW

APLICAÇÃO

Sem aplicação específica, atende vários segmentos de mercado.
 Podendo ser fixado diretamente na peça pré roscada ou através da utilização de porcas.

MATERIAL: AÇO BAIXO CARBONO
 ACABAMENTO: ZINCADO BRANCO
 ROSCA: MÁQUINA MÉTRICO

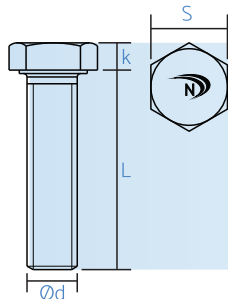

Diâmetro	M5		M6		M8		M10		M12						
S (máx.)	8,00		10,00		13,00		17,00		19,00						
k (máx.)	3,55		4,05		5,35		6,45		7,55						
passo	0,80		1,00		1,25		1,50		1,75						
L (mm)															
10	R\$ •	14,88	3192201 0,256 5%10	R\$ •	24,64	3193001 0,421 5%10									
12	R\$ •	16,42	3192301 0,279 5%10	R\$ •	26,82	3193101 0,453 5%10									
16	R\$ •	19,35	3192401 0,322 5%10	R\$ •	30,88	3193201 0,524 5%8	R\$ •	60,89	3194301 1,059 5%6	R\$ •	113,44	3195801 1,940 1%10			
18	R\$ •	20,07	3192501 0,346 5%10	R\$ •	31,14	3193301 0,542 5%10									
20	R\$ •	20,33	3192601 0,368 5%10	R\$ •	34,13	3193401 0,585 2%10	R\$ •	68,40	3194401 1,176 2%10	R\$ •	120,96	3195901 2,140 2%6	R\$ •	183,18	3197401 3,129 1%6
22				R\$ •	35,41	3193501 0,619 2%10	R\$ •	71,08	3194501 1,240 2%10	R\$ •	126,26	3196001 2,242 2%6			
25	R\$ •	23,32	3192701 0,438 5%10	R\$ •	37,93	3193601 0,665 2%10	R\$ •	76,38	3194601 1,311 2%10	R\$ •	134,90	3196101 2,381 2%6	R\$ •	201,25	3197501 3,426 1%6
30	R\$ •	26,66	3192801 0,493 5%6	R\$ •	42,51	3013401 0,753 2%10	R\$ •	80,91	3194701 1,474 2%6	R\$ •	143,76	3196201 2,430 2%4	R\$ •	219,11	3197601 3,830 1%6
35	R\$ •	29,39	3192901 0,548 5%6	R\$ •	47,04	3193701 0,844 2%10	R\$ •	91,51	3194801 1,623 2%6	R\$ •	162,96	3196301 2,955 2%4	R\$ •	236,97	3197701 4,153 1%6
40	R\$ •	33,46	3122101 0,616 5%6	R\$ •	51,26	3193801 0,879 2%6	R\$ •	101,14	3194901 1,773 2%6	R\$ •	173,46	3196401 3,097 2%4	R\$ •	252,41	3197801 4,512 1%6
45				R\$ •	55,79	3193901 1,009 2%10	R\$ •	107,11	3195001 1,950 2%6	R\$ •	186,79	3196501 3,332 2%4	R\$ •	274,49	3197901 4,898 1%6
50				R\$ •	59,86	3194001 1,090 2%6	R\$ •	115,19	3195101 2,091 2%4	R\$ •	197,13	3196601 3,601 2%4	R\$ •	292,51	3198001 5,207 1%4
55				R\$ •	64,34	3194101 1,183 2%6	R\$ •	122,65	3195201 2,270 2%4	R\$ •	214,17	3196701 3,845 1%4	R\$ •	310,16	3198101 5,616 1%4
60				R\$ •	68,20	3194201 1,253 2%6	R\$ •	131,04	3195301 2,387 2%4	R\$ •	223,18	3196801 4,306 1%4	R\$ •	326,27	3198201 5,888 0,5%6
65							R\$ •	138,35	3195401 2,516 2%4	R\$ •	236,51	3197001 4,546 1%4	R\$ •	346,45	3198301 6,328 0,5%6
70							R\$ •	141,54	3195501 2,712 1%6	R\$ •	249,58	3197101 5,080 1%4	R\$ •	366,42	3198401 6,734 0,5%6
80							R\$ •	160,54	3195601 3,056 1%4	R\$ •	275,47	3197201 5,550 1%4	R\$ •	400,75	3198501 7,345 0,5%6
90										R\$ •	300,82	3197201 5,550 1%4			
100							R\$ •	194,04	3195701 3,631 1%4	R\$ •	326,17	3197301 6,010 1%4	R\$ •	476,26	3198601 8,742 0,5%4

CÓDIGOS, PREÇOS BRUTOS E PESOS POR CENTO - EMBALAGEM MÍNIMA E MASTER.



P3 90x80x60

P4 90x80x80

P5 135x90x80

Ps2 155x130x135

Ps3 200x130x90

Ps4 230x130x90

APLICAÇÃO



Sem aplicação específica, atende vários segmentos de mercado. Podendo ser fixado diretamente na peça pré roscada ou através da utilização de porcas.



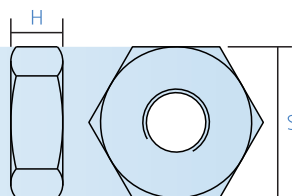

MATERIAL: AÇO BAIXO CARBONO
ACABAMENTO: ZINCADO BRANCO
ROSCA: MÁQUINA UNC/BSW

POLEGADA			S (máx.)	H (máx.)	Rosca - Fio
1/8"	R\$ 10,27	3438501 0.055 20%10	1/4"	2.90	UNC-40
5/32"	R\$ 10,37	2746601 0.049 20%10	1/4"	2.90	UNC-32
5/32"	R\$ 12,03	3330801 0.100 20%10	5/16"	3.30	UNC-32
3/16"	R\$ 12,30	2746701 0.100 20%10	5/16"	4.20	UNC-24
1/4"	R\$ 23,22	2746801 0.329 10%8	7/16"	5.74	UNC-20
5/16"	R\$ 32,48	2746901 0.472 5%10	1/2"	6.93	UNC-18
3/8"	R\$ 47,00	2747001 0.643 2%10	9/16"	8.56	UNC-16
1/2"	R\$ 110,58	2747501 1.400 1%10	3/4"	11.38	BSW-12
1/2"	R\$ 110,58	2747401 1.400 1%10	3/4"	11.38	UNC-13
5/8"	R\$ 224,62	2747101 3.175 1%8	15/16"	14.20	UNC-11
3/4"	R\$ 345,56	2747201 4.943 0.5%8	1.1/8"	16.89	UNC-10
7/8"	R\$ 587,46	2747301 8.176 0.2%10	1.5/16"	19.71	UNC-9
1"	R\$ 877,73	2747601 12.320 0.2%10	1.1/2"	22.53	UNC-8

MÉTRICO			S (máx.)	H (máx.)	PASSO
M5	R\$ 12,19	3446001 0.104 20%10	8	4.00	0.80
M6	R\$ 15,52	3446101 0.215 10%8	10	5.00	1.00
M8	R\$ 33,06	3446201 0.483 5%10	13	6.50	1.25
M10	R\$ 72,46	3446301 1.013 2%10	17	8.00	1.50
M12	R\$ 106,22	3446401 1.481 1%10	19	10.00	1.75

CÓDIGOS, PREÇOS BRUTOS E PESOS POR CENTO EMBALAGEM MÍNIMA E MASTER.

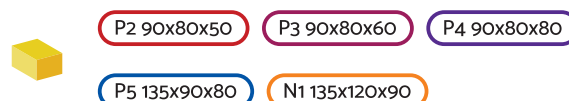

PORCA BORBOLETA ZAMAK LEVE & PESADA

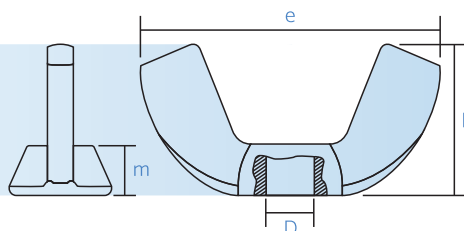

MATERIAL: ZAMAK MACIÇO INJETADO
ACABAMENTO: ZINCADO BRANCO
ROSCA: MÁQUINA UNC/BSW

LEVE		
1/8"	R\$ 61,01	3286901 0.115 10%
5/32"	R\$ 58,19	3287501 0.150 10%
3/16"	R\$ 53,35	2851301 0.175 10%
1/4"	R\$ 97,85	3087401 0.300 10%
5/16"	R\$ 129,86	3087501 0.510 10%
3/8"	R\$ 168,92	3087601 0.775 10%
1/2" BSW	R\$ 365,02	3379701 2.405 5%
1/2" UNC	R\$ 365,02	3287601 2.405 5%

PESADA		
1/8"	R\$ 104,39	3287701 0.280 10%
5/32"	R\$ 97,85	3287801 0.260 10%
3/16"	R\$ 91,81	3087701 0.320 10%
1/4"	R\$ 141,34	3087801 0.550 10%
5/16"	R\$ 284,59	3087901 1.030 10%
3/8"	R\$ 266,57	3088001 1.300 10%

CÓDIGOS, PREÇOS BRUTOS E PESOS POR CENTO EMBALAGEM MÍNIMA E MASTER.

MATERIAL: AÇO BAIXO CARBONO
ACABAMENTO: ZINCADO BRANCO
ROSCA: MÁQUINA UNC/BSW

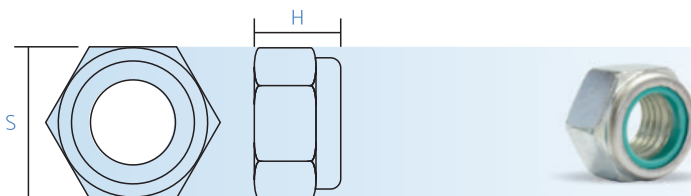

ALTA			S (máx.)	H (máx.)	Rosca - Fio
3/16"	R\$ 30,59	3369801 0.230 10%	3/8"	6.32	UNC-24
1/4"	R\$ 40,30	3369901 0.370 10%	7/16"	8.33	UNC-20
3/8"	R\$ 78,67	3370101 0.833 5%	9/16"	11.91	UNC-16
7/16"	R\$ 113,72	3370301 0.900 5%	5/8"	13.31	UNC-14
1/2"	R\$ 197,68	3370401 1.914 2%	3/4"	15.47	BSW-12
1/2"	R\$ 197,68	3370501 1.914 2%	3/4"	15.47	UNC-13
9/16"	R\$ 310,62	3370601 2.790 2%	7/8"	16.66	UNC-12
5/8"	R\$ 400,26	3370701 3.870 1%	15/16"	19.43	UNC-11
3/4"	R\$ 610,71	3370801 5.942 1%	1.1/8"	22.62	UNC-10
7/8"	R\$ 928,32	3370901 9.456 0.5%	1.5/16"	25.37	UNC-9
1"	R\$ 1.299,08	3371001 11.975 0.5%	1.1/2"	27.38	UNC-8
1.1/8"	R\$ 1.940,56	3371101 0.000 0.25%	1.5/8"	30.00	UNC-7
1.1/4"	R\$ 2.610,18	3371301 24.000 0.25%	1.7/8"	33.50	UNC-7
1.1/2"	R\$ 4.263,28	3371401 0.000 0.10%	2.1/4"	33.50	UNC-6

BAIXA			S (máx.)	H (máx.)	Rosca - Fio
1/4"	R\$ 33,04	3366601 0.274 10%	7/16"	6.50	UNC-20
5/16"	R\$ 52,14	3370001 0.500 5%	1/2"	9.12	UNC-18
3/8"	R\$ 61,98	3366801 0.632 5%	9/16"	9.52	UNC-16
7/16"	R\$ 115,82	3366901 0.853 5%	5/8"	11.11	UNC-20
1/2"	R\$ 157,34	3367001 1.536 2%	3/4"	12.70	BSW-12
1/2"	R\$ 157,34	3367101 1.536 2%	3/4"	12.70	UNC-13
9/16"	R\$ 259,00	3367301 2.400 2%	7/8"	14.29	UNC-12
5/8"	R\$ 304,85	3367401 2.996 1%	15/16"	15.89	UNC-18
3/4"	R\$ 452,36	3367501 4.270 1%	1.1/8"	17.80	UNC-10
7/8"	R\$ 688,37	3367601 0.000 1%	1.5/16"	19.40	UNC-9
1"	R\$ 1.003,06	3367701 10.250 0.5%	1.1/2"	21.50	UNC-8
1.1/4"	R\$ 2.437,50	3367901 0.000 0.25%	1.7/8"	25.50	UNC-7
1.1/2"	R\$ 3.895,80	3368001 0.000 0.25%	2.1/4"	29.00	UNC-6

CÓDIGOS, PREÇOS BRUTOS E PESOS POR CENTO - EMBALAGEM MÍNIMA

APLICAÇÃO

Diversas aplicações, geralmente faz conjunto a parafuso ou barra roscada com a mesma medida de rosca.

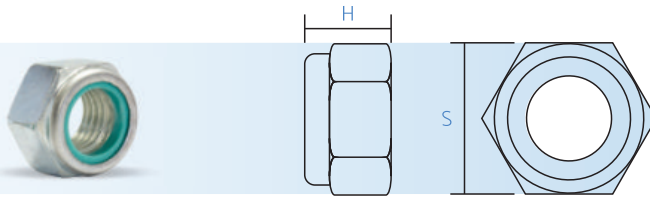

MATERIAL: AÇO BAIXO CARBONO
ACABAMENTO: ZINCADO BRANCO
ROSCA: MÁQUINA UNC/BSW

	ALTA		S (máx.)	H (ref.)	passo
M5	R\$ 24,04	3371501 0.136 10%	8	6.30	0.80
M6	R\$ 32,04	3371601 0.310 10%	10	8.00	1.00
M8	R\$ 60,01	3371701 0.610 10%	13	9.50	1.25
M10	R\$ 127,84	3371801 1.260 2.5%	17	11.50	1.50
M12	R\$ 186,84	3371901 1.836 2%	19	14.00	1.50
M14	R\$ 305,33	3372001 2.100 2%	22	16.00	2.00
M16	R\$ 373,69	3372101 3.620 1%	24	18.00	2.00
M18	R\$ 579,11	3372301 5.160 1%	27	20.00	2.50
M20	R\$ 678,54	3372401 6.800 1%	30	22.00	2.50
M22	R\$ 894,97	3372501 8.600 1%	32	25.00	2.50
M24	R\$ 1.268,57	3372601 12.670 0.5%	36	28.00	3.00

	BAIXA		S (máx.)	H (máx.)	passo
M5	R\$ 16,26	3368101 0.104 10%	8	5.00	0.80
M6	R\$ 21,68	3368301 0.202 10%	10	6.00	1.00
M8	R\$ 48,21	3368401 0.445 10%	13	8.00	1.25
M10	R\$ 107,21	3368501 1.040 0.5%	17	10.00	1.50
M12	R\$ 152,45	3368601 1.546 0.25%	19	12.00	1.75
M14	R\$ 254,81	3368701 2.390 2%	22	14.00	2.00
M16	R\$ 318,62	3367801 2.914 1%	24	16.00	2.00
M18	R\$ 492,79	3369001 4.492 1%	27	18.50	2.50
M20	R\$ 604,81	3369001 6.044 1%	30	20.00	2.50
M22	R\$ 769,67	3369101 6.793 1%	32	22.00	2.50
M24	R\$ 1.030,59	3369301 10.906 0.5%	36	24.00	3.00
M27	R\$ 1.759,44	3369401 0.000 0.25%	41	27.00	3.00
M30	R\$ 2.211,14	3369501 0.000 0.25%	46	30.00	3.50
M33	R\$ 3.022,94	3369601 0.000 0.10%	50	33.00	3.50
M36	R\$ 3.867,39	3369701 0.000 0.10%	55	36.00	4.00

CÓDIGOS, PREÇOS BRUTOS E PESOS POR CENTO EMBALAGEM MÍNIMA

PORCA GARRA



MATERIAL: ZAMAK MACIÇO INJETADO
ACABAMENTO: ZINCADO BRANCO
ROSCA: MÁQUINA UNC/BSW

1/4"	R\$	60,80	2248701 0.340 5%
------	-----	-------	------------------------

CÓDIGOS, PREÇOS BRUTOS E PESOS POR CENTO - EMBALAGEM MÍNIMA E MASTER.

MATERIAL: AÇO BAIXO CARBONO
ACABAMENTO: ZINCADO BRANCO
ROSCA: MÁQUINA UNC/BSW



M6	R\$	CONSULTE	3131701
M8	R\$	CONSULTE	3131801
M10	R\$	CONSULTE	3099101
M12	R\$	CONSULTE	3142101

ARRUELA LISA LEVE

MATERIAL: AÇO SAE 1008/1010
ACABAMENTO: ZINCADO BRANCO
NCM: 7318.22.00
IPI: 10%

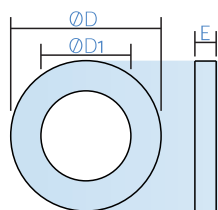

POLEGADA			E (máx.)	ØD1 (ref.)	ØD (ref.)	
1/8"	R\$	137,75	2984401 1KG	0,80	3,50	10,90
5/32"	R\$	123,25	2984501 1KG	0,80	4,50	10,00
5/32"	R\$	123,25	3155101 1KG	0,80	4,50	14,00
3/16"	R\$	94,25	2984601 1KG	0,90	5,50	15,00
1/4"	R\$	90,63	2984701 1KG	0,95	7,00	18,00
5/16"	R\$	90,63	2984801 1KG	1,10	8,80	20,00
3/8"	R\$	87,00	2984901 1KG	1,50	10,50	25,00
7/16"	R\$	87,00	2985001 1KG	2,80	12,00	28,00
1/2"	R\$	87,00	2985101 1KG	2,80	13,50	32,00
9/16"	R\$	87,00	2985201 1KG	3,00	15,50	34,00
5/8"	R\$	87,00	2985301 1KG	3,00	17,00	38,00
3/4"	R\$	87,00	2985401 1KG	3,10	21,00	44,00
7/8"	R\$	87,00	2985501 1KG	3,10	24,00	50,00
1"	R\$	87,00	2985601 1KG	3,10	27,00	56,00
1.1/4"	R\$	87,00	81070101 1KG	3,20	33,00	65,00
1.1/2"	R\$	87,00	81075101 1KG	3,20	40,00	74,00

MÉTRICA			E (máx.)	ØD1 (ref.)	ØD (ref.)	
M3	R\$	509,64	80610101 1KG	0,90	3,20	7,00
M4	R\$	286,34	80615101 1KG	1,00	4,30	9,00
M5	R\$	275,90	3026201 1KG	1,00	5,20	10,00
M6	R\$	200,61	3026301 1KG	1,20	6,20	12,70
M8	R\$	123,72	3026501 1KG	2,00	8,50	17,30
M10	R\$	95,45	3026601 1KG	2,00	10,30	21,30
M12	R\$	89,50	3026701 1KG	2,65	12,80	25,50
M14	R\$	94,90	3026801 1KG	2,65	14,70	28,00
M16	R\$	94,00	3026401 1KG	3,00	16,70	30,00
M18	R\$	92,37	3026901 1KG	3,00	19,00	34,00
M20	R\$	98,31	3027001 1KG	3,00	21,00	37,00
M22	R\$	103,02	3024801 1KG	3,00	22,90	38,00
M24	R\$	130,75	2999901 1KG	3,00	24,80	44,30

CÓDIGOS, PREÇOS BRUTOS E PESOS POR QUILO
EMBALAGEM MÍNIMA

APLICAÇÃO



Utilizadas como complemento a outros fixadores, principalmente parafusos

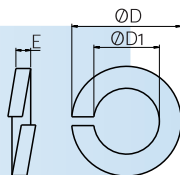

MATERIAL: AÇO SAE 1008/1010
ACABAMENTO: ZINCADO BRANCO
NCM: 7318.21.00
IPI: 10%

POLEGADA			E (máx.)	ØD1 (ref.)	ØD (ref.)
1/8"	R\$ 27,88	3121401 1ML	0,80	3,25	6,00
5/32"	R\$ 38,20	3121501 1ML	1,10	4,27	7,45
3/16"	R\$ 46,46	3121601 1ML	1,20	4,93	8,47
1/4"	R\$ 64,02	3121701 1ML	1,20	6,20	11,28
5/16"	R\$ 110,99	80020101 1ML	1,50	8,10	13,55
3/8"	R\$ 170,36	80025101 1ML	1,70	9,70	15,78
1/2"	R\$ 305,62	80035101 1ML	2,00	12,93	20,69
5/8"	R\$ 511,09	3040401 1ML	2,40	16,15	24,88
3/4"	R\$ 740,30	3121801 1ML	2,50	19,38	29,39
7/8"	R\$ 1.110,97	3121901 1ML	3,00	22,61	33,67
1"	R\$ 1.734,60	3122001 1ML	3,50	25,83	38,51

MÉTRICA			E (máx.)	ØD1 (ref.)	ØD (ref.)
M3	R\$ 27,36	2995801 1ML	1,00	3,20	5,60
M4	R\$ 43,98	81615100C 1ML	1,15	4,20	7,00
M5	R\$ 48,53	81620100C 1ML	1,60	5,20	8,80
M6	R\$ 92,93	80125101 1ML	1,60	6,20	9,90
M8	R\$ 170,36	80135101 1ML	2,00	8,20	12,70
M10	R\$ 261,22	80140101 1ML	2,50	10,20	16,00
M12	R\$ 416,10	80145101 1ML	2,60	12,20	18,00
M14	R\$ 681,45	80150101 1ML	3,00	14,20	21,10
M16	R\$ 999,46	80155101 1ML	3,50	16,20	24,40
M18	R\$ 1.084,13	2995901 1ML	3,60	18,20	26,40
M20	R\$ 1.755,25	2996001 1ML	4,50	20,20	30,60

CÓDIGOS, PREÇOS BRUTOS E PESOS POR MILHEIRO.

ARRUELA FUNILEIRO

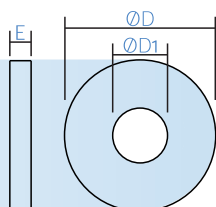

MATERIAL: AÇO SAE 1008/1010
ACABAMENTO: ZINCADO BRANCO
NCM: 7318.22.00
IPI: 10%

			E (máx.)	ØD1 (ref.)	ØD (ref.)
3/16"	R\$ 72,28	12003 1KG	1,50	5,00	29,00
1/4"	R\$ 69,69	12004 1KG	2,00	6,60	32,00
5/16"	R\$ 67,11	12005 1KG	2,00	8,00	36,20
3/8"	R\$ 64,53	12006 1KG	2,00	10,30	37,20
7/16"	R\$ 63,50	12007 1KG	2,00	11,30	40,00
1/2"	R\$ 64,02	12008 1KG	2,00	13,30	40,40
5/8"	R\$ 81,57	12009 1KG	3,50	16,50	52,00

CÓDIGOS, PREÇOS BRUTOS E PESOS POR QUILO.

APLICAÇÃO

Utilizadas como complemento a outros fixadores, principalmente parafusos. A aba maior proporciona mais firmeza e melhor acabamento.

MATERIAL: AÇO BAIXO CARBONO
ACABAMENTO: POLIDO/ZINCADO BRANCO
ROSCA: MÁQUINA UNC/BSW

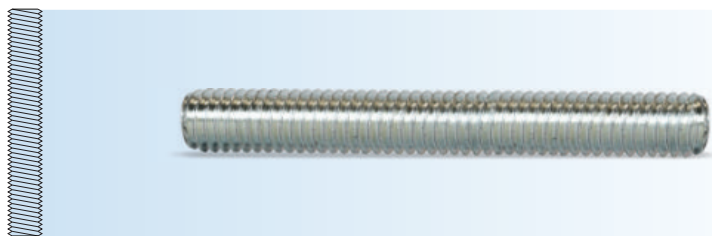

POLEGADA - POLIDA COM 1 MT			Fios P.P.
3/16"	R\$	5,39	2857301 0.100 UNC-24
1/4"	R\$	7,30	2857401 0.180 UNC-20
5/16"	R\$	11,71	2857501 0.290 UNC-18
3/8"	R\$	17,28	2857601 0.426 UNC-16
1/2"	R\$	30,66	2730601 0.750 BSW-12
1/2"	R\$	30,66	2857801 0.750 UNC-13
5/8"	R\$	53,77	2857901 1.250 UNC-11
3/4"	R\$	79,60	2858001 1.867 UNC-10
7/8"	R\$	107,99	2858101 2.500 UNC-9
1"	R\$	141,64	2858201 3.300 UNC-8
1.1/4"	R\$	313,20	3442001 4.200 UNC-7

POLEGADA - ZINCADA COM 1 MT			Fios P.P.
3/16"	R\$	6,06	2241001 0.100 UNC-24
1/4"	R\$	8,50	2252501 0.180 UNC-20
5/16"	R\$	13,69	2252601 0.290 UNC-18
3/8"	R\$	20,14	2252701 0.426 UNC-16
1/2"	R\$	35,94	2252901 0.750 BSW-12
1/2"	R\$	35,94	2252801 0.750 UNC-13
5/8"	R\$	63,51	2253001 1.250 UNC-11
3/4"	R\$	94,02	2253101 1.867 UNC-10
7/8"	R\$	127,59	2253201 2.500 UNC-9
1"	R\$	167,26	2253301 3.300 UNC-8
1.1/4"	R\$	367,92	2254001 4.200 UNC-7

POLEGADA - ZINCADA COM 3 MT			Fios P.P.
1/4"	R\$	23,45	2241001 0.540 UNC-20
5/16"	R\$	37,74	2241201 0.870 UNC-18
3/8"	R\$	55,54	2241301 1.278 UNC-16
1/2"	R\$	98,58	2241401 2.250 UNC-13
1/2"	R\$	98,58	2241501 2.250 BSW-12
5/8"	R\$	172,46	2241601 3.750 UNC-11
3/4"	R\$	255,43	2241701 5.601 UNC-10
7/8"	R\$	346,32	2241801 7.500 UNC-9
1"	R\$	454,37	2242001 9.900 UNC-8

MÉTRICA - ZINCADA COM 1 MT			Passo
M5	R\$	9,90	24420101 1.030 0,8
M6	R\$	11,54	24425101 1.200 1,0
M8	R\$	19,80	24435101 2.060 1,25
M10	R\$	31,15	24440101 3.240 1,5
M12	R\$	45,76	24445101 4.760 1,75
M14	R\$	62,78	24450101 6.530 2
M16	R\$	85,85	24455101 8.930 2
M18	R\$	106,33	24460101 11.060 2,5
M20	R\$	134,98	24465101 14.040 2,5
M22	R\$	170,36	24470101 17.720 2,5
M24	R\$	197,47	24475101 20.540 3,0

CÓDIGOS, PREÇOS BRUTOS E PESOS POR PEÇA

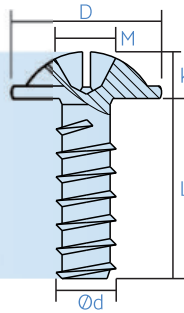

MATERIAL: AÇO SAE 1015
ACABAMENTO: ZINCADO BRANCO
ROSCA: AUTO CORTANTE

Diâmetro	3,0		3,5		4,0		4,5		5,0	
D (máx.)	7,80		8,50		9,50		10,80		12,00	
k (máx.)	1,48		1,80		1,98		2,29		2,70	
m (ref.)	2		2		2		2		2	
passo	1,35		1,60		1,80		2,00		2,20	
L (mm)										
8	R\$ 8,68	2779501 0,057 5%20	R\$ 9,63	2776701 0,084 5%20	R\$ 11,47	2777701 0,106 5%20			R\$ 21,58	2168601 0,181 5%10
10	R\$ 8,86	2167401 0,058 5%20	R\$ 11,00	2254701 0,088 5%20	R\$ 12,42	2777801 0,116 5%20			R\$ 22,71	3206101 0,212 5%10
12	R\$ 9,87	2776301 0,064 5%20	R\$ 12,01	2776901 0,096 5%20	R\$ 13,49	2777901 0,126 5%20	R\$ 18,67	2800901 0,157 5%10	R\$ 23,90	2778701 0,219 5%10
14	R\$ 9,93	2776401 0,072 5%20	R\$ 13,02	2777001 0,102 5%20	R\$ 14,33	2778001 0,137 5%20	R\$ 19,80	2801001 0,168 5%10	R\$ 25,32	2778801 0,233 5%10
16	R\$ 9,99	2776501 0,082 5%20	R\$ 13,32	2777101 0,116 5%20	R\$ 15,16	2778101 0,142 5%20	R\$ 22,53	2801101 0,183 5%10	R\$ 26,81	2778901 0,250 5%10
20	R\$ 12,54	2167501 0,088 5%20	R\$ 14,80	2777201 0,120 5%20	R\$ 17,30	2778201 0,170 5%10	R\$ 23,66	2801201 0,200 5%10	R\$ 30,79	2779001 0,288 5%10
22	R\$ 13,79	2776601 0,091 5%20	R\$ 15,93	2777301 0,128 5%10	R\$ 18,61	2778301 0,182 5%10	R\$ 24,97	2801301 0,211 5%10	R\$ 32,58	2801401 0,295 5%10
25	R\$ 15,04	2167601 0,100 5%10	R\$ 16,29	2777401 0,140 5%10	R\$ 19,26	2778401 0,188 5%10	R\$ 25,32	2168001 0,239 5%10	R\$ 33,83	2752801 0,310 5%10
30	R\$ 16,94	2167701 0,118 5%10	R\$ 18,13	2777501 0,160 5%10	R\$ 22,83	2778501 0,214 5%10	R\$ 28,36	2168101 0,287 5%10	R\$ 35,07	2779101 0,347 5%10
35			R\$ 20,27	2777601 0,184 5%10	R\$ 24,97	2778601 0,244 5%10	R\$ 30,08	2168201 0,296 5%10	R\$ 37,99	2779201 0,380 5%10
40			R\$ 21,52	2167801 0,220 5%10	R\$ 26,63	2167901 0,270 5%10	R\$ 33,88	2168301 0,348 5%10	R\$ 41,55	2779301 0,480 5%10
45							R\$ 35,73	2168401 0,374 5%10	R\$ 43,51	2801601 0,495 5%10
50							R\$ 39,17	2168501 0,399 5%8	R\$ 46,78	2801701 0,562 5%10

CÓDIGOS, PREÇOS BRUTOS E PESOS POR CENTO - EMBALAGEM MÍNIMA E MASTER.



P2 90x80x50

P3 90x80x60

P4 90x80x80

P5 135x90x80

N1 135x120x90

Consulte lote mínimo

APLICAÇÃO

Utilizados na fixação de componentes plásticos.

MATERIAL: AÇO SAE 1015
ACABAMENTO: ZINCADO BRANCO
ROSCA: AUTO CORTANTE

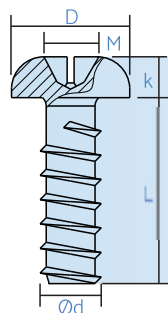

Diâmetro	3,0		3,5		4,0		4,5		5,0	
D (máx.)	5,50		6,90		7,50		8,20		9,50	
k (máx.)	2,34		2,60		2,80		3,05		3,55	
m (ref.)	2		2		2		2		2	
passo	1,35		1,60		1,80		2,00		2,20	
L (mm)										
8	R\$ 6,98	34525701 0,052 5%20	R\$ 9,51	34535701 0,078 5%20	R\$ 11,76	34550701 0,087 5%20				
10	R\$ 7,34	34526001 0,057 5%10	R\$ 10,02	34536001 0,085 5%20	R\$ 12,13	34551001 0,104 5%20				
12	R\$ 7,82	34526201 0,060 5%20	R\$ 10,07	34536201 0,089 5%20	R\$ 12,78	3009501 0,126 5%20	R\$ 16,63	3065301 0,154 5%10	R\$ 23,51	3066401 0,220 5%10
14	R\$ 8,43	34526401 0,073 5%20	R\$ 10,94	34536401 0,098 5%20	R\$ 13,40	34551401 0,132 5%20	R\$ 17,51	3065401 0,168 5%10	R\$ 24,75	34571401 0,220 5%10
16	R\$ 8,95	34526601 0,074 5%20	R\$ 11,50	34536601 0,106 5%20	R\$ 14,41	34551601 0,136 5%20	R\$ 17,72	3065501 0,190 5%10	R\$ 26,05	34571601 0,244 5%10
20	R\$ 9,97	34526901 0,086 5%20	R\$ 13,49	34536901 0,124 5%20	R\$ 16,25	34551901 0,156 5%10	R\$ 19,78	3065601 0,221 5%10	R\$ 27,42	34571901 0,266 5%10
22	R\$ 10,56	3064901 0,096 5%20	R\$ 14,24	3065001 0,124 5%20	R\$ 16,69	3065201 0,165 5%10	R\$ 20,91	3065701 0,231 5%10	R\$ 28,87	34572001 0,282 5%10
25	R\$ 12,14	34527101 0,100 5%10	R\$ 15,39	34537101 0,140 5%10	R\$ 17,79	34552101 0,186 5%10	R\$ 22,95	3065801 0,254 5%10	R\$ 30,39	34572101 0,311 5%10
30	R\$ 13,16	34527201 0,114 5%10	R\$ 16,87	34537201 0,167 5%10	R\$ 20,73	34552201 0,202 5%10	R\$ 27,07	3065901 0,275 5%10	R\$ 32,39	34572201 0,332 5%10
35			R\$ 18,68	34537401 0,186 5%10	R\$ 22,11	34552401 0,244 5%10	R\$ 28,09	3066001 0,318 5%10	R\$ 36,48	34572401 0,392 5%10
40			R\$ 21,47	3065101 0,192 5%10	R\$ 25,41	34552601 0,256 5%10	R\$ 30,31	3066101 0,368 5%10	R\$ 39,03	34572601 0,422 5%8
45							R\$ 33,11	3066201 0,395 5%8	R\$ 41,89	3066501 0,442 5%10
50							R\$ 36,60	3066301 0,464 5%8	R\$ 46,40	34572801 0,519 5%10

CÓDIGOS, PREÇOS BRUTOS E PESOS POR CENTO - EMBALAGEM MÍNIMA E MASTER.



P2 90x80x50

P3 90x80x60

P4 90x80x80

P5 135x90x80

N1 135x120x90

Consulte lote mínimo

APLICAÇÃO



Utilizados na fixação de componentes plásticos.



CHIP-FIX

DESENVOLVIDO ESPECIALMENTE PARA A INDÚSTRIA MOVELEIRA, UTILIZADO NA FABRICAÇÃO DE MÓVEIS EM MADEIRAS LEVES (PINUS, AGLOMERADOS, COMPENSADOS E ETC).

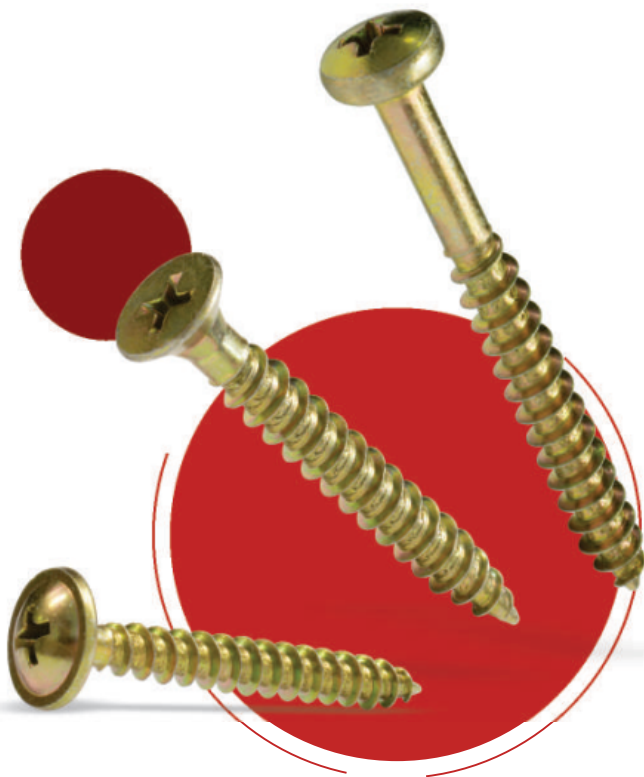

CHATA PHILIPS



PANELA PHILIPS



FLANGEADA PHILIPS



TORX



SEXTAVADO FLANGEADO



REBAIXADA



PHILIPS 3*

*PHILIPS 3 DISPONÍVEL NO DIÂMETRO DE 6,0, CONSULTE LOTE MÍNIMO.

MADE-FIX



CHATA SIMPLES



CHATA PHILIPS



TAMPINHA PHILIPS

CONSULTE EM OUTROS ACABAMENTOS

ZINCADO BRANCO - OXIDADO - NIQUELADO - ZINCADO PRETO - POLIDO

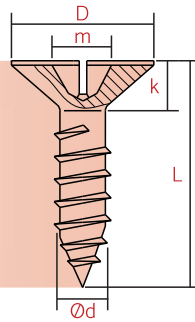

MATERIAL: AÇO SAE 1015/1018
TRATAMENTO: CEMENTADO
ACABAMENTO: BICROMATIZADO
ROSCA: AUTO CORTANTE

Diâmetro	3,0		3,5		4,0		4,5		5,0		6,0	
D (máx.)	6,20		6,80		7,50		8,10		9,50		10,80	
k (ref.)	1,90		2,10		2,30		2,70		2,90		3,20	
m (ref.)	2		2		2		2		2		2&3*	
passo	1,35		1,60		1,80		2,00		2,20		2,60	
L (mm)												
10	R\$ 5,81	2132401 0,043 5%20	R\$ 7,31	2133301 0,055 5%20								
12	R\$ 6,12	2132501 0,048 5%20	R\$ 7,50	2133401 0,064 5%20	R\$ 9,32	2134501 0,083 5%20						
14	R\$ 6,62	2132601 0,055 5%20	R\$ 8,05	2133601 0,075 5%20	R\$ 9,91	2134601 0,094 5%20	R\$ 13,81	2135701 0,105 5%10				
16	R\$ 6,93	2132701 0,061 5%20	R\$ 8,48	2133701 0,082 5%20	R\$ 10,61	2134701 0,100 5%20	R\$ 13,95	2135801 0,121 5%10				
20	R\$ 7,55	2132801 0,074 5%20	R\$ 9,91	2133801 0,095 5%20	R\$ 12,69	2134801 0,121 5%10	R\$ 15,60	2135901 0,142 5%10				
22	R\$ 8,48	2132901 0,081 5%20	R\$ 10,80	2133901 0,101 5%10	R\$ 13,00	2134901 0,137 5%10	R\$ 16,51	2136001 0,156 5%10	R\$ 23,42	2741601 0,215 5%10		
25	R\$ 9,79	2133001 0,084 5%10	R\$ 11,49	2134001 0,115 5%10	R\$ 14,55	2135001 0,153 5%10	R\$ 18,28	2136101 0,177 5%10	R\$ 23,44	2136801 0,235 5%10	R\$ 38,75	2137701 0,342 5%10
30	RP R\$ 10,80	2133101 0,104 5%10	R\$ 12,64	2134101 0,138 5%10	R\$ 16,77	2135101 0,174 5%10	R\$ 20,76	2136201 0,211 5%10	R\$ 26,04	2136901 0,277 5%10	R\$ 38,77	2137801 0,412 5%10
35	RP		R\$ 14,64	2134201 0,158 5%10	R\$ 18,71	2135201 0,197 5%10	R\$ 23,34	2136301 0,238 5%10	R\$ 28,50	2137001 0,294 5%10	R\$ 43,26	2137901 0,467 5%8
40	RP		R\$ 16,13	2134401 0,176 5%10	R\$ 20,35	2135301 0,228 5%10	R\$ 25,35	2136401 0,269 5%10	R\$ 31,70	2137101 0,352 5%8	R\$ 47,13	2138001 0,508 2%10
45	RP		R\$ 18,16	3431501 0,218 5%10	R\$ 23,34	2135401 0,255 5%10	R\$ 28,19	2136501 0,304 5%8	R\$ 34,90	2137201 0,389 2%10	R\$ 51,60	2138101 0,587 2%10
50	RP				R\$ 26,04	2135501 0,280 5%8	R\$ 29,24	2136601 0,338 5%8	R\$ 38,03	2137301 0,428 2%10	R\$ 56,74	2138201 0,637 2%10
60	RP				R\$ 30,96	2135601 0,334 2%10	R\$ 34,69	2136701 0,399 2%10	R\$ 42,33	2137401 0,511 2%10	R\$ 65,41	2138301 0,771 2%8
65	RP						R\$ 37,58	3176201 0,416 2%8	R\$ 47,68	3231101 0,550 1%10	R\$ 69,97	3007101 0,800 2%8
70	RP								R\$ 53,06	2137501 0,588 1%10	R\$ 74,51	2138401 0,892 1%10
80	RP								R\$ 58,31	2137601 0,672 1%10	R\$ 81,87	2138501 0,995 1%10
90	RP								R\$ 65,60	3289901 0,760 1%8	R\$ 92,12	39183502 1,100 1%8
100	RP										R\$ 102,24	3225001 1,232 1%8

CÓDIGOS, PREÇOS BRUTOS E PESOS POR CENTO - EMBALAGEM MÍNIMA E MASTER.

* FENDA 3 DISPONÍVEL NA ESPESSURA DE 6,0, CONSULTE LOTE MÍNIMO

- P2 90x80x50
- P3 90x80x60
- P4 90x80x80
- P5 135x90x80
- N1 135x120x90
- Consulte lote minimo

APLICAÇÃO

Desenvolvido especialmente para a indústria moveleira, utilizado na fabricação de móveis em madeiras leves (pinus, aglomerados, compensados e etc).

MATERIAL: AÇO SAE 1015/1018
TRATAMENTO: CEMENTADO
ACABAMENTO: BICROMATIZADO
ROSCA: AUTO CORTANTE

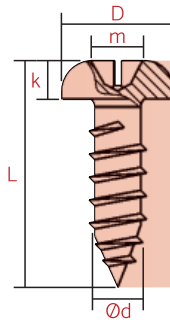

Diâmetro	3,0		3,5		4,0		4,5		5,0		6,0							
D (máx.)	5,50		6,90		7,50		8,20		9,50		10,80							
k (máx.)	2,34		2,60		2,80		3,05		3,55		3,95							
m (ref.)	2		2		2		2		2		2&3*							
passo	1,35		1,60		1,80		2,00		2,20		2,60							
L (mm)																		
10	R\$	6,86	2143601 0,049 5%20	R\$	9,36	2144401 0,079 5%20												
12	R\$	7,31	2143701 0,059 5%20	R\$	9,41	2144501 0,083 5%20	R\$	11,91	2145401 0,107 5%20									
14	R\$	7,88	2143801 0,068 5%20	R\$	10,22	2144601 0,092 5%20	R\$	12,52	2145501 0,114 5%20	R\$	16,36	2146501 0,147 5%10						
16	R\$	8,36	2143901 0,071 5%20	R\$	10,75	2144701 0,100 5%20	R\$	13,47	2145601 0,131 5%20	R\$	16,56	2146601 0,160 5%10						
20	R\$	9,32	2144001 0,082 5%20	R\$	12,61	2144801 0,117 5%20	R\$	15,19	2145701 0,145 5%10	R\$	18,49	2146701 0,181 5%10						
22	R\$	9,87	2144101 0,091 5%20	R\$	13,31	2144901 0,122 5%10	R\$	15,60	2145801 0,160 5%10	R\$	19,54	2146801 0,210 5%10						
25	R\$	11,35	2144301 0,095 5%10	R\$	14,38	2145001 0,137 5%10	R\$	16,63	2145901 0,171 5%10	R\$	21,45	2146901 0,220 5%10	R\$	28,40	2147601 0,286 5%10	R\$	43,07	2148301 0,435 5%10
30	RP	12,30	2144301 0,115 5%10	R\$	15,77	2145101 0,157 5%10	R\$	19,37	2146001 0,180 5%10	R\$	25,30	2147001 0,242 5%10	R\$	30,27	2147701 0,330 5%10	R\$	45,34	2767101 0,509 5%10
35	RP			R\$	17,46	2145201 0,176 5%10	R\$	20,66	2146101 0,225 5%10	R\$	26,25	2147101 0,262 5%10	R\$	34,09	2147801 0,371 5%10	R\$	48,57	2767201 0,554 5%8
40	RP			R\$	20,07	2145301 0,194 5%10	R\$	23,75	2146201 0,255 5%10	R\$	28,33	2147201 0,303 5%10	R\$	36,48	2147901 0,418 5%8	R\$	52,79	2148401 0,563 2%10
45	RP						R\$	25,51	2146301 0,282 5%10	R\$	30,94	2147301 0,350 5%8	R\$	39,15	2148001 0,438 2%10	R\$	58,38	2148501 0,681 2%10
50	RP						R\$	27,26	2146401 0,298 5%8	R\$	34,21	2147401 0,376 5%8	R\$	43,36	2148101 0,499 2%10	R\$	63,38	2148601 0,728 2%10
60	RP						R\$	31,89	2735101 0,366 2%10	R\$	37,08	2147501 0,442 2%10	R\$	47,42	2148201 0,555 2%10	R\$	71,21	2148701 0,871 2%8
70	RP											R\$	60,13	2734901 0,658 1%10	R\$	81,56	2767301 0,934 1%10	
80	RP											R\$	74,77	2735001 0,746 1%10	R\$	102,44	2767401 1,084 1%10	

CÓDIGOS, PREÇOS BRUTOS E PESOS POR CENTO - EMBALAGEM MÍNIMA E MASTER.

* FENDA 3 DISPONÍVEL NA ESPESSURA DE 6,0, CONSULTE LOTE MÍNIMO



P2 90x80x50

P3 90x80x60

P4 90x80x80

P5 135x90x80

N1 135x120x90

Consulte lote mínimo

APLICAÇÃO

Desenvolvido especialmente para a indústria moveleira, utilizado na fabricação de móveis em madeiras leves (pinus, aglomerados, compensados e etc).

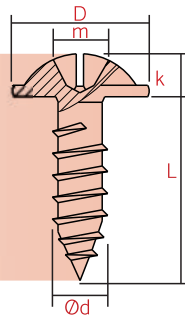
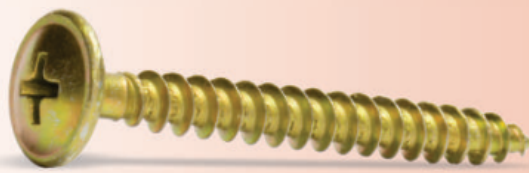

MATERIAL: AÇO SAE 1015/1018
TRATAMENTO: CEMENTADO
ACABAMENTO: BICROMATIZADO
ROSCA: AUTO CORTANTE

Diâmetro	3,0		3,5		4,0		4,5		5,0		6,0	
D (máx.)	7,80		8,50		9,50		10,80		12,00		13,00	
k (ref.)	1,50		1,80		1,98		2,30		2,70		2,80	
m (ref.)	2		2		2		2		2		2&3*	
passo	1,35		1,60		1,80		2,00		2,20		2,60	
L (mm)												
10	R\$ 8,27	2149301 0,057 5%20	R\$ 10,25	3007701 0,072 5%20								
12	R\$ 9,22	2149401 0,061 5%20	R\$ 10,27	2150101 0,080 5%20	R\$ 12,61	2151201 0,106 5%20						
14	R\$ 9,27	2149501 0,066 5%20	R\$ 12,18	2150201 0,098 5%20	R\$ 13,38	2151301 0,122 5%20						
16	R\$ 9,32	2149601 0,075 5%20	R\$ 12,47	2150301 0,105 5%20	R\$ 14,14	2151401 0,126 5%20	R\$ 21,05	2152301 0,170 5%10				
20	R\$ 11,73	2149701 0,083 5%20	R\$ 13,81	2150401 0,120 5%20	R\$ 16,20	2151501 0,152 5%10	R\$ 22,15	2152401 0,183 5%10	R\$ 28,76	2153301 0,230 5%10		
22	R\$ 12,88	2149801 0,094 5%20	R\$ 14,86	2150501 0,122 5%10	R\$ 17,42	2151601 0,161 5%10	R\$ 23,34	2152501 0,198 5%10				
25	R\$ 14,07	2149901 0,100 5%10	R\$ 15,19	2150601 0,136 5%10	R\$ 17,99	2151701 0,177 5%10	R\$ 23,65	2152601 0,223 5%10	R\$ 30,27	2153401 0,288 5%10	R\$ 46,44	2770501 0,369 5%10
30	R\$ 15,81	2150001 0,114 5%10	R\$ 16,94	2150701 0,149 5%10	R\$ 21,36	2151801 0,208 5%10	R\$ 26,47	2152701 0,253 5%10	R\$ 32,80	2153501 0,348 5%10	R\$ 53,80	2770601 0,479 5%8
35			R\$ 18,97	2150801 0,169 5%10	R\$ 23,34	2151901 0,241 5%10	R\$ 28,12	2152801 0,297 5%10	R\$ 35,48	2153601 0,375 5%8	R\$ 56,54	2878101 0,540 5%8
40			R\$ 20,14	2151101 0,267 5%10	R\$ 24,92	2152001 0,267 5%10	R\$ 31,70	2152901 0,333 5%8	R\$ 38,84	2153701 0,401 5%8	R\$ 59,99	2768601 0,589 2%10
45					R\$ 26,68	2152101 0,283 5%8	R\$ 33,40	2153001 0,344 5%8	R\$ 40,68	2153801 0,434 2%10	R\$ 64,45	2154001 0,653 2%10
50					R\$ 29,55	2152201 0,296 5%8	R\$ 36,60	2153101 0,370 5%8	R\$ 43,72	2153901 0,478 2%10	R\$ 70,46	2250701 0,704 2%10
55									R\$ 48,39	3227801 0,495 2%8		
60							R\$ 41,38	2153201 0,441 2%10	R\$ 53,06	2254101 0,508 2%8	R\$ 74,94	2154101 0,906 2%8
70									R\$ 62,09	3291201 0,650 2%8		

CÓDIGOS, PREÇOS BRUTOS E PESOS POR CENTO - EMBALAGEM MÍNIMA E MASTER.

* FENDA 3 DISPONÍVEL NA ESPESSURA DE 6,0, CONSULTE LOTE MÍNIMO



P2 90x80x50

P3 90x80x60

P4 90x80x80

P5 135x90x80

N1 135x120x90

Consulte lote mínimo

APLICAÇÃO

Desenvolvido especialmente para a indústria moveleira, utilizado na fabricação de móveis em madeiras leves (pinus, aglomerados, compensados e etc).

MATERIAL: AÇO BAIXO CARBONO
ACABAMENTO: ZINCADO BRANCO
ROSCA: SOBERBA

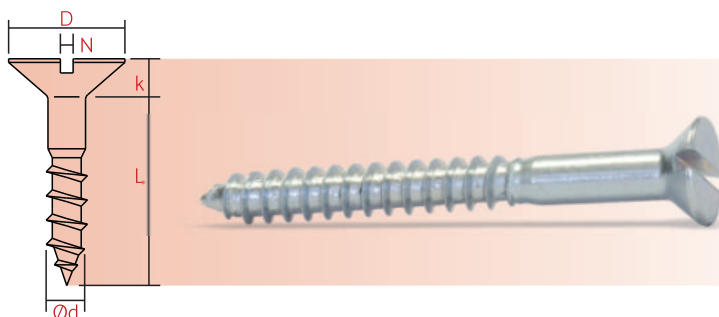

Diâmetro	2,5	2,8	3,2	3,5	3,8	4,2	4,5	4,8	5,5	6,1
D (máx.)	5,00	5,60	6,40	7,10	7,70	8,10	9,10	9,70	11,10	12,70
k (ref.)	1,50	1,70	1,90	2,10	2,30	2,50	2,70	2,90	3,30	3,70
N (máx.)	0,90	1,00	1,20	1,30	1,30	1,40	1,50	1,60	1,80	2,00
passo	1,06	0,91	1,27	1,41	1,59	1,69	1,81	1,95	2,31	2,54
L (mm)										
10	R\$ 5,49 2156001 0.031 5%20	R\$ 6,36 2156601 0.039 5%20								
12	R\$ 6,08 2156101 0.034 5%20	R\$ 7,08 2156701 0.051 5%20	R\$ 7,54 2157401 0.064 5%20	R\$ 8,95 2158101 0.078 5%20	R\$ 11,55 2158901 0.088 5%10					
16	R\$ 6,45 2156201 0.047 5%20	R\$ 7,63 2156801 0.060 5%20	R\$ 8,59 2157501 0.078 5%20	R\$ 10,46 2158201 0.098 5%10	R\$ 11,64 2159001 0.110 5%10	R\$ 14,74 2159801 0.140 5%10	R\$ 17,72 2160901 0.179 5%10	R\$ 20,93 3009601 0.210 5%10		
20	R\$ 7,31 2156301 0.055 5%20	R\$ 8,59 2156901 0.068 5%20	R\$ 9,59 2157601 0.097 5%10	R\$ 11,37 2158301 0.116 5%10	R\$ 13,37 2159101 0.130 5%10	R\$ 15,01 2159901 0.172 5%10	R\$ 18,09 2161001 0.201 5%10	R\$ 21,00 2162001 0.227 5%10	R\$ 31,50 2163201 0.300 5%10	
22	R\$ 8,27 2156401 0.062 5%20	R\$ 9,18 2157001 0.072 5%20	R\$ 10,23 2157701 0.100 5%10	R\$ 12,92 2158401 0.127 5%10	R\$ 15,24 2159201 0.143 5%10	R\$ 16,45 2160001 0.183 5%10	R\$ 19,04 2161101 0.232 5%10	R\$ 21,14 2162101 0.249 5%10	R\$ 32,64 2163301 0.326 5%10	R\$ 41,46 2164501 0.454 2%10
25	R\$ 9,41 2156501 0.067 5%20	R\$ 10,46 2157101 0.083 5%20	R\$ 11,96 2157801 0.113 5%10	R\$ 13,83 2158501 0.144 5%10	R\$ 16,72 2159301 0.156 5%10	R\$ 18,09 2160101 0.197 5%10	R\$ 21,78 2161201 0.241 5%10	R\$ 24,10 2162201 0.278 5%10	R\$ 33,64 2163401 0.356 5%10	R\$ 42,23 2164601 0.503 2%10
30 ^{RP}		R\$ 11,78 2157201 0.109 5%10	R\$ 14,15 2157901 0.147 5%10	R\$ 17,13 2158601 0.183 5%10	R\$ 19,32 2159401 0.218 5%10	R\$ 22,73 2160201 0.256 5%10	R\$ 26,72 2161301 0.307 5%10	R\$ 28,09 2162301 0.351 5%10	R\$ 37,72 2163501 0.468 2%10	R\$ 50,41 2164701 0.624 2%10
40 ^{RP}		R\$ 14,97 2157301 0.135 5%10	R\$ 18,40 2158001 0.187 5%10	R\$ 19,59 2158701 0.234 5%10	R\$ 22,14 2159501 0.270 5%10	R\$ 25,83 2160301 0.323 5%10	R\$ 30,27 2161401 0.406 2%10	R\$ 33,87 2162401 0.459 2%10	R\$ 44,96 2163701 0.596 2%10	R\$ 56,92 2164801 0.775 2%10
45 ^{RP}				R\$ 21,46 2158801 0.286 5%10	R\$ 25,24 2159601 0.313 5%10	R\$ 30,00 2160401 0.372 2%10	R\$ 34,05 2161501 0.451 2%10	R\$ 37,58 2162501 0.501 2%10	R\$ 49,95 2163801 0.667 2%10	R\$ 63,46 2164901 0.859 2%10
50 ^{RP}				R\$ 23,83 3176301 0.305 5%10	R\$ 27,54 2159701 0.342 5%8	R\$ 32,23 2160501 0.410 2%10	R\$ 37,33 2161601 0.504 2%10	R\$ 41,82 2162601 0.552 2%10	R\$ 56,51 2163901 0.719 2%10	R\$ 70,63 2165001 0.951 2%10
55 ^{RP}					R\$ 30,29 2765701 0.384 5%10	R\$ 38,45 2160601 0.447 2%10	R\$ 45,05 2161701 0.528 2%10	R\$ 50,41 2162701 0.607 2%10	R\$ 60,32 2164001 0.804 2%10	R\$ 73,14 2165101 1.001 2%8
65 ^{RP}						R\$ 42,78 2160701 0.533 2%10	R\$ 49,36 2161801 0.624 2%10	R\$ 54,19 2162801 0.720 2%10	R\$ 65,60 2164101 0.935 2%8	R\$ 82,00 2165201 1.220 1%10
75 ^{RP}						R\$ 54,74 2160801 0.629 2%10	R\$ 58,11 2161901 0.725 2%8	R\$ 61,50 2162901 0.811 1%10	R\$ 76,24 2164201 1.068 1%10	R\$ 96,10 2165301 1.374 1%10
90 ^{RP}								R\$ 70,59 2163001 0.977 1%8	R\$ 88,06 2164301 1.286 1%8	R\$ 108,24 2165401 1.605 1%8
100 ^{RP}								R\$ 78,56 2163101 1.082 1%8	R\$ 98,47 2164401 1.541 1%8	R\$ 126,55 2165501 1.823 1%8

CÓDIGOS, PREÇOS BRUTOS E PESOS POR CENTO - EMBALAGEM MÍNIMA E MASTER.



P2 90x80x50

P3 90x80x60

P4 90x80x80

P5 135x90x80

N1 135x120x90

Consulte lote mínimo

APLICAÇÃO

Utilizado na construção civil, para a fixação de portas e esquadrias em madeira, fixação de dobradiças, rodapés e etc.

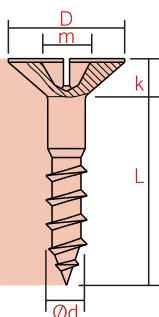

MATERIAL: AÇO BAIXO CARBONO
ACABAMENTO: ZINCADO BRANCO
ROSCA: SOBERBA

Diâmetro	2,5	2,8	3,2	3,5	3,8	4,2	4,5	4,8	5,5	6,1
D (máx.)	5,00	5,60	6,40	7,10	7,70	8,10	9,10	9,70	11,10	12,70
k (máx.)	1,50	1,70	1,90	2,10	2,30	2,50	2,70	2,90	3,30	3,70
m (ref.)	1	1	2	2	2	2	2	2	3	3
passo	1,06	0,91	1,27	1,41	1,59	1,69	1,81	1,95	2,31	2,54
L (mm)										
10	R\$ 5,06 3078001 0.034 5%20	R\$ 5,85 3078601 0.040 5%20								
12	R\$ 5,60 3078101 0.040 5%20	R\$ 6,51 3078701 0.045 5%20	R\$ 6,95 3079401 0.058 5%20	R\$ 8,22 3080101 0.081 5%20	R\$ 10,61 3080901 0.098 5%10					
16	R\$ 5,92 3078201 0.052 5%20	R\$ 7,02 3078801 0.058 5%20	R\$ 7,90 3079501 0.081 5%20	R\$ 9,61 3080201 0.097 5%10	R\$ 10,71 3081001 0.113 5%20	R\$ 13,55 3081801 0.136 5%10	R\$ 16,31 3082801 0.171 5%10	R\$ 19,25 3083901 0.220 5%10		
20	R\$ 6,72 3078301 0.056 5%20	R\$ 7,90 3078901 0.068 5%20	R\$ 8,82 3079601 0.095 5%10	R\$ 10,46 3080501 0.116 5%10	R\$ 12,30 3081301 0.136 5%10	R\$ 13,80 3081901 0.165 5%10	R\$ 16,63 3082901 0.215 5%10	R\$ 19,32 3084201 0.293 5%10	R\$ 28,97 3085101 0.311 5%10	
22	R\$ 7,61 3078401 0.065 5%10	R\$ 8,45 3079001 0.079 5%10	R\$ 9,41 3079701 0.106 5%10	R\$ 11,89 3080401 0.125 5%10	R\$ 14,01 3081201 0.157 5%10	R\$ 15,12 3082001 0.177 5%10	R\$ 17,52 3083001 0.228 5%10	R\$ 19,50 3084101 0.251 5%10	R\$ 30,02 3085201 0.332 5%10	R\$ 38,70 3086201 0.454 2%10
25	R\$ 8,66 3078501 0.069 5%20	R\$ 9,61 3079101 0.089 5%10	R\$ 11,00 3079801 0.124 5%20	R\$ 12,71 3080601 0.145 5%10	R\$ 15,38 3081501 0.165 5%10	R\$ 16,63 3082101 0.195 5%10	R\$ 20,02 3083101 0.262 5%10	R\$ 22,16 3084201 0.348 5%10	R\$ 30,96 3085301 0.366 5%10	R\$ 38,86 3086301 0.487 2%10
30 ^{RP}		R\$ 10,84 3079201 0.112 5%10	R\$ 13,01 3079901 0.145 5%10	R\$ 15,76 3080601 0.183 5%10	R\$ 17,77 2743201 0.208 5%10	R\$ 20,91 2878401 0.260 5%10	R\$ 24,58 3083201 0.323 5%10	R\$ 25,83 3084301 0.348 5%10	R\$ 34,69 3085401 0.452 2%10	R\$ 46,38 3086401 0.595 2%10
40 ^{RP}		R\$ 13,76 3079301 0.142 5%10	R\$ 16,92 3080001 0.202 5%10	R\$ 18,04 3080701 0.235 5%10	R\$ 20,36 3081401 0.278 5%10	R\$ 23,76 3082201 0.331 5%10	R\$ 27,86 3083301 0.403 2%10	R\$ 31,16 3084401 0.468 2%10	R\$ 41,36 3085601 0.579 2%10	R\$ 52,37 3086501 0.775 2%10
45 ^{RP}				R\$ 19,75 3080801 0.278 5%10	R\$ 23,21 3081501 0.316 5%10	R\$ 27,61 3082301 0.368 2%10	R\$ 31,32 3083401 0.443 2%10	R\$ 34,58 3084501 0.520 2%10	R\$ 43,65 3085701 0.664 2%10	R\$ 58,38 3086601 0.849 2%10
50 ^{RP}					R\$ 25,33 3081601 0.348 5%8	R\$ 29,79 3082401 0.409 2%10	R\$ 34,35 3083501 0.487 2%10	R\$ 38,49 3084601 0.549 2%10	R\$ 45,94 41277801 0.703 2%10	R\$ 64,99 3086701 0.932 2%10
55 ^{RP}					R\$ 27,86 3081701 0.372 5%10	R\$ 35,37 3082501 0.455 2%10	R\$ 41,46 3083601 0.536 2%10	R\$ 46,38 3084701 0.620 2%10	R\$ 51,98 3085801 0.765 2%10	R\$ 67,29 3086801 1.020 2%8
65 ^{RP}						R\$ 39,36 3082601 0.532 2%10	R\$ 45,50 3083701 0.629 2%10	R\$ 49,84 3025301 0.723 2%10	R\$ 55,49 2864901 0.939 2%8	R\$ 75,44 3086901 1.196 1%10
75 ^{RP}						R\$ 50,34 3082701 0.603 2%10	R\$ 53,46 3083801 0.706 2%8	R\$ 56,58 41268301 0.812 1%10	R\$ 60,36 3085901 1.051 1%10	R\$ 88,42 3087001 1.389 1%10
90 ^{RP}								R\$ 64,94 3084901 0.993 1%8	R\$ 70,13 3086001 1.292 1%8	R\$ 99,58 3087101 1.608 1%8
100 ^{RP}								R\$ 72,27 3085001 1.093 1%8	R\$ 81,02 3086101 1.422 1%8	R\$ 116,44 3087201 1.822 1%8

CÓDIGOS, PREÇOS BRUTOS E PESOS POR CENTO - EMBALAGEM MÍNIMA E MASTER.



P2 90x80x50

P3 90x80x60

P4 90x80x80

P5 135x90x80

N1 135x120x90

Consulte lote mínimo

APLICAÇÃO



Utilizados na construção civil, para a fixação de portas e esquadrias em madeira, fixação de dobradiças, rodapés e etc.



MATERIAL: AÇO BAIXO CARBONO
ACABAMENTO: ZINCADO BRANCO
ROSCA: SOBERBA

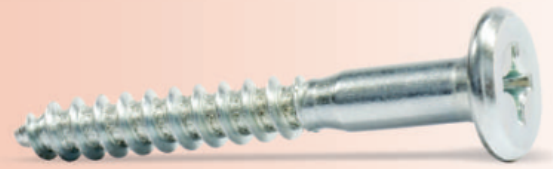
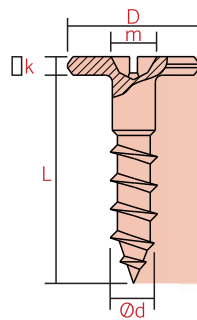

Diâmetro	4,2		4,8		5,5				
D (máx.)	13,20		13,20		13,20				
k (máx.)	2,40		2,40		2,40				
m (ref.)	2		2		3				
passo	1,69		1,95		2,31				
L (mm)									
25			R\$	29,80	3106901 0,431 5%10				
30	R\$	24,87	3095701 0,431 2%10	R\$	34,27	3096001 0,521 5%8			
40	R\$	30,44	3095801 0,497 2%10	R\$	37,86	3096101 0,612 2%10	R\$	44,22	3096801 0,699 2%10
45	R\$	30,93	3095901 0,536 2%10	R\$	40,34	3096201 0,670 2%10	R\$	49,49	3096901 0,762 2%10
50			R\$	44,97	3096301 0,701 2%10	R\$	52,58	3097001 0,849 2%10	
55			R\$	46,39	3096401 0,752 2%10	R\$	55,86	3097101 0,922 2%8	
60			R\$	52,09	3096501 0,821 2%8	R\$	62,47	3097201 0,996 2%8	
65			R\$	57,03	3096601 0,857 2%8	R\$	65,45	3097301 1,048 2%8	
75			R\$	62,84	3096701 0,989 1%10	R\$	74,48	3097401 1,189 1%10	
90						R\$	89,38	3361501 1,340 1%8	
100						R\$	99,99	3361601 1,520 1%10	

CÓDIGOS, PREÇOS BRUTOS E PESOS POR CENTO - EMBALAGEM MÍNIMA E MASTER.



P2 90x80x50

P3 90x80x60

P4 90x80x80

P5 135x90x80

N1 135x120x90

Consulte lote mínimo

APLICAÇÃO

Utilizados na construção civil, para a fixação de portas e esquadrias em madeira, fixação de dobradiças, rodapés e etc.

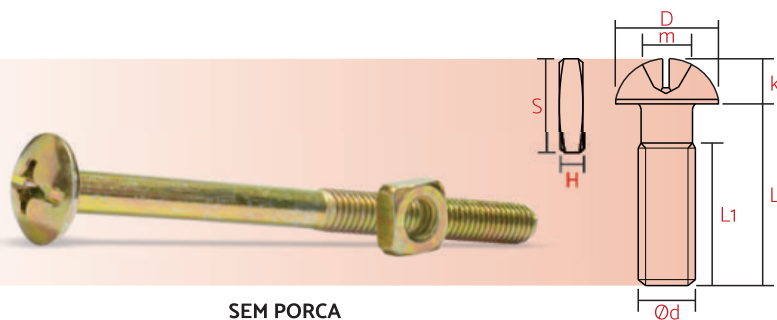

MATERIAL: AÇO BAIXO CARBONO
ACABAMENTO: BICROMATIZADO
ROSCA: MÁQUINA UNC

SEM PORCA

COM PORCA

Diâmetro	1/4"		5/16"	
D (máx.)	14,50		17,70	
k (ref.)	3,80		4,60	
m (ref.)	3		4	
Rosca - Fio	UNC-20		UNC-18	
L1 (min.)	50,00		50,00	
L (mm)				
90	R\$	89,61	3425101 1,980 1%6	
100	R\$	96,98	3068701 2,136 1%4	R\$ 153,00 3007601 3,398 1%4
110	R\$	100,19	3068801 2,199 1%4	R\$ 168,31 3007201 3,686 1%4
120	R\$	113,16	3068901 2,456 1%6	R\$ 184,00 3007301 3,968 1%4

Diâmetro	1/4"		5/16"	
D (máx.)	14,50		17,70	
k (ref.)	3,80		4,60	
m (ref.)	3		4	
Rosca - Fio	UNC-20		UNC-18	
L1 (min.)	50,00		50,00	
S (min.)	11,11		12,70	
H(min.)	4,30		4,80	
L (mm)				
90	R\$	111,13	3257501 2,010 1%6	
100	R\$	117,80	3437901 2,299 1%4	R\$ 180,89 3092101 3,427 1%4
110	R\$	121,71	3091901 2,535 1%4	R\$ 196,21 3092201 3,686 1%4
120	R\$	134,69	3092001 2,731 1%6	R\$ 211,89 3092301 4,028 1%4

PARAFUSO ESTRUTURAL ESCAREADO PHILIPS & ALLEN

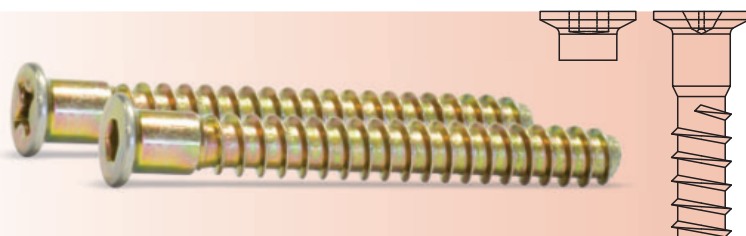

MATERIAL: AÇO BAIXO CARBONO
ACABAMENTO: BICROMATIZADO
ROSCA: ESTRUTURAL

PHILLIPS

ALLEN

Diâmetro	5,0		7,0	
L (mm)				
40	R\$	24,26	3210501 0,410 2%10	R\$ 44,80 3211301 0,790 2%10
50	R\$	29,88	3210601 0,440 2%10	R\$ 55,72 3211401 0,965 2%10
60	R\$	37,54	3210701 0,520 2%10	R\$ 64,48 3211501 1,160 2%6
70			R\$	73,28 3211601 1,344 2%6
80			R\$	82,02 3211701 1,533 2%4

Diâmetro	5,0		7,0	
L (mm)				
40	R\$	24,26	3210201 0,400 2%10	R\$ 43,58 3210801 0,790 2%10
50	R\$	29,88	3210301 0,490 2%10	R\$ 55,77 3210901 0,978 2%10
60	R\$	37,54	3210401 0,590 2%10	R\$ 63,98 3211001 1,155 2%6
70			R\$	72,24 3211101 1,326 2%6
80			R\$	82,02 3211201 1,523 2%4

CÓDIGOS, PREÇOS BRUTOS E PESOS POR CENTO - EMBALAGEM MÍNIMA E MASTER.



P5 135x90x80

N1 135x120x90

Ps2 155x130x135

Ps3 200x130x90

Ps4 230x130x90

MATERIAL: AÇO BAIXO CARBONO
ACABAMENTO: BICROMATIZADO
ROSCA: ESTRUTURAL

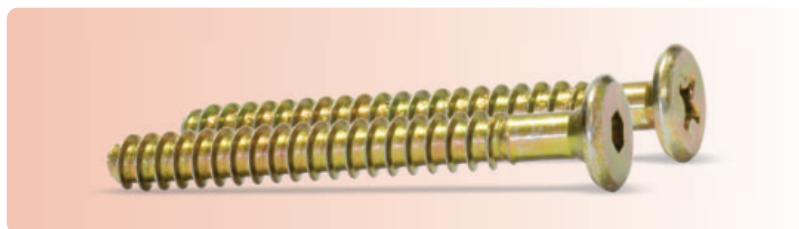

PHILIPS

Diâmetro	7,0		
L (mm)			
40	R\$	47,63	3211801 0,877 2%6
50	R\$	56,73	3211901 1,080 2%6
60	RP R\$	77,14	3212001 1,284 2%6
70	RP R\$	78,32	3212101 1,480 2%6
75	RP R\$	80,48	3212201 1,560 1%6
80	RP R\$	85,07	3212301 1,640 1%6
90	RP R\$	94,08	3212401 1,807 1%6
100	RP R\$	103,41	3212501 1,986 1%6
110	RP R\$	113,79	3212601 2,186 1%4
120	RP R\$	122,39	3212701 2,370 1%4
130	RP R\$	131,61	3212801 2,530 1%4
140	RP R\$	140,94	3212901 2,718 1%4
150	RP R\$	150,32	3213001 2,950 1%4

ALLEN

Diâmetro	7,0		
L (mm)			
40	R\$	47,10	3214301 0,906 2%6
50	R\$	56,73	3214401 1,092 2%6
60	RP R\$	66,31	3214501 1,250 2%6
70	RP R\$	76,93	3214601 1,460 2%6
75	RP R\$	77,14	3214701 1,476 1%6
80	RP R\$	85,07	3214801 1,630 1%6
90	RP R\$	94,08	3214901 1,820 1%6
100	RP R\$	104,25	3215001 2,010 1%6
110	RP R\$	113,79	3215101 2,160 1%4
120	RP R\$	122,39	3215201 2,376 1%4
130	RP R\$	131,61	3215301 2,585 1%4
140	RP R\$	140,21	3215401 2,766 1%4
150	RP R\$	150,17	3215501 2,963 1%4

CÓDIGOS, PREÇOS BRUTOS E PESOS POR CENTO - EMBALAGEM MÍNIMA E MASTER.



Ps2 155x130x135

Ps3 200x130x90

Ps4 230x130x90

APLICAÇÃO

Utilizado em indústria de móveis.

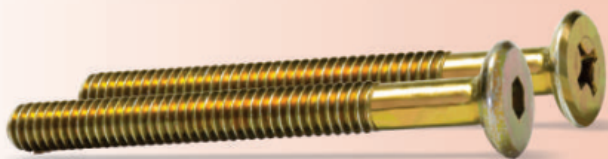

MATERIAL: AÇO SAE 1008/1010
ACABAMENTO: BICROMATIZADO/ZINCADO
ROSCA: MÁQUINA UNC

PHILIPS BICROMATIZADO

Diâmetro	1/4"		
L (mm)			
40	R\$	48,68	3213101 0,909 2%6
50	R\$	58,92	3213201 1,075 2%6
60	RP R\$	63,63	3213301 1,260 2%6
70	RP R\$	76,91	3213401 1,490 1%6
80	RP R\$	80,41	3213501 1,640 1%6
90	RP R\$	88,93	3213601 1,820 1%6
100	RP R\$	97,01	3213701 1,988 1%6
110	RP R\$	108,49	3213801 2,187 1%4
120	RP R\$	115,93	3213901 2,405 1%4
130	RP R\$	124,40	3214001 2,598 1%4
140	RP R\$	132,14	3214101 2,798 1%4
150	RP R\$	141,30	3214201 2,993 1%4

ALLEN BICROMATIZADO

Diâmetro	1/4"		
L (mm)			
40	R\$	44,77	3215601 0,900 2%6
50	R\$	54,02	3215701 1,075 2%6
60	RP R\$	61,63	3215801 1,260 2%6
70	RP R\$	71,19	3215901 1,490 1%6
80	RP R\$	80,21	3216001 1,640 1%6
90	RP R\$	88,82	3216101 1,820 1%6
100	RP R\$	96,02	3216201 1,988 1%6
110	RP R\$	106,62	3216301 2,187 1%4
120	RP R\$	114,75	3216401 2,405 1%4
130	RP R\$	123,81	3216501 2,598 1%4
140	RP R\$	132,58	3216601 2,798 1%4
150	RP R\$	141,30	3216701 2,993 1%4

PHILLIPS ZINCADO

Diâmetro	1/4"		
L (")			
3/4"	R\$	29,76	3075701 0,540 2%20
1"	R\$	34,26	3134301 0,630 2%20
1.1/4"	R\$	39,83	3099301 0,750 2%20
1.1/2"	R\$	46,02	3075801 0,908 2%20
2"	R\$	54,12	3091601 1,074 2%16

CÓDIGOS, PREÇOS BRUTOS E PESOS POR CENTO - EMBALAGEM MÍNIMA E MASTER.



P4 90x80x80

P5 135x90x80

N1 135x120x90

Ps2 155x130x135

Ps3 200x130x90

Ps4 230x130x90

APLICAÇÃO



Normalmente utilizados em indústrias de móveis e outras aplicações diversas.



BROCANTES

UTILIZADOS NA FIXAÇÃO DE ESTRUTURAS METÁLICAS,
UNIÃO DE CHAPAS E PERFIS, FIXAÇÃO DE MADEIRA COM AÇO,
ALUMÍNIO E ETC



DISPONÍVEL NAS OPÇÕES



SEXTAVADO
COM ARRUELA



SEXTAVADO



CHATA
PHILIPS



FLANGEADA
PHILIPS



PANELA
PHILIPS

CHUMBADORES, SOBERBA, FRANCÊS E MAIS!

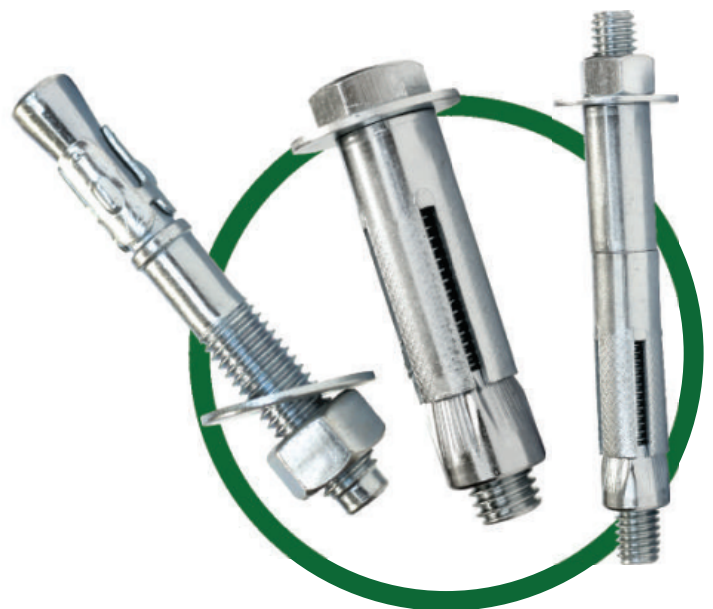
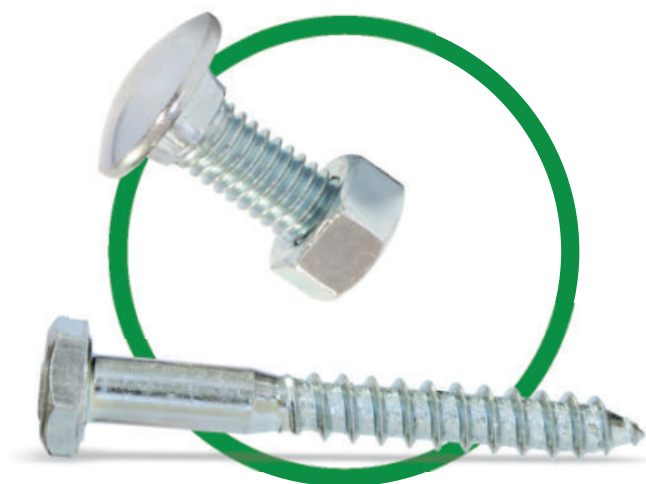

OUTROS ACABAMENTOS

BICROMATIZADO - OXIDADO - NIQUELADO - ZINCADO PRETO - POLIDO

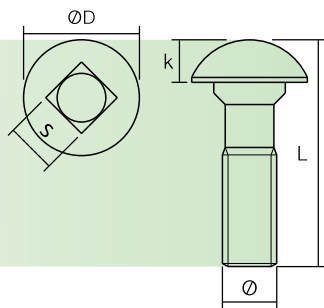

MATERIAL: BAIXO CARBONO
ACABAMENTO: ZINCADO BRANCO
ROSCA: MÁQUINA UNC

Diâmetro	1/4"		5/16"		3/8"		1/2"	
Ød (máx.)	15,09		18,26		21,44			
k (máx.)	3,68		4,47		5,28			
S (máx.)	6,60		8,23		9,85			
L (")								
3/4"	R\$ •	56,54 3113401 0,999 5%4	R\$ •	92,69 3114401 1,663 2%6				
1"	R\$ •	63,61 3113501 1,133 5%4	R\$ •	102,05 3114501 1,861 2%6	R\$ •	150,61 3115401 2,774 2%4		
1.1/4"	R\$ •	68,74 3113601 1,235 2%6	R\$ •	113,23 3114601 2,001 2%6	R\$ •	163,57 3115501 2,920 2%4		
1.1/2"	R\$ •	74,18 3113701 1,351 2%6	R\$ •	118,92 3114701 2,171 2%6	R\$ •	179,17 3115601 3,326 1%6		
1.3/4"	R\$ •	80,94 3116201 1,483 2%6	R\$ •	131,47 3114801 2,423 2%4	R\$ •	193,05 3115701 3,502 1%6		
2"	R\$ •	85,56 3113801 1,589 2%6	R\$ •	139,10 3114901 2,577 2%4	R\$ •	206,92 3115801 3,858 1%6		
2.1/4"	R\$ •	93,39 3113901 1,715 2%4	R\$ •	146,47 3115001 2,749 2%4	R\$ •	220,08 3115901 4,148 1%4		
2.1/2"	R\$ •	97,51 3114001 1,741 2%4	R\$ •	158,71 3115101 2,933 2%4	R\$ •	233,25 3116001 4,412 1%4		
2.3/4"	R\$ •	101,78 3114101 1,943 2%4	R\$ •	164,81 3115201 3,119 1%4	R\$ •	247,02 3114201 4,844 1%4		
3"	R\$ •	108,23 3114301 2,073 2%4	R\$ •	177,37 3115301 3,393 1%4	R\$ •	260,85 3116101 4,974 1%4		
3.1/2"	R\$ •	121,45 3301401 2,300 1%4						

Até 8"
CONSULTE

CÓDIGOS, PREÇOS BRUTOS E PESOS POR CENTO - EMBALAGEM MÍNIMA E MASTER.



P4 90x80x80

P5 135x90x80

Ps2 155x130x135

Ps3 200x130x90

Ps4 230x130x90

APLICAÇÃO

Utilizados em carrocerias de caminhões, cercas de madeira, placas de sinalização, vigamento de casas e etc.

MATERIAL: BAIXO CARBONO
ACABAMENTO: ZINCADO BRANCO
ROSCA: SOBERBA

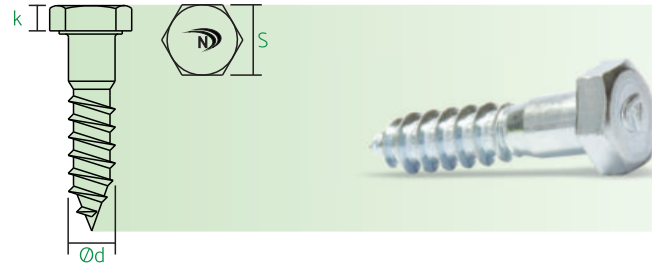

Diâmetro	3/16"		1/4"		5/16"		3/8"					
S (máx.)	7,92		11,10		12,70		14,30					
k (máx.)	2,90		4,05		5,15		5,94					
S (máx.)	7,92		11,10		12,70		14,30					
L (mm)												
25	R\$	15,98	3040501 0,310 5%10									
30	R\$	18,40	3040601 0,386 5%10	R\$	37,70	3041401 0,786 2%10	R\$	62,99	3043001 1,228 2%10			
35	R\$	20,74	2879801 0,440 2%10	R\$	40,46	3041501 0,868 2%10	R\$	69,36	3043101 1,372 2%10			
40	R\$	23,08	2939401 0,488 2%10	R\$	44,80	3038001 0,948 2%10	R\$	75,78	2852401 1,530 2%6	R\$	113,39	3044701 2,162 1%10
45	R\$	25,42	3040701 0,542 2%10	R\$	49,17	3041601 1,024 2%10	R\$	80,07	3043201 1,674 2%6	R\$	115,86	2879701 2,355 1%6
50	R\$	27,97	3040801 0,600 5%6	R\$	54,02	3041701 1,096 2%6	R\$	84,58	3043301 1,834 2%6	R\$	127,76	2810901 2,548 1%6
55	R\$	30,13	3037801 0,634 2%10	R\$	55,80	3041801 1,198 2%6	R\$	94,95	3043401 1,956 2%6	R\$	134,98	3044801 2,800 1%6
60	R\$	32,30	3040901 0,698 2%6	R\$	61,50	3041901 1,280 2%6	R\$	101,66	3043501 2,066 1%6	R\$	142,21	3044901 2,918 1%6
65	R\$	33,96	3041001 0,748 2%6	R\$	64,30	3042001 1,376 2%6	R\$	109,35	3043601 2,236 1%6	R\$	152,24	3045001 3,140 1%6
70	R\$	36,42	3037901 0,794 2%6	R\$	68,34	3042101 1,454 1%6	R\$	113,48	3043701 2,438 1%6	R\$	159,64	3045101 3,344 1%6
75	R\$	38,85	3041101 0,856 2%6	R\$	71,53	3042201 1,532 1%6	R\$	119,21	3043801 2,468 1%6	R\$	167,03	3045201 3,578 0,5%6
80			R\$	76,63	3042301 1,648 1%6	R\$	122,27	3043901 2,662 1%6	R\$	176,04	3045301 3,810 0,5%6	
90			R\$	83,60	3042401 1,796 1%6	R\$	134,17	3044101 2,942 0,5%6	R\$	190,78	3045401 4,164 0,5%6	
100			R\$	92,52	3041301 2,006 1%6	R\$	147,35	3042501 3,250 0,5%6	R\$	211,82	3044201 4,572 0,5%6	

PARAFUSO TELHA-FIX COM & SEM CONJUNTO DE VEDAÇÃO

MATERIAL: BAIXO CARBONO
ACABAMENTO: ZINCADO BRANCO
ROSCA: SOBERBA



COM CONJUNTO DE VEDAÇÃO

Diâmetro	5/16"		
L (mm)			
110	R\$	131,22	3436701 0,270 1%

SEM CONJUNTO DE VEDAÇÃO

Diâmetro	5/16"		
L (mm)			
110	R\$	107,22	3416801 0,237 1%

CÓDIGOS, PREÇOS BRUTOS E PESOS POR CENTO - EMBALAGEM MÍNIMA E MASTER.



ACABAMENTO: ZINCADO BRANCO
ROSCA: MÁQUINA UNC

Diâmetro	1/4"	5/16	3/8"	1/2"	5/8"	3/4"
L (")						
2"	R\$ 4,20 24716401 0,024 1%					
2.1/4"		R\$ 6,80 24721501 0,044 1%				
2.1/2"			R\$ 8,20 24726601 0,062 0,5%			
3"	R\$ 6,80 24716801 0,034 1%			R\$ 24,80 24736801 0,145 0,25%		
3.1/4"		R\$ 14,40 24721901 0,063 0,5%				
3.1/2"			R\$ 8,90 24727001 0,089 0,5%		R\$ 46,00 24747001 0,254 0,2%	
4.1/2"				R\$ 37,00 24737301 0,210 0,25%		R\$ 92,00 2804701 0,342 0,15%
5"					R\$ 52,00 24747601 0,360 0,1%	

CHUMBADOR COM PRISIONEIRO



ACABAMENTO: ZINCADO BRANCO
ROSCA: MÁQUINA UNC

Diâmetro	1/4"	5/16	3/8"	1/2"	5/8"
L (mm)					
65	R\$ 5,00 24816701 0,027 1%				
75		R\$ 8,80 24821901 0,047 1%			
80			R\$ 11,00 24827001 0,072 0,5%		
90	R\$ 7,20 24817201 0,035 1%				
95				R\$ 28,30 24837301 0,150 0,25%	
100		R\$ 11,10 24822401 0,057 0,5%			
110			R\$ 15,80 24827601 0,095 0,5%		
115					R\$ 50,00 24847701 0,264 0,2%
135				R\$ 38,00 24838101 0,206 0,25%	

CÓDIGOS, PREÇOS BRUTOS E PESOS POR PEÇA - EMBALAGEM MÍNIMA E MASTER.

ACABAMENTO: ZINCADO BRANCO
ROSCA: MÁQUINA UNC

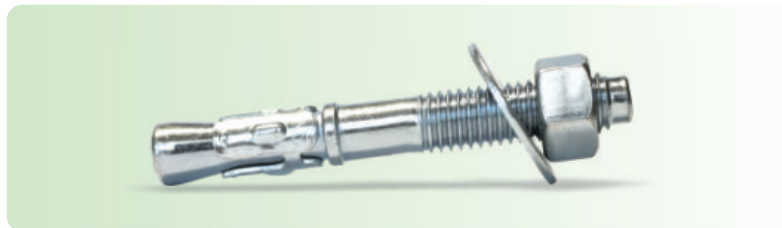

Diâmetro	1/4"	5/16	3/8"	1/2"	5/8"	3/4"	7/8"
L (")							
2"		R\$ 4,60 2242301 0.023 1%					
2.1/4"	R\$ 3,50 2242101 0.017 1%		R\$ 6,30 2798101 0.040 1%				
2.3/4"	3,50		R\$ 6,70 2242501 0.045 1%	R\$ 11,20 2801801 0.086 0.5%			
3"			R\$ 6,90 964101 0.047 1%				
3.1/4"	R\$ 4,30 2242201 0.021 1%	R\$ 5,60 2242401 0.033 1%					
3.1/2"			R\$ 7,80 2242601 0.054 0.5%				
3.3/4"			R\$ 7,90 2804001 0.057 0.5%	R\$ 13,70 2801901 0.106 0.5%			
4"				R\$ 14,30 964201 0.111 0.5%			
4.1/4"		R\$ 6,50 2804301 0.042 0.5%		R\$ 15,30 3181701 0.0132 0.25%		R\$ 38,00 2838301 0.269 0.1%	
4.1/2"					R\$ 25,50 2802001 0.197 0.2%		
4.3/4"						R\$ 44,60 2804501 0.269 0.1%	
5"			R\$ 10,10 2804101 0.072 0.5%		R\$ 27,20 2802101 0.200 0.2%		
5.1/2"				R\$ 18,20 2834801 0.153 0.25%		R\$ 44,90 2838401 0.292 0.1%	
6"					R\$ 30,80 2802201 0.228 0.1%		
6.1/4"						R\$ 49,70 2804601 0.370 0.1%	
7"				R\$ 22,90 3150401 0.157 0.25%	R\$ 35,40 2858401 0.274 0.1%		
8"					R\$ 43,90 3263901 0.294 0.1%		R\$ 95,00 2863601 0.600 0.2%

JAQUETA & CONE

ACABAMENTO: ZINCADO BRANCO
ROSCA: MÁQUINA UNC



Diâmetro	1/4"	5/16	3/8"	1/2"	5/8"	3/4"
L (mm)						
65	R\$ 2,74 2233201 0.083 5%	R\$ 3,95 2233301 0.141 2%	R\$ 4,26 2233401 0.182 2.5%	R\$ 9,12 2233501 0.463 1%	R\$ 18,24 2233601 0.820 1%	R\$ 37,49 2233701 1.167 1%

CÓDIGOS, PREÇOS BRUTOS E PESOS POR PEÇA - EMBALAGEM MÍNIMA E MASTER.



ACABAMENTO: ZINCADO BRANCO
ROSCA: MÁQUINA UNC

Diâmetro	1/4"	5/16	3/8"	1/2"	3/4"
L (mm)					
65	R\$ 1,49 <small>2848601</small>	R\$ 2,24 <small>2848701</small>	R\$ 2,45 <small>3217901</small>	R\$ 6,83 <small>3244301</small>	R\$ 25,60 <small>3225401</small>

SOQUETE IMANTADO SEXTAVADO



ACABAMENTO: ZINCADO BRANCO

Diâmetro	1/4"	5/16	3/8"	7/16"
L (mm)				
65	R\$ 35,40 <small>3126801</small> <small>0.10%</small>	R\$ 35,40 <small>3174501</small> <small>0.10%</small>	R\$ 35,40 <small>3251801</small> <small>0.10%</small>	R\$ 35,40 <small>3400201</small> <small>0.10%</small>

PONTEIRA PHILIPS



ACABAMENTO: ZINCADO BRANCO

Diâmetro	N.1	N.2	N.3
L (mm)			
25	R\$ 14,32 <small>967</small> <small>0.20%</small>	R\$ 14,32 <small>968</small> <small>0.10%</small>	R\$ 14,32 <small>970</small> <small>0.10%</small>
50	R\$ 24,12 <small>972</small> <small>0.20%</small>	R\$ 24,12 <small>956</small> <small>0.10%</small>	R\$ 24,12 <small>962</small> <small>0.10%</small>

CÓDIGOS, PREÇOS BRUTOS E PESOS POR UNIDADE - EMBALAGEM MÍNIMA

MATERIAL: PLÁSTICO/NYLON



Código	Descrição	Embalagem	Preço
5767	Bucha Fix Plast 05	1000	R\$ 57,70
5115	Bucha Fix Plast 06	1000	R\$ 61,30
8014	Bucha Fix Plast 07	1000	R\$ 73,00
5116	Bucha Fix Plast 08	1000	R\$ 95,80
5117	Bucha Fix Plast 10	500	R\$ 103,70
6106	Bucha Fix Plast 12	250	R\$ 77,90
3071501	Bucha Fix Plast c/ anel 06	1000	R\$ 86,30
3120401	Bucha Fix Plast c/ anel 08	1000	R\$ 126,20
3071601	Bucha Fix Plast c/ anel 10	500	R\$ 133,60
3124301	Bucha Fix Nylon 05	500	R\$ 81,20
3077201	Bucha Fix Nylon 06	500	R\$ 86,30
3077301	Bucha Fix Nylon 08	500	R\$ 169,30
3077401	Bucha Fix Nylon 10	250	R\$ 169,30
3077501	Bucha Fix Nylon 12	250	R\$ 270,90
3120501	Bucha Fix p/ tijolo 06	200	R\$ 45,90
3150801	Bucha Fix p/ tijolo 08	100	R\$ 49,10
3185001	Bucha Fix p/ tijolo 10	50	R\$ 40,70

CÓDIGOS, PREÇOS BRUTOS E PESOS POR EMBALAGEM

APLICAÇÃO

Utilizado em conjunto com parafuso na fixação de produtos em paredes de alvenaria, concreto, etc.

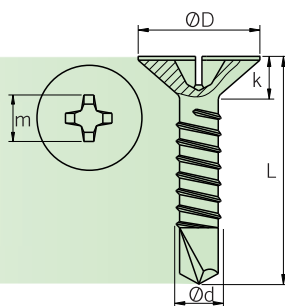

MATERIAL: AÇO SAE 1022
TRATAMENTO: TEMPERADO
ACABAMENTO: ZINCADO BRANCO
PONTA: BROCA PERFORANTE
ROSCA: TIPO C

Diâmetro	#06(3,5)	#07(3,9)	#08(4,2)	#10(4,8)
L (mm)				
13	R\$ 16,92 3221501 0,070 10%5	R\$ 19,13 3221901 0,078 5%10	R\$ 18,20 3222601 0,100 5%10	
16	R\$ 17,50 3221601 0,086 5%10	R\$ 20,66 3222001 0,102 5%10	R\$ 21,95 3222701 0,115 5%10	
19	R\$ 19,96 3221701 0,097 5%10	R\$ 23,21 3222101 0,119 5%10	R\$ 24,98 3222801 0,135 5%10	R\$ 32,56 3223301 0,190 5%10
22			R\$ 29,63 3222901 0,161 5%10	
25	R\$ 24,50 3221801 0,123 5%10	R\$ 27,89 3222201 0,159 5%10	R\$ 31,75 3223001 0,246 5%10	R\$ 41,42 3223401 0,233 5%10
32		R\$ 35,59 3222301 0,183 5%10	R\$ 36,64 3223101 0,254 5%10	R\$ 49,82 3223501 0,291 5%10
38		R\$ 40,95 3222401 0,250 5%10	R\$ 39,56 3223201 0,270 5%10	R\$ 58,11 3223601 0,471 2%10
45		R\$ 47,73 3222501 0,360 2%20		
50				R\$ 79,24 3223701 0,488 2%10

CÓDIGOS, PREÇOS BRUTOS E PESOS POR CENTO - EMBALAGEM MÍNIMA E MASTER.



P2 90x80x50

P3 90x80x60

P4 90x80x80

P5 135x90x80

N1 135x120x90

APLICAÇÃO

Utilizado na fixação de estruturas metálicas, união de chapas e perfis, fixação de madeiras com aço ou alumínio.

MATERIAL: AÇO SAE 1022
TRATAMENTO: TEMPERADO
ACABAMENTO: ZINCADO BRANCO
PONTA: BROCA PERFURANTE
ROSCA: TIPO C

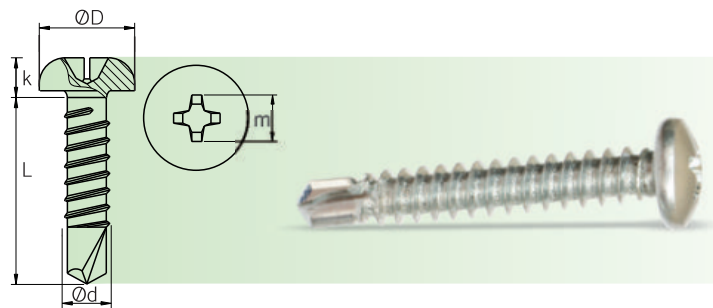

Diâmetro	#04(2,9)	#06(3,5)	#07(3,9)	#08(4,2)	#10(4,8)
L (mm)					
9,5	R\$ 15,01 3218401 0,053 5%10	R\$ 16,28 3219001 0,079 5%10			
11		R\$ 17,50 3219101 0,080 5%10			
13	R\$ 15,75 3218501 0,064 5%10	R\$ 17,55 3219201 0,100 5%20	R\$ 19,72 3219601 0,117 5%10	R\$ 21,60 3220001 0,129 5%10	
16	R\$ 18,09 3218601 0,073 5%10	R\$ 19,37 3219301 0,117 5%10	R\$ 22,87 3219701 0,138 5%10	R\$ 26,25 3220101 0,146 5%10	R\$ 32,67 3220801 0,206 5%10
19	R\$ 19,48 3218701 0,081 5%10	R\$ 20,77 3219401 0,138 5%10	R\$ 25,68 3219801 0,167 5%10	R\$ 29,76 3220201 0,163 5%10	R\$ 36,18 3220901 0,242 5%10
25	R\$ 24,85 3218801 0,098 5%10	R\$ 26,25 3219501 0,165 5%10	R\$ 43,36 3219901 0,193 5%10	R\$ 36,18 3220301 0,202 5%10	R\$ 47,84 3221001 0,397 5%10
32	R\$ 30,92 3218901 0,122 5%10			R\$ 44,10 3220401 0,242 5%10	R\$ 65,54 3221101 0,461 5%10
38				R\$ 48,90 3220501 0,312 5%10	R\$ 69,78 3221201 0,528 5%10
45				R\$ 51,35 3220601 0,379 2%10	R\$ 73,58 3221301 0,596 2%10
50				R\$ 59,16 3220701 0,420 2%10	R\$ 84,37 3221401 0,654 2%10

CÓDIGOS, PREÇOS BRUTOS E PESOS POR CENTO - EMBALAGEM MÍNIMA E MASTER.



P2 90x80x50

P3 90x80x60

P4 90x80x80

P5 135x90x80

N1 135x120x90

APLICAÇÃO

Utilizado na fixação de estruturas metálicas, união de chapas e perfis, fixação de madeiras com aço ou alumínio.

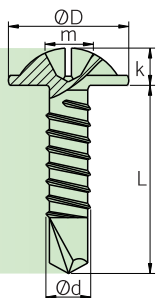

MATERIAL: AÇO SAE 1022
TRATAMENTO: TEMPERADO
ACABAMENTO: ZINCADO BRANCO
PONTA: BROCA PERFURANTE
ROSCA: TIPO C

Diâmetro		#8(4,2)	
L (mm)	L (")	R\$	
13	1/2"	21,60	2100201 0,134 5%10
16	5/8"	25,55	2100301 0,151 5%10
19	3/4"	27,89	2100401 0,163 5%10
25	1"	33,61	2100501 0,200 5%10
32	1.1/4"	40,26	2100601 0,251 2%10
38	1.1/2"	44,93	2100701 0,268 2%10
50	2"	58,23	2100801 0,401 2%10
63	2.1/2"	70,14	2100901 0,442 2%10
75	3"	78,93	2101001 0,620 2%10

ARRUELA NEOPRENE



VEDAÇÃO: EPDM

12 (#10)		14(#12)		16(#14)	
R\$	21,01	R\$	21,01	R\$	22,17
	3123001 5%		2094801 5%		2094901 5%

CÓDIGOS, PREÇOS BRUTOS E PESOS POR CENTO- EMBALAGEM MÍNIMA E MASTER.



P2 90x80x50

P3 90x80x60

P4 90x80x80

P5 135x90x80

N1 135x120x90

APLICAÇÃO

Utilizado na fixação de estruturas metálicas, união de chapas e perfis, fixação de madeiras com aço ou alumínio.

MATERIAL: AÇO SAE 1022
TRATAMENTO: TEMPERADO
ACABAMENTO: ZINCADO BRANCO
PONTA: BROCA PERFURANTE
ROSCA: TIPO C

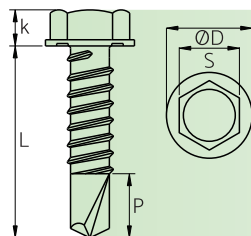

COM ARRUELA

Diâmetro	#08(4,2)	#10(4,8)	#12(5,5)	#14(6,3)
Chave	1/4"	5/16"	5/16"	3/8"
L (mm)				
1/2"		R\$ 85,29 2095301 0,315 2%10		
5/8"	R\$ 87,29 2095101 0,237 2%10	R\$ 87,71 2095401 0,343 2%10		
3/4"	R\$ 91,43 2095201 0,256 2%10	R\$ 57,18 2095501 0,360 2%10	R\$ 68,85 2095801 0,390 2%10	R\$ 92,77 2096701 0,616 2%10
7/8"		R\$ 114,71 2799301 0,398 2%10	R\$ 74,22* 2095901 0,431 2%10	R\$ 101,40* 2096801 0,667 2%10
1"		R\$ 108,43 2095601 0,420 2%10	R\$ 78,42 2096001 0,466 2%10	R\$ 110,74 2096901 0,686 2%10
1.1/2"		R\$ 135,71 2095701 0,532 2%8	R\$ 99,19 2096101 0,615 2%10	R\$ 141,19 2097001 0,871 2%8
2"			R\$ 118,44 2096201 0,726 1%10	R\$ 174,45 2097101 1,070 1%10
2.1/2"			R\$ 141,78 2096301 0,858 1%10	R\$ 200,95 2097201 1,145 1%8
3"			R\$ 155,20 2096401 1,032 1%8	R\$ 237,05 2097301 1,417 1%8
3.1/2"			R\$ 170,96 2096501 1,171 1%8	R\$ 356,86 2097401 1,480 1%8
4"			R\$ 202,00 2096601 1,303 1%8	R\$ 399,71 2730201 1,779 0,5%8

SEM ARRUELA

Diâmetro	#08(4,2)	#10(4,8)	#12(5,5)	#14(6,3)
Chave	1/4"	5/16"	5/16"	3/8"
L (mm)				
1/2"	R\$ 22,75 2097501 0,142 2%10	R\$ 38,43 2097801 0,207 2%10		
5/8"	R\$ 26,14 2097601 0,158 2%10	R\$ 36,77 2097901 0,228 5%10		
3/4"	R\$ 31,29 2097701 0,161 2%10	R\$ 39,56 2098001 0,255 2%10	R\$ 53,68 2098501 0,336 5%10	R\$ 81,86 2098801 0,499 2%10
7/8"		R\$ 49,14 2098101 0,380 2%10		R\$ 88,43* 2799201 0,513 2%10
1"			R\$ 67,66 2098601 0,413 2%10	R\$ 89,27 2243001 0,679 2%8
1.1/2"			R\$ 90,57 2098901 0,566 2%10	
2"			R\$ 101,43 2098701 0,688 1%10	

CÓDIGOS, PREÇOS BRUTOS E PESOS POR CENTO - EMBALAGEM MÍNIMA E MASTER.
* MEDIDA PRÓPRIA PARA A FIXAÇÃO E UNIÃO DOS ENCONTROS DE TELHAS (COSTURA)



P2 90x80x50

P3 90x80x60

P4 90x80x80

P5 135x90x80

N1 135x120x90

APLICAÇÃO

Utilizado na fixação de estruturas metálicas, união de chapas e perfis, fixação de madeiras com aço ou alumínio.

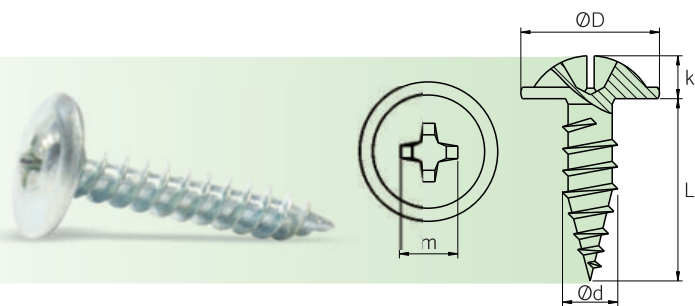

MATERIAL: AÇO SAE 1022
TRATAMENTO: TEMPERADO
ACABAMENTO: ZINCADO BRANCO
PONTA: AGULHA
ROSCA: PERFURANTE - DUAS ENTRADAS

Diâmetro		4,2	
D (máx.)		10,60	
k (máx.)		2,70	
m (ref.)		4,70	
L (mm)			
13	R\$	18,67	2155801 0,135 5%10
16	R\$	21,60	3031601 0,164 5%10
19	R\$	23,11	2846501 0,170 5%10
25	R\$	28,36	3031701 0,214 5%10

PARAFUSO TROMBETA PHILIPS PONTA AGULHA



MATERIAL: AÇO SAE 1022
TRATAMENTO: TEMPERADO
ACABAMENTO: FOSFATIZADO
PONTA: AGULHA
ROSCA: PERFURANTE - DUAS ENTRADAS

Diâmetro		3,5	
D (máx.)		8,15	
k (máx.)		4,65	
m (ref.)		4,70	
L (mm)			
25	R\$	16,92	2155101 0,122 5%10
35	R\$	24,39	2155301 0,156 5%10
45	R\$	30,34	2155501 0,207 5%8
55	R\$	37,22	2155701 0,240 5%8

CÓDIGOS, PREÇOS BRUTOS E PESOS POR CENTO - EMBALAGEM MÍNIMA E MASTER.

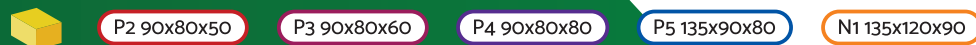

APLICAÇÃO

Utilizado na fixação de placas de gesso, em montagens de paredes drywall e etc

REBITES

UTILIZADO EM TODA INDÚSTRIA, PRINCIPALMENTE EM MONTAGENS E FIXAÇÃO DE PEÇAS ONDE SE TEM ACESSO POR APENAS UM LADO. AGILIZA A PRODUÇÃO E PROPORCIONA GRANDE RESISTÊNCIA (KGF) TAMBÉM CONHECIDO COMO REBITE CEGO.

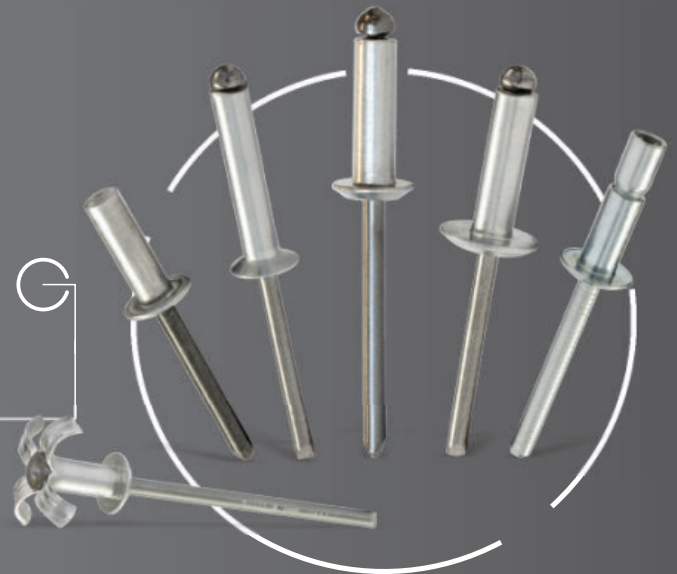

DISPONÍVEL NAS OPÇÕES



NATURAL



CORES



ABA LARGA



ABA ESCAREADA



FLORADO



HERMÉTICO



AÇO CARBONO



INOX



NEW-BOLT



NEW-LOCK

REPUXO, MACIÇO, SEMI TUBULAR

E ESPECIAIS CONFORME DESENHO.

REBITADORES

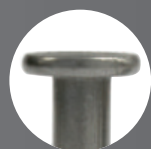

CHATA

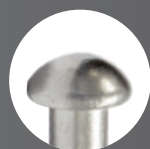

REDONDA



LENTILHA

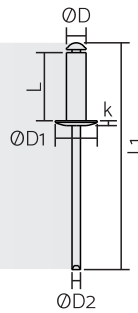

MATERIAL DO ILHÓS: ALUMÍNIO
MATERIAL DO PREGO: AÇO CARBONO
ACABAMENTO: POLIDO BRILHANTE

Diâmetro ▶		3/32" (2,4)	1/8" (3,2)	5/32" (4,0)	3/16" (4,8)	1/4" (6,2)					
ØD1 (min.)		5,00	6,30	7,70	9,30	11,90					
k (min.)		1,00	1,30	1,50	1,80	2,00					
ØD2 (min.)		1,40	1,80	2,20	2,60	3,17					
L1 (máx.)		40,00	52,00	55,00	72,00	75,00					
L (mm)	L (")	LINHA 200		LINHA 300		LINHA 400		LINHA 500		LINHA 600	
6	1/4"	R\$ 175,79	2009801 0,580 1M8	R\$ 136,50	2010201 0,980 1M8	R\$ 192,94	2011201 1,480 1M8	R\$ 297,89	2012301 2,380 1M8		
8	5/16"	R\$ 183,36	2009901 0,600 1M8	R\$ 138,42	2010301 1,010 1M8	R\$ 203,78	2011301 1,600 1M8	R\$ 308,64	2012401 2,420 1M8	R\$ 511,02	2013601 3,960 0,5M4
10	3/8"	R\$ 186,15	2010001 0,620 1M8	R\$ 150,33	2010401 1,060 1M8	R\$ 220,25	2011401 1,680 1M8	R\$ 323,03	2012501 2,460 1M8	R\$ 514,32	2013701 4,120 0,5M4
12	1/2"	R\$ 193,01	2010101 0,640 1M8	R\$ 157,22	2010501 1,080 1M8	R\$ 231,70	2011501 1,740 1M8	R\$ 330,60	2012601 2,540 1M8	R\$ 543,25	2013801 4,260 0,5M4
14	9/16"			R\$ 163,96	2010601 1,260 1M8	R\$ 263,72	2011601 1,880 1M8	R\$ 346,38	2012701 2,560 1M8	R\$ 598,93	2013901 4,400 0,5M4
16	5/8"			R\$ 165,17	2010801 1,300 1M8	R\$ 266,18	2011801 1,980 1M8	R\$ 361,23	2012801 2,880 1M8	R\$ 600,75	2014101 4,800 0,5M4
19	3/4"			R\$ 179,79	2010901 1,320 1M8	R\$ 285,51	2011901 2,000 1M8	R\$ 409,72	2013001 2,980 1M8	R\$ 660,26	2014201 4,960 0,5M4
22	7/8"			R\$ 232,56	2011001 1,440 1M8	R\$ 346,71	2012001 2,180 1M8	R\$ 457,19	2013101 3,240 1M8	R\$ 728,16	2014301 5,700 0,5M4
25	1"			R\$ 241,73	2011101 1,480 1M8	R\$ 364,29	2012101 2,360 1M8	R\$ 478,24	2013201 3,380 1M8	R\$ 770,59	2014401 5,750 0,5M4
30	1.3/16"							R\$ 592,85	2013301 3,780 0,5M4	R\$ 1009,13	2014501 6,460 0,5M4
35	1.3/8"							R\$ 770,44	2013401 4,320 0,5M4	R\$ 1150,92	2014601 7,164 0,25M2
40	1.1/2"							R\$ 814,09	2013501 4,480 0,5M4	R\$ 1224,28	2014701 7,620 0,25M2

CÓDIGOS, PREÇOS BRUTOS E PESOS POR MILHEIRO - EMBALAGEM MÍNIMA E MASTER.



N1 135x120x90

N2 135x120x135

N3 180x120x140

APLICAÇÃO



Utilizado em toda indústria, principalmente em montagens e fixações onde se tem acesso apenas por um lado. Agiliza a produção e proporciona grande resistência (KGF).



MATERIAL DO ILHÓS: ALUMÍNIO
MATERIAL DO PREGO: AÇO CARBONO
ACABAMENTO: POLIDO BRILHANTE



Diâmetro ▶		3/32" (2,4)	1/8" (3,2)	5/32" (4,0)	3/16" (4,8)	1/4" (6,2)					
ØD1 (min.)		5,00	6,30	7,70	9,30	11,90					
k (min.)		1,00	1,30	1,50	1,80	2,00					
ØD2 (min.)		1,40	1,80	2,20	2,60	3,17					
L1 (máx.)		40,00	52,00	55,00	72,00	75,00					
L (mm)	L (")	LINHA 200		LINHA 300		LINHA 400		LINHA 500		LINHA 600	
6	1/4"	R\$ 38,58	2039101 0,116 2%20	R\$ 29,99	2039401 0,196 2%20	R\$ 42,53	2040401 0,296 2%20	R\$ 65,51	2041401 0,476 2%20		
8	5/16"	R\$ 40,38	2039201 0,120 2%20	R\$ 30,48	2039501 0,202 2%20	R\$ 44,87	2040501 0,320 2%20	R\$ 67,97	2041501 0,492 2%20		
10	3/8"	R\$ 41,07	2039301 0,124 2%20	R\$ 33,03	2039601 0,212 2%20	R\$ 48,49	2040601 0,320 2%20	R\$ 71,06	2041601 0,484 2%20	R\$ 56,57	2042601 0,412 1%20
12	1/2"	R\$ 42,46	2800601 0,128 2%20	R\$ 34,58	2039701 0,216 2%20	R\$ 50,97	2040701 0,348 2%20	R\$ 72,71	2041701 0,512 2%20	R\$ 59,86	2042701 0,426 1%20
14	9/16"			R\$ 36,05	2039801 0,252 2%20	R\$ 58,01	2040801 0,376 2%20	R\$ 76,25	2041801 0,508 2%20	R\$ 65,92	2042801 0,440 1%20
16	5/8"			R\$ 36,28	2040001 0,252 2%20	R\$ 58,55	2041001 0,396 2%20	R\$ 79,42	2041901 0,576 2%20	R\$ 66,27	2043001 0,480 1%20
19	3/4"			R\$ 39,52	2040101 0,264 2%20	R\$ 62,80	2041101 0,400 2%20	R\$ 90,09	2042001 0,596 2%20	R\$ 72,68	2043101 0,496 1%20
22	7/8"			R\$ 51,20	2040201 0,296 2%20	R\$ 76,30	2041201 0,436 2%20	R\$ 100,62	2042101 0,648 2%10	R\$ 80,03	2043201 0,570 1%20
25	1"			R\$ 53,17	2040301 0,288 2%20	R\$ 80,28	2041301 0,472 2%20	R\$ 105,26	2042201 0,676 2%10	R\$ 84,71	2043301 0,575 1%20
30	1.3/16"							R\$ 65,18	2042301 0,378 1%20	R\$ 111,04	2043401 0,646 1%10
35	1.3/8"							R\$ 84,71	2042401 0,432 1%10	R\$ 63,31	2043501 0,358 0,5%20
40	1.1/2"							R\$ 89,48	2042501 0,448 1%20	R\$ 67,31	2043601 0,381 0,5%20

CÓDIGOS, PREÇOS BRUTOS E PESOS POR CAIXA - EMBALAGEM MÍNIMA E MASTER.



P4 90x80x80

P5 135x90x80

APLICAÇÃO

Utilizado em toda indústria, principalmente em montagens e fixações onde se tem acesso apenas por um lado. Agiliza a produção e proporciona grande resistência (KGF).

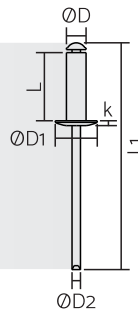

MATERIAL DO ILHÓS: ALUMÍNIO
MATERIAL DO PREGO: AÇO CARBONO
ACABAMENTO: PINTADO EPOXI

Diâmetro ▶		3/32" (2,4)	1/8" (3,2)	5/32" (4,0)	3/16" (4,8)	1/4" (6,2)					
ØD1 (min.)		5,00	6,30	7,70	9,30	11,90					
k (min.)		1,00	1,30	1,50	1,80	2,00					
ØD2 (min.)		1,40	1,80	2,20	2,60	3,17					
L1 (máx.)		40,00	52,00	55,00	72,00	75,00					
L (mm)	L (")	LINHA 200		LINHA 300		LINHA 400		LINHA 500		LINHA 600	
6	1/4"	R\$ 246,10	0,580 IMB	R\$ 191,09	0,980 IMB	R\$ 270,11	1,480 IMB	R\$ 417,05	2,380 IMB		
8	5/16"	R\$ 256,71	0,600 IMB	R\$ 193,79	1,010 IMB	R\$ 285,29	1,520 IMB	R\$ 432,09	2,420 IMB	R\$ 715,43	3,960 0,5M8
10	3/8"	R\$ 260,61	0,620 IMB	R\$ 210,46	1,060 IMB	R\$ 308,35	1,600 IMB	R\$ 452,24	2,460 IMB	R\$ 720,04	4,120 0,5M8
12	1/2"	R\$ 270,22	0,640 IMB	R\$ 220,11	1,080 IMB	R\$ 324,38	1,740 IMB	R\$ 462,84	2,540 IMB	R\$ 760,55	4,260 0,5M8
14	9/16"			R\$ 229,54	1,140 IMB	R\$ 369,21	1,880 IMB	R\$ 484,94	2,560 IMB	R\$ 838,50	4,400 0,5M8
16	5/8"			R\$ 231,24	1,260 IMB	R\$ 372,65	1,980 IMB	R\$ 505,72	2,880 IMB	R\$ 841,06	4,800 0,5M8
19	3/4"			R\$ 251,71	1,320 IMB	R\$ 399,71	2,000 IMB	R\$ 573,60	2,980 IMB	R\$ 924,37	4,960 0,5M8
22	7/8"			R\$ 325,58	1,480 IMB	R\$ 485,40	2,180 IMB	R\$ 640,07	3,240 IMB	R\$ 1019,42	5,700 0,5M8
25	1"			R\$ 338,42	1,510 IMB	R\$ 510,01	2,360 IMB	R\$ 669,54	3,380 IMB	R\$ 1078,83	5,750 0,5M8
30	1.3/16"							R\$ 829,99	3,780 0,5M8	R\$ 1412,78	6,460 0,5M8
35	1.3/8"							R\$ 1078,61	4,320 0,5M8	R\$ 1611,29	7,164 0,25M8
40	1.1/2"							R\$ 1139,72	4,480 0,5M8	R\$ 1714,00	7,620 0,25M8

CÓDIGOS, PREÇOS BRUTOS E PESOS POR MILHEIRO - EMBALAGEM MÍNIMA E MASTER - CONSULTE LOTE MÍNIMO



N1 135x120x90

N2 135x120x135

N3 180x120x140

APLICAÇÃO



Utilizado em toda indústria, principalmente em montagens e fixações onde se tem acesso apenas por um lado. Agiliza a produção e proporciona grande resistência (KGF).



MATERIAL DO ILHÓS: ALUMÍNIO
MATERIAL DO PREGO: AÇO CARBONO
COR: PINTADO EPÓXI

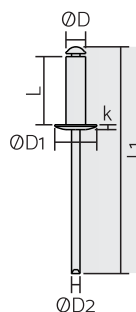

Diâmetro ▶		3/32" (2,4)	1/8" (3,2)	5/32" (4,0)	3/16" (4,8)	1/4" (6,2)					
ØD1 (min.)		5,00	6,30	7,70	9,30	11,90					
k (min.)		1,00	1,30	1,50	1,80	2,00					
ØD2 (min.)		1,40	1,80	2,20	2,60	3,17					
L1 (máx.)		40,00	52,00	55,00	72,00	75,00					
L (mm)	L (")	LINHA 200		LINHA 300		LINHA 400		LINHA 500		LINHA 600	
6	1/4"	R\$ 228,52	2017401 0,580 1M8	R\$ 177,44	2017601 0,980 1M8	R\$ 250,82	2018501 1,480 1M8	R\$ 387,26	2019301 2,380 1M8		
8	5/16"	R\$ 238,37	2017501 0,600 1M8	R\$ 179,95	2017701 1,010 1M8	R\$ 264,92	2018601 1,600 1M8	R\$ 401,23	2019401 2,420 1M8		
10	3/8"	R\$ 241,99	2248901 0,620 1M8	R\$ 195,43	2017801 1,060 1M8	R\$ 286,32	2018701 1,680 1M8	R\$ 419,93	2019501 2,460 1M8	R\$ 664,33	2020501 4,120 0,5M8
12	1/2"	R\$ 250,92	2249001 0,640 1M8	R\$ 204,38	2017901 1,080 1M8	R\$ 301,21	2018801 1,740 1M8	R\$ 429,78	2019601 2,540 1M8	R\$ 668,61	2020601 4,260 0,5M8
14	9/16"			R\$ 213,14	2731501 1,260 1M8	R\$ 342,84	2731601 1,880 1M8	R\$ 450,30	2019701 2,560 1M8	R\$ 706,22	2020701 4,400 0,5M8
16	5/8"			R\$ 214,73	2731301 1,290 1M8	R\$ 346,03	2731401 1,980 1M8	R\$ 469,60	2019801 2,880 1M8	R\$ 778,61	2800401 4,800 0,5M8
19	3/4"			R\$ 233,73	2018201 1,320 1M8	R\$ 371,16	2019001 2,000 1M8	R\$ 532,63	2019901 2,980 1M8	R\$ 780,98	2020801 4,960 0,5M8
22	7/8"			R\$ 302,33	2018301 1,480 1M8	R\$ 450,73	2019101 2,180 1M8	R\$ 594,35	2020001 3,240 1M8	R\$ 858,34	2020901 5,700 0,5M8
25	1"			R\$ 314,25	2018401 1,510 1M8	R\$ 473,58	2019201 2,360 1M8	R\$ 621,72	2020101 3,380 1M8	R\$ 946,60	2021001 5,750 0,5M8
30	1.3/16"							R\$ 770,71	2020201 3,780 0,5M8	R\$ 1001,77	2021101 6,460 0,5M8
35	1.3/8"							R\$ 1001,57	2020301 4,320 0,5M8	R\$ 1311,87	2800501 7,164 0,25M8
40	1.1/2"							R\$ 1058,31	2020401 4,460 0,5M8	R\$ 1496,19	2742801 7,620 0,25M8

CÓDIGOS, PREÇOS BRUTOS E PESOS POR MILHEIRO - EMBALAGEM MÍNIMA E MASTER.



N1 135x120x90

N2 135x120x135

N3 180x120x140

APLICAÇÃO

Utilizado em toda indústria, principalmente em montagens e fixações onde se tem acesso apenas por um lado. Agiliza a produção e proporciona grande resistência (KGF).

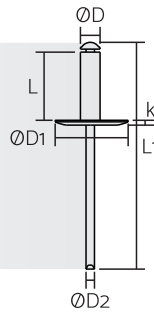

MATERIAL DO ILHÓS: ALUMÍNIO
MATERIAL DO PREGO: AÇO CARBONO
ACABAMENTO: POLIDO BRILHANTE

Diâmetro ▶		1/8" (3,2)	5/32" (4,0)	3/16" (4,8)	1/4" (6,2)				
ØD1 (min.)		8,00	9,30	12,00	15,00				
k (min.)		1,30	1,50	1,80	2,00				
ØD2 (min.)		1,80	2,20	2,60	3,17				
L1 (máx.)		52,00	55,00	72,00	75,00				
L (mm)	L (")	LINHA 300		LINHA 400		LINHA 500		LINHA 600	
8	5/16"	R\$ 159,18	2035401 1,040 1M8	R\$ 234,35	2035801 1,620 1M8	R\$ 354,93	2036301 2,580 0,5M8		
10	3/8"	R\$ 172,88	2035501 1,060 1M8	R\$ 253,29	2035901 1,680 1M8	R\$ 371,48	2036401 2,680 0,5M8	R\$ 591,46	2037701 4,540 0,5M8
12	1/2"	R\$ 180,80	2035601 1,100 1M8	R\$ 266,45	2036101 1,660 1M8	R\$ 380,19	2036501 2,760 0,5M8	R\$ 624,74	2037801 4,590 0,5M8
14	9/16"	R\$ 188,55	2035701 1,260 1M8	R\$ 303,28	2800201 1,920 1M8	R\$ 398,34	2036601 2,960 0,5M8	R\$ 688,77	2037901 4,640 0,5M8
16	5/8"	R\$ 189,95	2800101 1,300 1M8	R\$ 306,10	2800301 1,960 1M8	R\$ 415,41	2036701 3,020 0,5M8	R\$ 690,87	2038101 5,020 0,5M8
19	3/4"			R\$ 328,33	2757401 2,080 1M8	R\$ 471,17	2036901 3,220 0,5M8	R\$ 759,30	2038301 5,106 0,5M8
22	7/8"					R\$ 525,77	2037101 3,460 0,5M8	R\$ 837,38	2038501 5,780 0,5M8
25	1"			R\$ 418,94	3107801 2,420 0,5M8	R\$ 549,98	2037201 3,580 0,5M8	R\$ 886,18	2038601 5,920 0,5M8
30	1.3/16"					R\$ 681,78	2037401 4,020 0,5M8	R\$ 1160,50	2038701 6,680 0,5M8
35	1.3/8"					R\$ 886,00	2037501 4,520 0,5M8	R\$ 1323,56	2038801 7,520 0,25M8
40	1.1/2"					R\$ 936,20	2037601 4,700 0,5M8	R\$ 1407,93	2038901 7,700 0,25M8

CÓDIGOS, PREÇOS BRUTOS E PESOS POR MILHEIRO - EMBALAGEM MÍNIMA E MASTER.



N1 135x120x90

N2 135x120x135

N3 180x120x140

APLICAÇÃO



Utilizado em toda indústria. Aba maior proporciona um melhor acabamento e maior resistência.



MATERIAL DO ILHÓS: ALUMÍNIO
MATERIAL DO PREGO: AÇO CARBONO
ACABAMENTO: POLIDO BRILHANTE

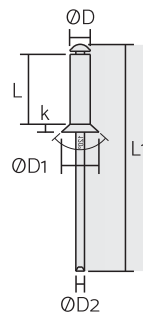

Diâmetro ▶		1/8" (3,2)		5/32" (4,0)		3/16" (4,8)	
ØD1 (min.)		6,30		7,70		9,30	
k (min.)		1,30		1,50		1,80	
ØD2 (min.)		1,80		2,20		2,60	
L1 (máx.)		52,00		55,00		62,00	
L (mm)	L (")	LINHA 300		LINHA 400		LINHA 500	
6	1/4"	R\$	150,15	2031901 0,920 1MB	R\$	212,23	2033001 1,480 1MB
8	5/16"	R\$	152,26	2032101 1,000 1MB	R\$	224,16	2033101 1,520 1MB
10	3/8"	R\$	165,36	2032201 1,030 1MB	R\$	242,27	2033401 1,560 1MB
12	1/2"	R\$	172,94	2032501 1,080 1MB	R\$	254,87	2033701 1,580 1MB
14	9/16"	R\$	180,35	2032801 1,250 1MB	R\$	290,09	2034001 1,820 1MB
16	5/8"	R\$	181,69	2799401 1,300 1MB	R\$	292,80	2799501 1,900 1MB
19	3/4"	R\$	197,77	2032901 1,340 1MB	R\$	314,06	2799601 1,920 1MB
22	7/8"				R\$	381,38	2799701 2,119 1MB
25	1"	R\$	265,90	2766401 1,470 1MB	R\$	400,72	2799801 2,240 1MB
30	1.3/16"					R\$	652,14
40	1.1/2"					R\$	895,50

CÓDIGOS, PREÇOS BRUTOS E PESOS POR MILHEIRO - EMBALAGEM MÍNIMA E MASTER.



N1 135x120x90

N2 135x120x135

N3 180x120x140

APLICAÇÃO

Utilizado principalmente nas instalações de box e montagem de esquadrias.
Aba escareada é desenvolvida para ficar rente ao perfil.

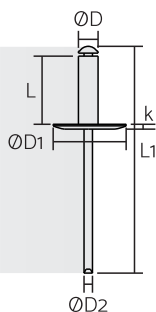

MATERIAL DO ILHOS: ALUMÍNIO
MATERIAL DO PREGO: AÇO CARBONO
ACABAMENTO: POLIDO BRILHANTE

Diâmetro ▶		1/8" (3,2)		5/32" (4,0)		3/16" (4,8)				
ØD1 (min.)		6,30		7,70		9,30				
k (min.)		1,30		1,50		1,80				
ØD2 (min.)		1,80		2,20		2,60				
L1 (máx.)		52,00		48,00		72,00				
L (mm)	L (")	LINHA 300		LINHA 400		LINHA 500				
6	1/4"	R\$ ●	191,09	2006901 0,980 1M8						
8	5/16"	R\$ ●	193,79	2800701 1,040 1M8	R\$ ●	285,29	2730501 1,880 1M8			
10	3/8"	R\$ ●	210,46	2007001 1,060 1M8	R\$ ●	308,35	2007301 1,960 1M8			
12	1/2"	R\$ ●	220,11	2007101 1,120 1M8	R\$ ●	324,38	2007401 1,980 1M8	R\$ ●	462,84	2007601 3,120 1M8
14	9/16"						R\$ ●	484,94	2773001 3,160 1M8	
16	5/8"			R\$ ●	372,65	2007501 2,080 1M8	R\$ ●	505,72	2007701 3,200 0,5M8	
19	3/4"	R\$ ●	251,71	2007201 1,460 1M8	R\$ ●	399,71	2768501 2,160 1M8	R\$ ●	573,60	2007801 3,260 1M8
22	7/8"						R\$ ●	640,07	2248801 3,740 0,5M8	
25	1"	R\$ ●	338,42	2834501 1,480 1M8			R\$ ●	669,54	2007901 3,960 0,5M4	
30	1.3/16"						R\$ ●	829,99	2008001 4,020 0,5M4	
40	1.1/2"						R\$ ●	1.139,72	2769101 4,740 0,5M4	

CÓDIGOS, PREÇOS BRUTOS E PESOS POR MILHEIRO - EMBALAGEM MÍNIMA E MASTER.
 ESTE REBITE DEVE TER FURAÇÃO MAIOR DO QUE O DESCRITO NA NORMA TÉCNICA VISTO CABEÇA DO PREGO TER FORMATO APROPRIADO PARA O REBITE ILHOS)ABRIR EM FLOR



N1 135x120x90

N2 135x120x135

N3 180x120x140

APLICAÇÃO

Utilizado na fixação de peças de fiberglass, coberturas, telhas, etc.
 Fechamento com quatro garras em forma de flor permitindo atingir uma área de até quatro vezes superior ao seu diâmetro.

MATERIAL DO ILHOS: AÇO CARBONO
MATERIAL DO PREGO: AÇO CARBONO
ACABAMENTO: ZINCADO BRANCO

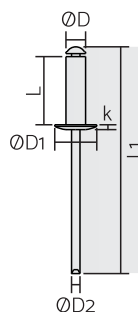

Diâmetro ▶		1/8" (3,2)	5/32" (4,0)	3/16" (4,8)	1/4" (6,2)
ØD1 (min.)		6,30	7,70	9,30	11,90
k (min.)		1,30	1,50	1,80	2,00
ØD2 (min.)		1,80	2,20	2,60	3,17
L1 (máx.)		48,00	48,00	72,00	75,00
L (mm)	L (")	LINHA 300		LINHA 400	
6	1/4"	R\$ 320,80 2004201 1,380 1M8			
8	5/16"	R\$ 331,20 2004301 1,390 1M8	R\$ 440,00 2004901 2,250 1M8	R\$ 581,60 2005501 3,300 0,5M8	
10	3/8"	R\$ 361,60 2004401 1,420 1M8	R\$ 464,00 2005001 2,410 1M8	R\$ 616,00 2005601 3,760 0,5M8	R\$ 1270,40 2006401 7,440 0,25M8
12	1/2"	R\$ 372,80 2004501 1,540 1M8	R\$ 495,20 2005101 2,610 1M8	R\$ 670,40 2005701 3,960 0,5M8	R\$ 1300,00 2006501 7,760 0,25M8
14	9/16"	R\$ 392,00 2004601 1,600 1M8	R\$ 528,80 2005201 2,710 0,5M8	R\$ 689,60 2005801 4,360 0,5M8	
16	5/8"	R\$ 407,47 2004701 1,750 1M8	R\$ 551,20 2005301 2,920 0,5M8	R\$ 743,20 2005901 4,600 0,5M8	R\$ 1399,20 2006601 8,550 0,25M8
19	3/4"	R\$ 438,40 2004801 1,870 1M8	R\$ 624,80 2005401 3,045 0,5M8	R\$ 771,20 2006001 4,780 0,5M8	R\$ 1567,20 2006701 9,480 0,2M10
22	7/8"			R\$ 876,00 2006101 4,980 0,25M8	
25	1"			R\$ 955,20 2006201 5,430 0,25M8	R\$ 1737,60 2006801 10,680 0,25M8
30	1.3/16"			R\$ 1080,80 2006301 6,250 0,25M8	

CÓDIGOS, PREÇOS BRUTOS E PESOS POR MILHEIRO - EMBALAGEM MÍNIMA E MASTER.



N1 135x120x90

N2 135x120x135

N3 180x120x140

APLICAÇÃO

Utilizado em toda indústria, principalmente em montagens e fixações onde só se tem acesso por um lado. Fixador de maior resistência, tração e cisalhamento.

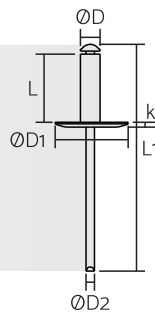
MATERIAL DO ILHOS: AÇO INOX
MATERIAL DO PREGO: AÇO INOX

Diâmetro ▶		1/8" (3,2)	5/32" (4,0)	3/16" (4,8)
ØD1 (min.)		6,30	7,70	9,30
k (min.)		1,30	1,50	1,80
ØD2 (min.)		1,80	2,20	2,60
L1 (máx.)		48,00	48,00	72,00
L (mm)	L (")	LINHA 300		LINHA 500
6	1/4"	R\$ 715,20 <small>2002601 1,250 1M8</small>		
8	5/16"	R\$ 749,60 <small>2002701 1,355 1M8</small>	R\$ 1087,20 <small>2003101 2,215 1M8</small>	R\$ 1528,00 <small>2003501 3,280 0,5M8</small>
10	3/8"	R\$ 823,20 <small>2002801 1,420 1M8</small>	R\$ 1164,80 <small>2003201 2,360 1M8</small>	R\$ 1640,80 <small>2003601 3,500 0,5M8</small>
12	1/2"	R\$ 858,40 <small>2002901 1,550 1M8</small>	R\$ 1244,00 <small>2003301 2,560 1M8</small>	R\$ 1764,00 <small>2003701 3,740 0,5M8</small>
14	9/16"			R\$ 1858,40 <small>2731701 4,320 0,5M8</small>
16	5/8"	R\$ 991,20 <small>2003001 1,800 1M8</small>	R\$ 1409,60 <small>2003401 2,900 0,5M8</small>	R\$ 2028,00 <small>2003801 4,500 0,5M8</small>
19	3/4"			R\$ 2118,40 <small>2003901 4,540 0,5M8</small>
22	7/8"			R\$ 2387,20 <small>2004001 4,980 0,25M8</small>
25	1"			R\$ 2652,80 <small>2004101 5,540 0,25M8</small>

CÓDIGOS, PREÇOS BRUTOS E PESOS POR MILHEIRO - EMBALAGEM MÍNIMA E MASTER.



N1 135x120x90

N2 135x120x135

N3 180x120x140

APLICAÇÃO

Utilizado em toda indústria, principalmente em montagens e fixações de peças onde só se tem acesso por um lado. Material de alta resistência a tração e cisalhamento. 100% inoxidável.

MATERIAL DO ILHOS: ALUMÍNIO
MATERIAL DO PREGO: AÇO CARBONO
ACABAMENTO: POLIDO BRILHANTE

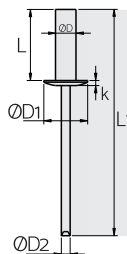

Diâmetro ▶		1/8" (3,2)							
ØD1 (min.)		6,30	7,70	9,30	11,90				
k (min.)		1,30	1,50	1,80	2,00				
ØD2 (min.)		1,80	2,20	2,60	3,17				
L (mm)	L (")	LINHA 300		LINHA 400		LINHA 500		LINHA 600	
6	1/4"	R\$ 475,20	2000601 0,780 1M8						
8	5/16"	R\$ 489,60	2000701 0,840 1M8	R\$ 632,00	2001101 1,440 1M8	R\$ 844,00	2001501 2,160 0,5M4		
10	3/8"	R\$ 503,20	2000801 0,900 1M8	R\$ 660,00	2001201 1,540 1M8	R\$ 874,40	2001601 2,280 0,5M8	R\$ 2040,00	2002301 4,650 0,5M4
12	1/2"	R\$ 534,40	2000901 0,960 1M8	R\$ 700,00	2001301 1,580 0,5M4	R\$ 929,60	2001701 2,480 0,5M8	R\$ 2260,00	2002401 5,340 0,35M4
14	9/16"					R\$ 980,00	2001801 2,540 0,5M8		
16	5/8"	R\$ 646,40	2001001 1,180 1M8	R\$ 797,60	2001401 1,800 0,5M8	R\$ 999,20	2001901 2,820 0,5M4	R\$ 2319,20	2002501 5,380 0,5M4
19	3/4"					R\$ 1111,20	2002001 2,900 0,5M4	R\$ 2559,20	2761401 6,360 0,25M4
22	7/8"					R\$ 1330,40	2002101 3,320 0,5M4		
25	1"					R\$ 1588,00	2002201 3,500 0,5M4		

CÓDIGOS, PREÇOS BRUTOS E PESOS POR MILHEIRO - EMBALAGEM MÍNIMA E MASTER.

- N1 135x120x90
- N2 135x120x135
- N3 180x120x140

APLICAÇÃO

Utilizado em equipamentos de refrigeração, câmaras de ar, calhas, caixas e tanques com estanqueidade, janelas, veículos, etc.
 Hermeticidade garantida!



MATERIAL DO ILHOS: AÇO CARBONO
MATERIAL DO PREGO: AÇO CARBONO
ACABAMENTO: ZINCADO BRANCO

Diâmetro ▶	NB-510	NB-515	NB-614	NB-619	NB-621
ØD (máx.)	4,90	4,90	6,60	6,60	6,60
ØD1 (máx.)	3,10	3,10	4,10	4,10	4,10
Kgf (Tração)	454	454	840	840	840
Kgf (Cisalhamento)	590	590	1090	1090	1090
PREÇO	R\$ 3.200,00 <small>2770101 3.830 1M</small>	R\$ 3.321,60 <small>2770201 4.082 1M</small>	R\$ 4.536,40 <small>2770301 4.335 1M</small>	R\$ 5.066,67 <small>3282001 8.790 2%</small>	R\$ 5.600,00 <small>2770401 10.205 2,5%</small>

REBITE DE REPUXO NEWLOCK
DIN 7337



MATERIAL DO ILHOS: AÇO CARBONO
MATERIAL DO PREGO: AÇO CARBONO
ACABAMENTO: ZINCADO BRANCO

Diâmetro ▶	NL-310	NL-312	NL-410	NL-512	NL-612
ØD (máx.)	3,28	3,28	4,08	4,88	5,96
ØD1 (máx.)	2,10	2,10	2,70	3,10	3,70
Kgf (Tração)	106	106	255	310	4,25
Kgf (Cisalhamento)	100	100	285	345	5,25
PREÇO	R\$ 1.128,00 <small>2769701 1.520 1M</small>	R\$ 1.353,60 <small>3281901 2.070 1M</small>	R\$ 1.590,40 <small>2769801 2.620 1M</small>	R\$ 1.948,80 <small>2769901 3.920 5%</small>	R\$ 2.816,00 <small>2770001 5.500 2,5%</small>

CÓDIGOS, PREÇOS BRUTOS E PESOS POR MILHEIRO - EMBALAGEM MÍNIMA E MASTER.

- N1 135x120x90
- N2 135x120x135
- N3 180x120x140

APLICAÇÃO

Rebite estrutural com acabamento hermetico, grande resistência a tração e vibração. Duplo travamento. Aplicado com rebitador especial.

MATERIAL: ALUMÍNIO
ACABAMENTO: POLIDO BRILHANTE

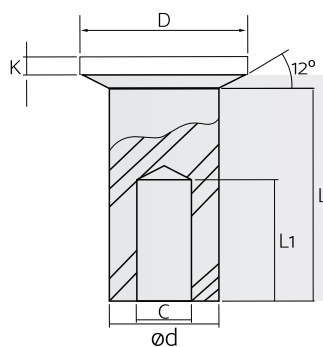

Diâmetro ▶		3,35	4,65	6,35	7,70
ØD (máx.)		7,50	9,52	12,50	15,87
k (máx.)		0,60	1,20	0,70	1,40
C (máx.)		2,20	3,60	4,00	4,60
L1 (máx.)		4,50	4,50	7,00	9,00
L (mm)	L (")				
4,76	3/16"	R\$ 40,53 3419101 0,190 10%			
6,35	1/4"	R\$ 51,20 3419201 0,240 10%	R\$ 88,87 3419901 0,430 10%		
7,93	5/16"	R\$ 59,73 2173101 0,280 10%	R\$ 104,37 3420001 0,505 10%		
9,52	3/8"	R\$ 74,67 2173201 0,350 10%	R\$ 109,53 3420101 0,530 10%	R\$ 194,00 3421701 0,970 5%	
11,11	7/16"	R\$ 80,00 3419301 0,375 10%	R\$ 119,87 3420201 0,580 10%		
12,70	1/2"	R\$ 83,20 3419401 0,390 10%	R\$ 159,13 3420301 0,770 10%	R\$ 242,00 3421801 1,210 5%	R\$ 364,00 3422801 1,950 5%
15,87	5/8"	R\$ 102,40 3419501 0,480 10%	R\$ 181,87 3420401 0,980 10%	R\$ 304,00 3421901 1,520 5%	R\$ 434,93 3422901 2,330 5%
19,05	3/4"		R\$ 212,87 3420501 1,030 10%	R\$ 350,00 3422001 1,750 5%	R\$ 524,53 3423001 2,810 5%
22,22	7/8"		R\$ 239,73 3420601 1,160 10%	R\$ 406,00 2742201 2,030 5%	R\$ 582,40 3423101 3,120 5%
25,40	1"		R\$ 268,67 3420701 1,300 10%	R\$ 454,00 2842901 2,270 5%	R\$ 683,20 3423201 3,660 5%

CÓDIGOS, PREÇOS BRUTOS E PESOS POR MILHEIRO - EMBALAGEM MÍNIMA E MASTER.



N1 135x120x90

N2 135x120x135

N3 180x120x140

APLICAÇÃO

Utilizado para montagens de escada de alumínio, rodas de bagagens, mochilas e em produtos com partes móveis.

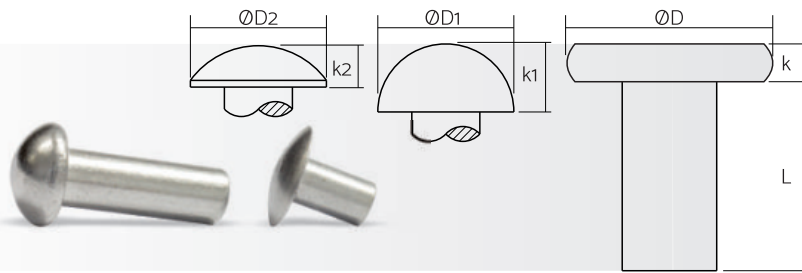

MATERIAL: ALUMÍNIO 1350/5005
ACABAMENTO: POLIDO BRILHANTE

Diâmetro ▶	1/8"		5/32"		3/16"		1/4"		5/16"	
ØD (máx.)	6,60		8,20		9,82		13,08		16,28	
k (máx.)	1,21		1,49		1,75		2,31		2,87	
ØD1 (máx.)	5,96		7,36		8,83		11,68		14,52	
k1 (máx.)	2,54		3,14		3,73		4,97		6,17	
ØD2 (máx.)	7,54		9,34		12,10		14,98		18,59	
K2 (máx.)	1,21		1,49		2,20		2,31		2,87	
L (")										
3/16"	R\$ 191,04	2056201 2064601 2073101	R\$ 156,18	2057601 2066401 2074501						
1/4"	R\$ 191,04	2056301 2064701 2073201	R\$ 156,18	2057701 2066501 2074601	R\$ 156,18	2059401 2068201 2076301				
5/16"	R\$ 191,04	2056401 2064801 2073301	R\$ 156,18	2057801 2066601 2074701	R\$ 156,18	2059501 3204401 2076401	R\$ 156,18	2061201 2070001 2078101		
3/8"	R\$ 191,04	2056501 2064901 2073401	R\$ 156,18	2057901 2066701 2074801	R\$ 156,18	2059601 2984301 2076501	R\$ 156,18	2061401 2070101 2078201	R\$ 156,18	2062901 2071601 2079601
7/16"	R\$ 191,04	2056601 2065001 2073501	R\$ 156,18	2058001 2066801 2074901	R\$ 156,18	2059701 2068601 2076601	R\$ 156,18	2061501 2070201 2078301	R\$ 156,18	2063001 2071701 2079701
1/2"	R\$ 191,04	2056701 2065101 2073601	R\$ 156,18	2058101 2066901 2075001	R\$ 156,18	2059801 2986101 2076701	R\$ 156,18	2061601 2070301 2078401	R\$ 156,18	2063101 2071801 2079801
9/16"	R\$ 191,04	2056801 2065201 2073701	R\$ 156,18	2058201 2067001 2075101	R\$ 156,18	2059901 2068701 2076801	R\$ 156,18	2061701 2070601 2078501	R\$ 156,18	2063201 2071901 2079901
5/8"	R\$ 191,04	2056901 2065301 2073801	R\$ 156,18	2058301 2067101 2075201	R\$ 156,18	2060001 2986201 2076901	R\$ 156,18	2061801 2070501 2078601	R\$ 156,18	2063301 2072001 2080001
3/4"	R\$ 191,04	2057001 2065401 2073901	R\$ 156,18	2058401 2067201 2075301	R\$ 156,18	2060101 3102101 2077001	R\$ 156,18	2061901 2070401 2078701	R\$ 156,18	2063401 2072101 2080101
7/8"	R\$ 191,04	2057101 2065501 2074001	R\$ 156,18	2058501 2067301 2075401	R\$ 156,18	2060201 3107501 2077101	R\$ 156,18	2062001 2070701 2078801	R\$ 156,18	2063501 2072201 2080201
1"	R\$ 191,04	2057201 2065601 2074101	R\$ 156,18	2058601 2067401 2075501	R\$ 156,18	2060301 2068901 2077201	R\$ 156,18	2062101 2070801 2078901	R\$ 156,18	2063601 2072301 2080301
1.1/4"	R\$ 191,04	2057401 2065801 2074301	R\$ 156,18	2058801 2067601 2075701	R\$ 156,18	2060501 2069301 2077501	R\$ 156,18	2062301 2071001 2079001	R\$ 156,18	2063801 2072501 2080501
1.1/2"	R\$ 191,04	2057501 2065901 2074401	R\$ 156,18	2058901 2067701 2075801	R\$ 156,18	2060601 2069401 2077401	R\$ 156,18	2062401 2071101 2079101	R\$ 156,18	2063901 2072601 2080401
1.3/4"			R\$ 156,18	2059101 2067901 2076001	R\$ 156,18	2060801 2069501 2077801	R\$ 156,18	2062601 2071301 2079301	R\$ 156,18	2064101 2072801 2080701
2"			R\$ 156,18	2059301 2068101 2076201	R\$ 156,18	2061001 2069801 2077901	R\$ 156,18	2062801 2071501 2079501	R\$ 156,18	2064301 2073001 2080901

CÓDIGOS, PREÇOS BRUTOS E PESOS POR QUILO - EMBALAGEM MÍNIMA E MASTER.



N1 135x120x90

N2 135x120x135

N3 180x120x140



APLICAÇÃO



Utilizado na fixação de duas ou mais peças rebitáveis, aplicado através de martelo pneumático ou prensas. Proporciona excelente acabamento.



MATERIAL: AÇO SAE 1006
ACABAMENTO: POLIDO

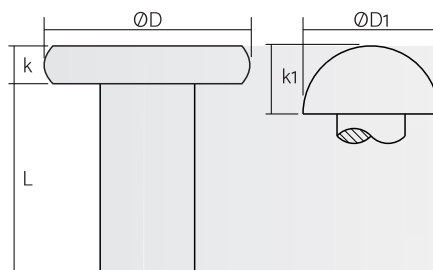

Diâmetro ▶	1/8"	5/32"	3/16"	1/4"	5/16"	3/8"	1/2"
ØD (máx.)	6,60	8,20	9,82	13,08	16,28	19,53	25,80
k (máx.)	1,21	1,49	1,75	2,31	2,87	3,42	4,50
ØD1 (máx.)	5,96	7,36	8,83	11,68	14,52	17,37	23,01
k1 (máx.)	2,54	3,14	3,73	4,97	6,17	7,39	10,31
L (")							
1/4"	R\$ 96,67 2081101 2085001	R\$ 92,00 2736701 2085301	R\$ 72,35 2082401 2817201				
5/16"	R\$ 96,67 2081201 2833201	R\$ 92,00 2732601	R\$ 72,35 2255301 2817301	R\$ 72,35 2083301 2818601			
3/8"	R\$ 96,67 2081401 2732201	R\$ 92,00 2255101 2815701	R\$ 72,35 2082501 2085501	R\$ 72,35 2083401 2767601	R\$ 72,35 2771201 2769001	R\$ 72,35 2827801 2744701	
7/16"	R\$ 96,67 2081501	R\$ 92,00 3336901	R\$ 72,35 2811501				
1/2"	R\$ 96,67 2081601 2085201	R\$ 92,00 2081901 2815801	R\$ 72,35 2082601 2085601	R\$ 72,35 2083501 2732401	R\$ 72,35 2084101 2773301	R\$ 72,35 2082101 2821101	
9/16"	R\$ 96,67 2081701		R\$ 72,35 3254901				
5/8"	R\$ 96,67 2081301 2833301	R\$ 92,00 2255201 2815901	R\$ 72,35 2082801 2085701	R\$ 72,35 2083601 2818701	R\$ 72,35 2084201 2086201	R\$ 72,35 2827901 2821201	
3/4"	R\$ 96,67 2771101 2833401	R\$ 92,00 2752701 2085401	R\$ 72,35 2082701 2085801	R\$ 72,35 2083801 2767701	R\$ 72,35 2084301 2745601	R\$ 72,35 2082201 2086501	R\$ 80,00 2831301 2824001
7/8"	R\$ 96,67 2813701 2833501	R\$ 92,00 2774201 2816001	R\$ 72,35 2255401 2085901	R\$ 72,35 2083701 2818801	R\$ 72,35 2084401 2086301	R\$ 72,35 2082301 2821301	R\$ 80,00 2831401 2824101
1"	R\$ 96,67 2832901 2833601	R\$ 92,00 2082001 2816101	R\$ 72,35 2082901 2086001	R\$ 72,35 2813801 2767801	R\$ 72,35 2084501 2423401	R\$ 72,35 2828001	R\$ 80,00 2831501 2086901
1.1/4"	R\$ 96,67 2813901 2833701	R\$ 92,00 2814601 2816201	R\$ 72,35 2083101 2817401	R\$ 72,35 2731201 2773201	R\$ 72,35 2084701 2732501	R\$ 72,35 2828101 2255501	R\$ 80,00 2831601 2087001
1.1/2"	R\$ 96,67 2814101 2833901	R\$ 92,00 2774301 2816301	R\$ 72,35 2083001 2817601	R\$ 72,35 2742701 2086101	R\$ 72,35 2084601 2086401	R\$ 72,35 2828301 2768401	R\$ 80,00 2831801 2768201
1.3/4"	R\$ 96,67 2814201 2834101	R\$ 92,00 2814901 2816601	R\$ 72,35 2083201 2818401	R\$ 72,35 2780101 2819101	R\$ 72,35 2827001 2820301	R\$ 72,35 2828501 2821601	R\$ 80,00 2832001 2824301
2"	R\$ 96,67 2814501 2834301	R\$ 92,00 2736501 2816801	R\$ 72,35 2769601 2817901	R\$ 72,35 2084001 2819301	R\$ 72,35 2827201 2820501	R\$ 72,35 2828701 2736601	R\$ 80,00 2832201 2768301

CÓDIGOS, PREÇOS BRUTOS E PESOS POR QUILO - EMBALAGEM MÍNIMA E MASTER.



N1 135x120x90

N2 135x120x135

N3 180x120x140

CHATA
REDONDA

APLICAÇÃO

Utilizado na fixação de duas ou mais peças rebitáveis, aplicado através de martelinho pneumático ou prensas. Proporciona excelente acabamento.

MATERIAL: AÇO SAE 1008/1010
ACABAMENTO: BICROMATIZADO

ABA PLANA

	Esp. rebitável	Preço	
NP-420	0,25 - 2,0mm	R\$ 74,78	2171801
NP-440	2,0 - 4,0mm	R\$ 74,78	2249501
NP-530	0,25 - 3,0mm	R\$ 81,07	2172101
NP-550	3,0 - 5,5mm	R\$ 81,07	2172201
NP-630	0,5 - 3,0mm	R\$ 99,31	2172301
NP-655	3,0 - 5,5mm	R\$ 99,31	2172401
NP-830	0,5 - 3,0mm	R\$ 157,07	2172501
NP-855	3,0 - 5,5mm	R\$ 157,07	2172601
NP-1035	1,0 - 3,5mm	R\$ 186,96	2172701
NP-1060	3,5 - 6,0mm	R\$ 186,96	2172801

ABA ESCAREADA

	Esp. rebitável	Preço	
NE-430	1,6 - 3,0mm	R\$ 74,78	2170101
NE-450	3,0 - 5,0mm	R\$ 74,78	2170201
NE-540	1,8 - 4,0mm	R\$ 81,07	2173301
NE-565	4,0 - 6,5mm	R\$ 81,07	2170301
NE-640	2,0 - 4,0mm	R\$ 99,31	2170501
NE-665	4,0 - 6,5mm	R\$ 99,31	2170601
NE-840	2,0 - 4,0mm	R\$ 157,07	2170801
NE-865	4,0 - 6,5mm	R\$ 157,07	2170901
NE-1040	2,0 - 4,0mm	R\$ 186,96	2171101
NE-1065	4,0 - 6,5mm	R\$ 186,96	2171201

CÓDIGOS, PREÇOS BRUTOS E PESOS POR CENTO - EMBALAGEM MÍNIMA E MASTER.

CONSULTE TAMBÉM: ABA EXTRA FINA, CORPO RECARTEILHADO, CORPO SEXTAVADO, ZINCADO BRANCO - LOTE MÍNIMO



N1 135x120x90

N2 135x120x135

N3 180x120x140

APLICAÇÃO



Utilizado na fixação de duas ou mais peças rebitáveis, aplicado através de martelo pneumático ou prensas. Proporciona excelente acabamento.



Manual New-One NF-100



R\$ 161,50
2000301

- | | |
|-------------------------------------|--------------------------------------|
| NF 100-01: Cabo | NF 100-08: Anel trava |
| NF 100-02: Eixo trava | NF 100-09: Eixo de articulação |
| NF 100-03: Mola | NF 100-10: Corpo |
| NF 100-04: Impulsor | NF 100-11: Bico para rebite de 1/8" |
| NF 100-05: Mordentes | NF 100-12: Bico para rebite de 5/32" |
| NF 100-06: Eixo do conjunto | NF 100-13: Bico para rebite de 3/16" |
| NF 100-07: Mola de abertura do cabo | |

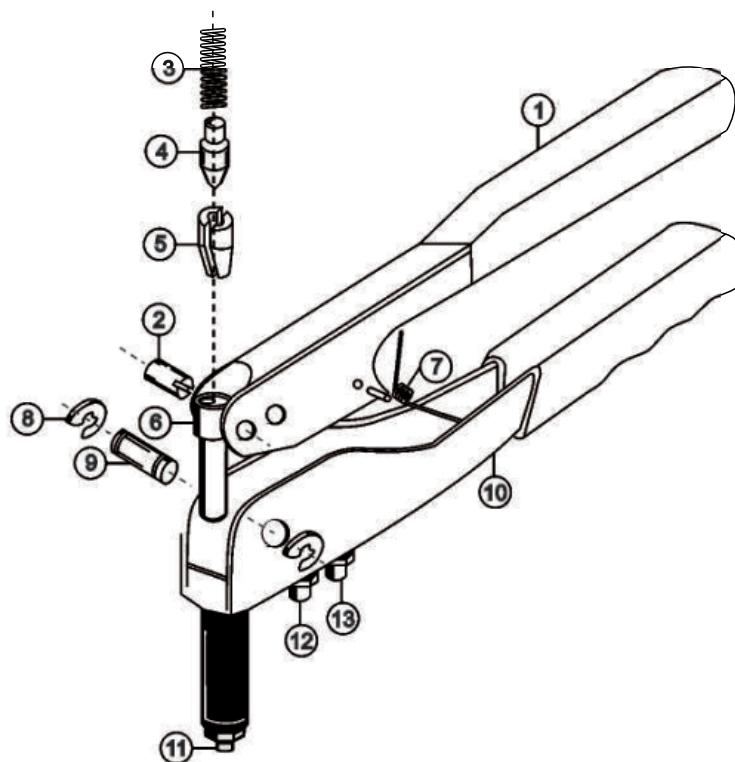

Pneumático NF-500



R\$ 3.396,50
2000201

- | | |
|---|---|
| NF 500-01: Bico para rebite $\varnothing 3,2 - 1/8"$ | NF 500-20: Tampa do punho |
| NF 500-01 A: Bico para rebite $\varnothing 4,0 - 5/32"$ | NF 500-21: Gatilho |
| NF 500-01 B: Bico para rebite $\varnothing 4,8 - 3/16"$ | NF 500-22: Haste do gatilho |
| NF 500-02: Capa externa | NF 500-23: Alavanca do gatilho |
| NF 500-03: Alojamento dos mordentes | NF 500-24: Pino elástico |
| NF 500-04: Mordentes | NF 500-25: Intensificador com amortecedor |
| NF 500-05: Impulsor do mordente | NF 500-26: Amortecedor |
| NF 500-06: Anel de vedação | NF 500-27: Pino elástico |
| NF 500-07: União do pistão | NF 500-28: Pino elástico |
| NF 500-08: Mola do impulsor do mordente | NF 500-29: Pino elástico |
| NF 500-09: Arruela trava | NF 500-30: Porca trava |
| NF 500-10: Contra porca | NF 500-31: Anel de vedação |
| NF 500-11: Anel de vedação | NF 500-32: Válvula |
| NF 500-12: Anel de vedação | NF 500-33: Mola da válvula |
| NF 500-13: Punho | NF 500-34: Anel de vedação |
| NF 500-14: Pistão hidráulico | NF 500-35: Anel de vedação |
| NF 500-15: Anel de vedação | NF 500-36: Disco da válvula |
| NF 500-16: Anel de vedação | NF 500-37: Mola da válvula |
| NF 500-17: Molda externa de retorno | NF 500-38: Anel de vedação |
| NF 500-18: Mola interna de retorno | NF 500-39: Niple |
| NF 500-19: Anel de vedação | NF 500-40: Anel de vedação |

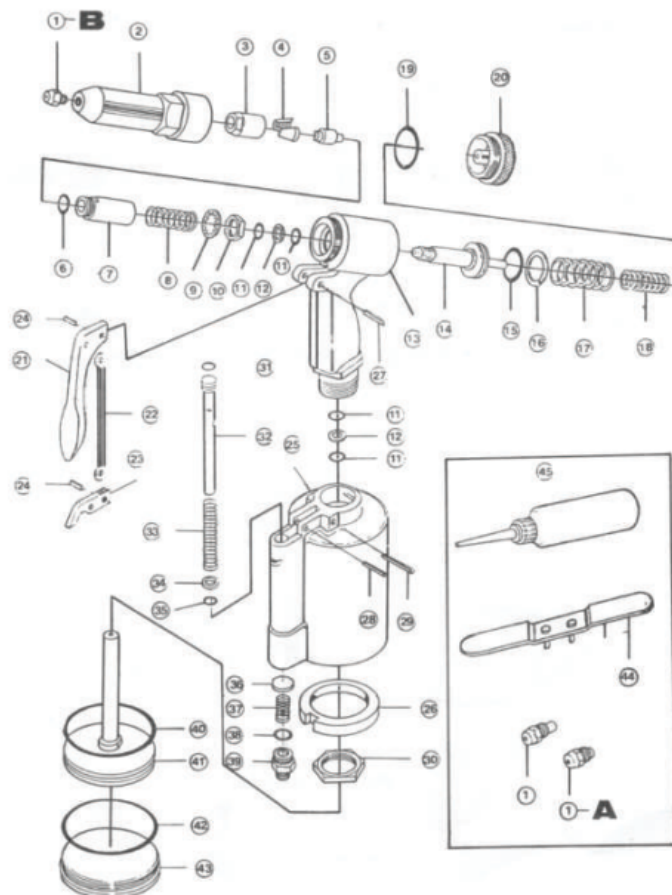

- NF 500-41: Pistão pneumático
 NF 500-42: Anel de vedação
 NF 500-43: Tampa do intensificador
 NF 500-44: Chave fixa

NF 500-45: Óleo hidráulico

Manual Alavanca NF-200



R\$ 587,10
2000001

NF 200-01: Eixo de acionamento	NF 200-08: Corpo
NF 200-02: Mola	NF 200-09: Pino do corpo
NF 200-03: Impulsor	NF 200-10: Trava
NF 200-04: Mordentes	NF 200-11: Haste
NF 200-05: Alojamento dos mordentes	NF 200-12: Trava
NF 200-06: Alojamento externo	NF 200-13: Pino da haste
NF 200-07: Bico para rebite Ø1/8"	NF 200-14: Cabo
NF 200-07A: Bico para rebite Ø5/32"	NF 200-15: Haste
NF 200-07B: Bico para rebite Ø3/16"	NF 200-16: Arruela trava

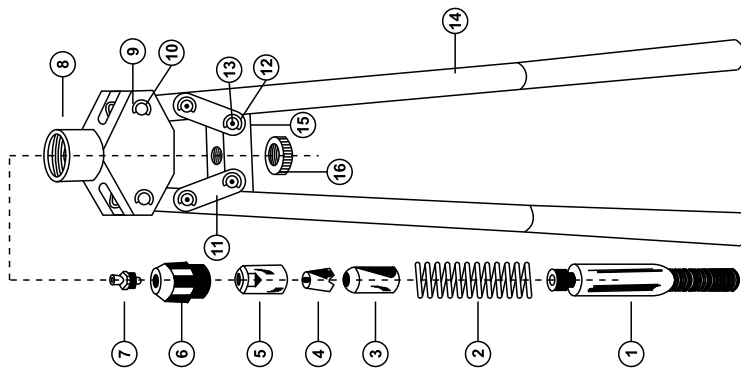

Manual Rosca Interna Alavanca NF-400

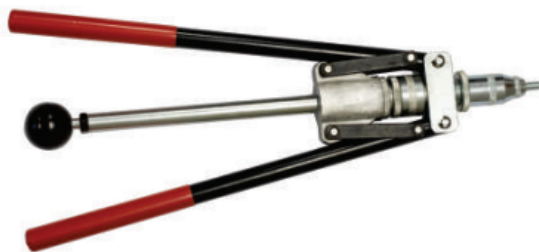

R\$ 2.059,90
2000101

NF 400-01: Eixo de acionamento	NF 400-07A: Bico para rebite M5
NF 400-02: Parafuso de tração M4	NF 400-07B: Bico para rebite M6
NF 400-02A: Parafuso de tração M5	NF 400-07C: Bico para rebite M8
NF 400-02B: Parafuso de tração M6	NF 400-07D: Bico para rebite M10
NF 400-02C: Parafuso de tração M8	NF 400-08: Cabo
NF 400-02D: Parafuso de tração M10	NF 400-09: Eixo de articulação
NF 400-03: Arruela trava	NF 400-10: Haste de articulação
NF 400-04: Porca de ajuste	NF 400-11: Eixo de articulação
NF 400-05: Corpo do suporte do cabo	NF 400-12: Rolamento
NF 400-06: Arruela trava do bico	NF 400-13: Guia do acionador
NF 400-07: Bico para rebite M4	NF 400-14: Sem fim

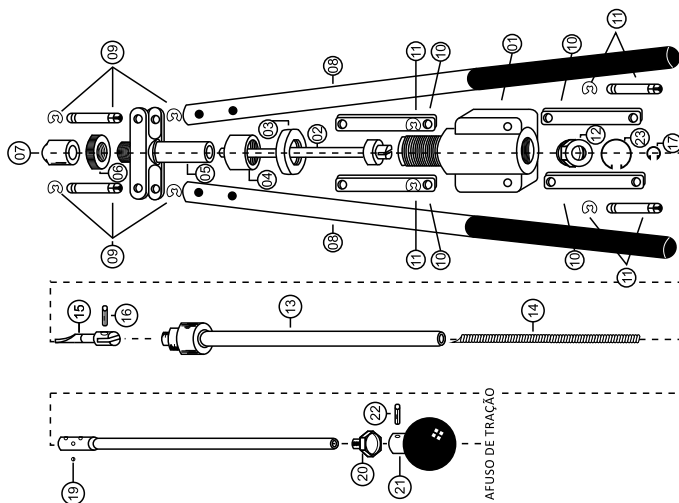

NF 400-15: Acoplamento do par	NF 400-20: Porca
NF 400-16: Pino	NF 400-21: Manopla
NF 400-17: Anel	NF 400-22: Pino
NF 400-18: Acionador do sem fim	NF 400-23: Trava do rolamento
NF 400-19: Esfera	

Manual Rosca Interna NF-300



R\$ 521,30
2000401

NF 300-01: Cabo	NF 300-08A: Bico para rebite M4
NF 300-02: Eixo trava	NF 300-08B: Bico para rebite M5
NF 300-03: Eixo do conjunto	NF 300-09: Porca do bico
NF 300-04: Anel trava	
NF 300-05: Corpo	
NF 300-06: Parafuso de tração M3	
NF 300-06A: Parafuso de tração M4	
NF 300-06B: parafuso de tração M5	
NF 300-07: Manipulo do parafuso de tração	
NF 300-08: Bico para rebite M3	

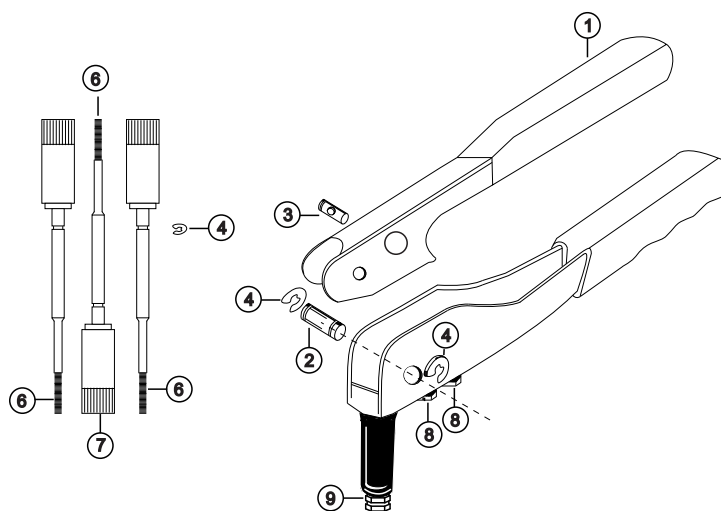

PREGO-FIX



LANÇAMENTO



COM CABEÇA



SEM CABEÇA



CABEÇA DUPLA



ARDOX
COM CABEÇA



ARDOX
SEM CABEÇA



ANELADO



TELHEIRO

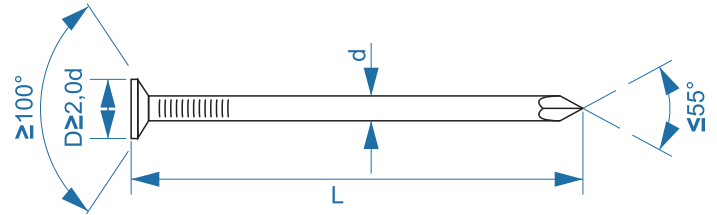

CÓDIGO	TAMANHO		QTD. APROX. DE PREGOS POR KGS	QTD. KGS POR EMB	QTD DE KGS POR CAIXA	PREÇO POR KGS	DIÂMETRO (d)		COMPRIMENTO (L)	
	JP x LPP	POL x BWG					NOMINAL (mm)	TOLERÂNCIA (mm)	NOMINAL (mm)	TOLERÂNCIA (mm)
3468401	6 x 6	1/2 x 19	9.310	0,5	10	R\$ 93,44	1,1	±0,08	13,8	±1,0 d
3468501	8 x 8	3/4 x 18	4.939	0,5	10	R\$ 52,48	1,3	±0,08	18,4	±1,0 d
3468601	10 x 10	7/8 x 17	3.250	0,5	10	R\$ 42,88	1,5	±0,08	23,0	±1,0 d
3468701	11 x 11	1 x 16	2.466	0,5	10	R\$ 36,96	1,6	±0,08	25,3	±1,0 d
3468801	12 x 12	-	1.632	1	20	R\$ 31,04	1,8	±0,08	27,6	±1,0 d
3468901	13 x 15	1 1/4 x 15	1.062	1	20	R\$ 29,34	2,0	±0,08	34,5	±1,0 d
3469001	13 x 18	1 1/2 x 15	922	1	20	R\$ 29,34	2,0	±0,08	41,4	±1,0 d
3469101	14 x 15	1 1/4 x 14	814	1	20	R\$ 29,34	2,2	±0,08	34,5	±1,0 d
3469201	14 x 18	1 1/2 x 14	708	1	20	R\$ 29,34	2,2	±0,08	41,4	±1,0 d
3469301	14 x 21	2 x 14	610	1	20	R\$ 29,34	2,2	±0,08	48,3	±1,0 d
3469401	15 x 15	1 1/4 x 13	672	1	20	R\$ 26,56	2,4	±0,10	34,5	±1,0 d
3469501	15 x 18	1 1/2 x 13	582	1	20	R\$ 26,56	2,4	±0,10	41,4	±1,0 d
3469601	15 x 21	2 x 13	477	1	20	R\$ 26,56	2,4	±0,10	48,3	±1,0 d
3469701	16 x 18	1 1/2 x 12	476	1	20	R\$ 25,44	2,7	±0,10	41,4	±1,0 d
3469801	16 x 21	2 x 12	393	1	20	R\$ 25,44	2,7	±0,10	48,3	±1,0 d
3469901	16 x 24	2 1/4 x 12	354	1	20	R\$ 25,44	2,7	±0,10	55,2	±1,0 d
3470001	17 x 21	2 x 11	291	1	20	R\$ 23,84	3,0	±0,10	48,3	±1,0 d
3470101	17 x 24	2 1/4 x 11	266	1	20	R\$ 23,84	3,0	±0,10	55,2	±1,0 d
3470201	17 x 27	2 1/2 x 11	242	1	20	R\$ 23,84	3,0	±0,10	62,1	±1,0 d
3470301	17 x 30	2 3/4 x 11	210	1	20	R\$ 23,84	3,0	±0,10	69,0	±1,0 d
3470401	18 x 24	2 1/4 x 10	230	1	20	R\$ 23,10	3,4	±0,10	55,2	±1,0 d
3470501	18 x 27	2 1/2 x 10	198	1	20	R\$ 23,10	3,4	±0,10	62,1	±1,0 d
3470601	18 x 30	2 3/4 x 10	187	1	20	R\$ 23,10	3,4	±0,10	69,0	±1,0 d
3470701	18 x 36	3 1/4 x 10	155	1	20	R\$ 23,10	3,4	±0,10	82,8	±1,0 d
3470801	19 x 27	2 1/2 x 9	155	1	20	R\$ 23,10	3,9	±0,10	62,1	±1,0 d
3470901	19 x 30	2 3/4 x 9	143	1	20	R\$ 23,10	3,9	±0,10	69,0	±1,0 d
3471001	19 x 36	3 1/4 x 9	121	1	20	R\$ 23,10	3,9	±0,10	82,8	±1,0 d
3471101	20 x 30	2 3/4 x 7	106	1	20	R\$ 23,10	4,4	±0,10	69,0	±1,0 d
3471201	20 x 42	3 3/4 x 7	77	1	20	R\$ 23,10	4,4	±0,10	96,6	±1,0 d
3471301	20 x 48	4 1/4 x 7	67	1	20	R\$ 23,10	4,4	±0,10	110,4	±1,0 d
3471401	22 x 42	3 3/4 x 5	49	1	20	R\$ 23,10	5,4	±0,10	96,6	±1,0 d
3471501	22 x 48	4 1/4 x 5	48	1	20	R\$ 23,10	5,4	±0,10	110,4	±1,0 d

MATERIAL: AÇO BAIXO CARBONO
 ACABAMENTO: POLIDO BRILHANTE
 NCM: 7317.00.90
 IPI: 10%

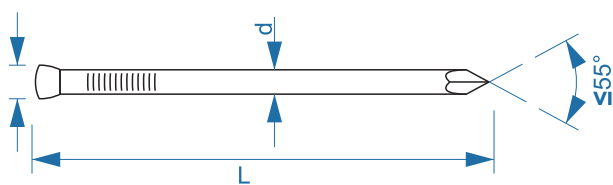

CÓDIGO	TAMANHO		QTD. APROX. DE PREGOS POR KGS	QTD. KGS POR EMB	QTD DE KGS POR CAIXA	PREÇO POR KGS	DIÂMETRO (d)		COMPRIMENTO (L)	
	JP x LPP	POL x BWG					NOMINAL (mm)	TOLERÂNCIA (mm)	NOMINAL (mm)	TOLERÂNCIA (mm)
3471601	6 x 6	1/2 x 19	9.776	0,5	10	R\$ 93,44	1,1	±0,08	13,8	±1,0d
3471701	8 x 8	3/4 x 18	4.938	0,5	10	R\$ 52,48	1,3	±0,08	18,4	±1,0d
3471801	10 x 10	7/8 x 17	2.941	0,5	10	R\$ 42,88	1,5	±0,08	23,0	±1,0d
3471901	12 x 12	-	1.613	1	20	R\$ 31,04	1,8	±0,08	27,6	±1,0d
3472001	13 x 18	11/2 x 15	952	1	20	R\$ 29,34	2,0	±0,08	41,4	±1,0d
3472101	14 x 15	11/4 x 14	814	1	20	R\$ 29,34	2,2	±0,08	34,5	±1,0d
3472201	14 x 18	11/2 x 14	725	1	20	R\$ 29,34	2,2	±0,08	41,4	±1,0d
3472301	15 x 15	11/4 x 13	690	1	20	R\$ 26,56	2,4	±0,10	34,5	±1,0d
3472401	15 x 18	11/2 x 13	611	1	20	R\$ 26,56	2,4	±0,10	41,4	±1,0d
3472901	15 x 21	2 x 13	513	1	20	R\$ 26,56	2,4	±0,10	48,3	±1,0d
3473001	16 x 18	11/2 x 12	486	1	20	R\$ 25,44	2,7	±0,10	41,4	±1,0d
3473101	16 x 21	2 x 12	397	1	20	R\$ 25,44	2,7	±0,10	48,3	±1,0d
3473201	16 x 24	2 1/4 x 12	345	1	20	R\$ 25,44	2,7	±0,10	55,2	±1,0d
3473301	17 x 21	2 x 11	314	1	20	R\$ 23,84	3,0	±0,10	48,3	±1,0d
3473401	17 x 27	2 1/2 x 11	242	1	20	R\$ 23,84	3,0	±0,10	62,1	±1,0d
3473501	18 x 24	2 1/4 x 10	237	1	20	R\$ 23,10	3,4	±0,10	55,2	±1,0d
3473601	18 x 27	2 1/2 x 10	208	1	20	R\$ 23,10	3,4	±0,10	62,1	±1,0d
3473701	19 x 39	3 1/2 x 9	815	1	20	R\$ 23,10	3,9	±0,10	89,7	±1,0d

PREGO POLIDO CABEÇA DUPLA

AÇO CARBONO



CÓDIGO	TAMANHO		QTD. APROX. DE PREGOS POR KGS	QTD. KGS POR EMB	QTD DE KGS POR CAIXA	PREÇO POR KGS	DIÂMETRO (d)		COMPRIMENTO (L)	
	JP x LPP	POL x BWG					NOMINAL (mm)	TOLERÂNCIA (mm)	NOMINAL (mm)	TOLERÂNCIA (mm)
3473801	17 x 27	2 1/2 x 11	206	1	20	R\$ 30,62	3,0	±0,10	62,1	±1,0d
3473901	18 x 27	2 1/2 x 10	170	1	20	R\$ 30,62	3,4	±0,10	62,1	±1,0d
3474001	18 x 30	2 3/4 x 10	153	1	20	R\$ 30,62	3,4	±0,10	69,0	±1,0d

MATERIAL: AÇO BAIXO CARBONO ACABAMENTO: POLIDO BRILHANTE NCM: 7317.00.90 IPI: 10%



CÓDIGO	TAMANHO		QTD. APROX. DE PREGOS POR KGS	QTD. KGS POR EMB	QTD DE KGS POR CAIXA	PREÇO POR KGS	DIÂMETRO (d)		COMPRIMENTO (L)	
	JP x LPP	POL x BWG					NOMINAL (mm)	TOLERÂNCIA (mm)	NOMINAL (mm)	TOLERÂNCIA (mm)
3474101	12 x 12	-	1.681	1	20	R\$ 41,90	1,8	±0,08	27,6	±1,0d
3474201	13 x 15	11/4 x 15	1.141	1	20	R\$ 39,60	2,0	±0,08	34,5	±1,0d
3474301	13 x 18	11/2 x 15	951	1	20	R\$ 39,60	2,0	±0,08	41,4	±1,0d
3474401	15 x 15	11/4 x 13	777	1	20	R\$ 35,86	2,4	±0,10	30,0	±1,0d
3474501	15 x 18	11/2 x 13	647	1	20	R\$ 35,86	2,4	±0,10	41,4	±1,0d
3474601	15 x 21	2 x 13	555	1	20	R\$ 35,86	2,4	±0,10	48,3	±1,0d
3474701	16 x 11	-	842	1	20	R\$ 35,44	2,7	±0,10	25,3	±1,0d
3474801	16 x 18	11/2 x 12	514	1	20	R\$ 35,44	2,7	±0,10	41,4	±1,0d
3474901	16 x 21	2 x 12	441	1	20	R\$ 35,44	2,7	±0,10	48,3	±1,0d
3475001	16 x 24	2 1/4 x 12	386	1	20	R\$ 35,44	2,7	±0,10	55,2	±1,0d
3475101	16 x 27	2 1/2 x 12	343	1	20	R\$ 35,44	2,7	±0,10	62,1	±1,0d
3475201	17 x 21	2 x 11	334	1	20	R\$ 33,18	3,0	±0,10	48,3	±1,0d
3475301	17 x 27	2 1/2 x 11	290	1	20	R\$ 33,18	3,0	±0,10	62,1	±1,0d
3475401	17 x 30	2 3/4 x 11	261	1	20	R\$ 33,18	3,0	±0,10	69,0	±1,0d
3475501	17 x 33	3 x 11	237	1	20	R\$ 33,18	3,0	±0,10	75,9	±1,0d
3475601	18 x 24	2 1/4 x 10	248	1	20	R\$ 32,85	3,4	±0,10	55,2	±1,0d
3475701	18 x 27	2 1/2 x 10	221	1	20	R\$ 32,85	3,4	±0,10	62,1	±1,0d
3475801	18 x 30	2 3/4 x 10	203	1	20	R\$ 32,85	3,4	±0,10	69,0	±1,0d
3475901	19 x 36	3 1/4 x 9	126	1	20	R\$ 32,85	3,9	±0,10	82,8	±1,0d
3476001	19 x 39	3 1/2 x 9	112	1	20	R\$ 32,85	3,9	±0,10	89,7	±1,0d

PREGO POLIDO ARDOX SEM CABEÇA



CÓDIGO	TAMANHO		QTD. APROX. DE PREGOS POR KGS	QTD. KGS POR EMB	QTD DE KGS POR CAIXA	PREÇO POR KGS	DIÂMETRO (d)		COMPRIMENTO (L)	
	JP x LPP	POL x BWG					NOMINAL (mm)	TOLERÂNCIA (mm)	NOMINAL (mm)	TOLERÂNCIA (mm)
3476101	16 x 18	11/2 x 12	548	1	20	R\$ 35,44	2,7	±0,10	41,4	±1,0d
3476201	16 x 21	2 x 12	461	1	20	R\$ 35,44	2,7	±0,10	48,3	±1,0d
3476301	17 x 21	2 x 11	361	1	20	R\$ 33,18	3,0	±0,10	48,3	±1,0d

MATERIAL: AÇO BAIXO CARBONO
 ACABAMENTO: POLIDO BRILHANTE
 NCM: 7317.00.90
 IPI: 10%



CÓDIGO	TAMANHO		QTD. APROX. DE PREGOS POR KGS	QTD. KGS POR EMB	QTD DE KGS POR CAIXA	PREÇO POR KGS	DIÂMETRO (d)		COMPRIMENTO (L)	
	JP x LPP	POL x BWG					NOMINAL (mm)	TOLERÂNCIA (mm)	NOMINAL (mm)	TOLERÂNCIA (mm)
3476401	12 x 11	-	1.833	0,5	10	R\$ 43,60	1,8	±0,08	25,3	±1,0d
3476501	12 x 12	-	1.681	1	20	R\$ 43,60	1,8	±0,08	27,6	±1,0d
3476601	13 x 15	11/4 x 15	1.141	1	20	R\$ 41,85	2,0	±0,08	34,5	±1,0d
3476701	13 x 18	11/2 x 15	951	1	20	R\$ 41,85	2,0	±0,08	41,4	±1,0d
3476801	15 x 15	11/4 x 13	777	1	20	R\$ 38,40	2,4	±0,10	34,5	±1,0d
3476901	15 x 18	11/2 x 13	647	1	20	R\$ 38,40	2,4	±0,10	41,4	±1,0d
3477001	15 x 21	2 x 13	555	1	20	R\$ 38,40	2,4	±0,10	48,3	±1,0d
3477101	16 x 21	2 x 12	441	1	20	R\$ 38,40	2,7	±0,10	48,3	±1,0d
3477201	16 x 24	2 1/4 x 12	386	1	20	R\$ 38,40	2,7	±0,10	55,2	±1,0d
3477301	17 x 21	2 x 11	334	1	20	R\$ 37,25	3,0	±0,10	48,3	±1,0d
3477401	17 x 27	2 1/2 x 11	290	1	20	R\$ 37,25	3,0	±0,10	62,1	±1,0d
3477501	18 x 27	2 1/2 x 10	221	1	20	R\$ 37,25	3,4	±0,10	62,1	±1,0d
3477601	18 x 30	2 3/4 x 10	203	1	20	R\$ 37,25	3,4	±0,10	69,0	±1,0d
3477701	18 x 36	3 1/4 x 10	166	1	20	R\$ 37,25	3,4	±0,10	82,8	±1,0d

PREGO TELHEIRO GALVANIZADO

COM BORRACHA DE VEDAÇÃO PARA TELHA METÁLICA E FIBROCIMENTO



CÓDIGO	TAMANHO		QTD. APROX. DE PREGOS POR KGS	QTD. KGS POR EMB	QTD DE KGS POR CAIXA	PREÇO POR KGS	DIÂMETRO (d)		COMPRIMENTO (L)	
	JP x LPP	POL x BWG					NOMINAL (mm)	TOLERÂNCIA (mm)	NOMINAL (mm)	TOLERÂNCIA (mm)
3477801	18 x 21	2 x 10	130	0,5	10	SOB CONSULTA	3,4	±0,10	48,3	±1,0d
3477901	18 x 27	2 1/2 x 10	106	0,5	10	SOB CONSULTA	3,4	±0,10	62,1	±1,0d
3478001	18 x 30	2 3/4 x 10	100	0,5	10	SOB CONSULTA	3,4	±0,10	69	±1,0d
3478101	18 x 36	3 1/4 x 10	92	0,5	10	SOB CONSULTA	3,4	±0,10	82,8	±1,0d

MATERIAL: AÇO BAIXO CARBONO

ACABAMENTO: POLIDO BRILHANTE

NCM: 7317.00.90

IPI: 10%

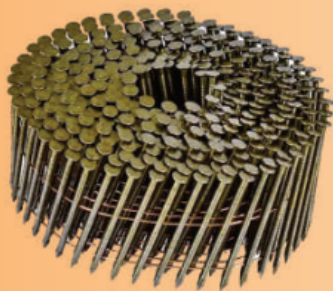

CÓDIGO	MEDIDA (mm)	PREGO POR ROLO	ROLOS POR CAIXA	MILHEIROS POR CAIXA	PREÇO POR ROLO
3478201	2,10x25	350	72	25,20	SOB CONSULTA
3478301	2,10x28	350	66	23,10	
3478401	2,10x30	350	60	21,00	
3478501	2,10x32	350	54	18,90	
3478601	2,10x35	350	48	16,80	
3478701	2,10x38	350	48	16,80	
3478801	2,10x40	350	42	14,70	
3478901	2,10x45	350	36	12,60	
3479001	2,30x35	300	48	14,40	
3479101	2,30x38	300	48	14,40	
3479201	2,30x42	300	42	12,60	
3479301	2,30x45	300	36	10,80	
3479401	2,30x50	300	36	10,80	
3479501	2,30x55	300	30	9,00	
3479601	2,50x38	300	48	14,40	
3479701	2,50x42	300	42	14,40	
3479801	2,50x45	300	36	10,80	
3479901	2,50x50	300	36	10,80	
3480001	2,50x55	300	30	9,00	
3480101	2,50x60	300	30	9,00	
3480201	2,50x65	300	30	9,00	
3480301	2,70x45	250	42	10,50	
3480401	2,70x50	250	36	9,00	
3480501	2,70x55	250	30	7,50	
3480601	2,70x60	250	30	7,50	
3480701	2,70x65	250	24	6,00	
3480801	2,70x70	250	24	6,00	
3480901	2,70x75	250	24	6,00	
3481001	2,70x80	250	24	6,00	
3481101	3,10x65	250	24	6,00	
3481201	3,10x70	250	24	6,00	
3481301	3,10x75	250	24	6,00	
3481401	3,10x80	250	24	6,00	
3481501	3,10x85	250	18	4,50	
3481601	3,10x90	250	18	4,50	

MATERIAL: AÇO BAIXO CARBONO
ACABAMENTO: POLIDO BRILHANTE
NCM: 7317.00.90
IPI: 10%

Polegada	mm	Polegada	mm	Polegada	mm	Polegada	mm
1/64	0,397	21/64	8,334	41/64	16,272	61/64	24,209
1/32	0,794	11/32	8,731	21/32	16,669	31/32	24,606
3/64	1,191	23/64	9,128	43/64	17,066	63/64	25,003
1/16	1,588	3/8	9,525	11/16	17,463	1	25,400
5/64	1,984	25/64	9,922	45/64	17,859	1.1/4	31,750
3/32	2,381	13/32	10,319	23/32	18,256	1.1/2	38,100
7/64	2,778	27/64	10,716	47/64	18,653	1.3/4	44,450
1/8	3,175	7/16	11,113	3/4	19,050	2	50,800
9/64	3,572	29/64	11,509	49/64	19,447	2.1/2	63,500
5/32	3,969	15/32	11,906	25/32	19,844	3	76,200
11/64	4,366	31/64	12,303	51/64	20,241	3.1/2	88,900
3/16	4,763	1/2	12,700	13/16	20,638	4	101,600
13/64	5,159	33/64	13,097	53/64	21,034	4.1/2	114,300
7/32	5,556	17/32	13,494	27/32	21,431	5	127,000
15/64	5,953	35/64	13,891	55/64	21,828	5.1/2	139,700
1/4	6,350	9/16	14,288	7/8	22,225	6	152,400
17/64	6,747	37/64	14,684	57/64	22,622	7	177,800
9/32	7,144	19/32	15,081	29/32	23,019	8	203,200
19/64	7,541	39/64	15,478	59/64	23,416	9	228,600
5/16	7,938	5/8	15,875	15/16	23,813	10	254,000

CABEÇAS

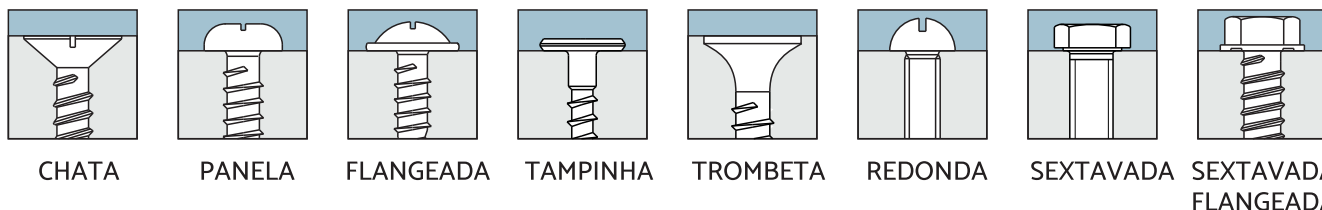

ROSCAS

Medidas polegada	Fios por pol.		Diâmetro da broca
	UNC	UNF	
1/8	40	44	2,5
5/32	32	36	3,1
3/16	24	32	3,6
7/32	24	28	4,4
1/4	20	28	5,1
5/16	18	24	6,5
3/8	16	24	7,9
7/16	14	20	9,2
1/2	13	20	10,5
1/2 WW	12		10,5
9/16	12	18	12,0
5/8	11	18	13,4
3/4	10	16	16,4
7/8	9	14	19,25
1	8	12	22,0

Medidas mm	Passo		Diâmetro da Broca
	MA	MB	
M 3	0,50	0,35	2,5
M 4	0,70	0,50	3,3
M 5	0,80	0,50	4,2
M 6	1,00	0,75	5,0
M 8	1,25	1,00	6,8
M 10	1,50	1,00	8,5
M 12	1,75	1,50	10,2
M 14	2,00	1,50	12,0
M 16	2,00	1,50	14,0
M 18	2,50	1,50	15,5



02	PARAFUSO AUTO-FIX CABEÇA CHATA SIMPLES	35	PARAFUSO TELHA COM & SEM CONJ. VEDAÇÃO
03	PARAFUSO AUTO-FIX CABEÇA CHATA PHILLIPS	36	CHUMBADOR COM PARAFUSO
04	PARAFUSO AUTO-FIX CABEÇA PANELA SIMPLES	36	CHUMBADOR PRISIONEIRO
05	PARAFUSO AUTO-FIX CABEÇA PANELA PHILLIPS	37	CHUMBADOR COM PARAFUSO
06	PARAFUSO AUTO-FIX CABEÇA FLANGEADA PHILLIPS	37	JAQUETA & CONE
06	PARAFUSO PLAST-FIX CABEÇA PANELA SIMPLES	38	PROLONGADOR PARA CHUMBADOR
06	PARAFUSO PLAST-FIX CABEÇA PANELA PHILLIPS	38	SOQUETE IMANTADO
08	PARAFUSO MAQ-FIX CABEÇA CHATA SIMPLES	38	PONTEIRAS
09	PARAFUSO MAQ-FIX CABEÇA REDONDA SIMPLES	39	BUCHAS
10	PARAFUSO MAQ-FIX CABEÇA CHATA PHILLIPS	40	PARAFUSO BROCANTE CHATA PHILLIPS
11	PARAFUSO MAQ-FIX CABEÇA REDONDA PHILLIPS	41	PARAFUSO BROCANTE PANELA PHILLIPS
12	PARAFUSO MAQ-FIX CABEÇA LENTILHA SIMPLES	42	PARAFUSO BROCANTE FLANGEADA PHILLIPS
12	PARAFUSO MAQ-FIX CABEÇA LENTILHA PHILLIPS	42	ARRUELA NEOPRENE
12	PARAFUSO MAQ-FIX CABEÇA LENTILHA TRAVA	43	PARAFUSO BROCANTE SEXTAVADO COM & SEM ARRUELA
13	PARAFUSO SEXTAVADO POLEGADA	44	PARAFUSO DRYWALL FLANGEADA PHILLIPS PONTA AGULHA
14	PARAFUSO SEXTAVADO MÉTRICO	44	PARAFUSO DRYWALL TROMBETA PHILLIPS PONTA AGULHA
15	PORCA SEXTAVADA POLEGADA & MÉTRICA	46	REBITE DE REPUXO ALUMÍNIO NATURAL
15	PORCA BORBOLETA LEVE & PESADA	47	REBITE DE REPUXO ALUMÍNIO NATURAL - ECONÔMICA
16	PORCA TRAVANTE POLEGADA ALTA & BAIXA	48	REBITE DE REPUXO ALUMÍNIO PINTADO EPÓX- CORES
17	PORCA TRAVANTE MÉTRICA ALTA & BAIXA	49	REBITE DE REPUXO ALUMÍNIO PRETO
17	PORCA GARRA	50	REBITE DE REPUXO ALUMÍNIO ABA LARGA
18	PORCA SEXTAVADA FLANGEADA SERRILHADA	51	REBITE DE REPUXO ALUMÍNIO ABA ESCAREADA
18	ARRUELA LISA LEVE POLEGADA & MÉTRICA	52	REBITE DE REPUXO ALUMÍNIO FLORADO
19	ARRUELA DE PRESSÃO POLEGADA & MÉTRICA	53	REBITE DE REPUXO AÇO CARBONO
19	ARRUELA FUNILEIRO	54	REBITE DE REPUXO INOX
20	BARRA ROSCADA POLEGADA & MÉTRICA	55	REBITE DE REPUXO ALUMÍNIO HERMÉTICO
21	PARAFUSO PLAST-FIX CABEÇA FLANGEADA PHILLIPS	56	REBITE DE REPUXO NEW-BOLT
22	PARAFUSO PLAST-FIX CABEÇA PANELA PHILLIPS	56	REBITE DE REPUXO NEW-LOCK
24	PARAFUSO CHIP-FIX CABEÇA CHATA PHILLIPS	57	REBITE SEMI TUBULAR
25	PARAFUSO CHIP-FIX CABEÇA PANELA PHILLIPS	58	REBITE MACIÇO DE ALUMÍNIO
26	PARAFUSO CHIP-FIX CABEÇA FLANGEADA PHILLIPS	59	REBITE MACIÇO DE FERRO
27	PARAFUSO MADE-FIX CABEÇA CHATA SIMPLES	60	REBITE ROSCA INTERNA
28	PARAFUSO MADE-FIX CABEÇA CHATA PHILLIPS	61	REBITADORES
29	PARAFUSO MADE-FIX CABEÇA TAMPINHA PHILLIPS	62	REBITADORES
30	PARAFUSO MÁQUINA LENTILHA COMBINADA	64	PREGO POLIDO COM CABEÇA
30	PARAFUSO ESTRUTURAL ESCAREADO PHILLIPS	65	PREGO POLIDO SEM CABEÇA
30	PARAFUSO ESTRUTURAL ESCAREADO ALLEN	65	PREGO POLIDO CABEÇA DUPLA
31	PARAFUSO ESTRUTURAL TAMPINHA 13 PHILLIPS	66	PREGO POLIDO ARDOX COM CABEÇA
31	PARAFUSO ESTRUTURAL TAMPINHA 13 ALLEN	66	PREGO POLIDO ARDOX SEM CABEÇA
32	PARAFUSO MAQ-FIX TAMPINHA 13 PHILLIPS	67	PREGO POLIDO ANELADO
32	PARAFUSO MAQ-FIX TAMPINHA 13 ALLEN	67	PREGO TELHEIRO GALVANIZADO COM VEDAÇÃO
34	PARAFUSO FRANCÊS COM PORCA	68	PREGO COIL ELETROSOLDADO
35	PARAFUSO SEXTAVADO ROSCA SOBERBA		

DESCONTOS

ACESSE

www.bruen.com.br



**TABELA DE PREÇOS
TAMBÉM DISPONÍVEL NO SITE**

ITENS ESPECIAIS

PRODUZIMOS MEDIANTE AMOSTRA OU DESENHO TÉCNICO,
CONSULTE!



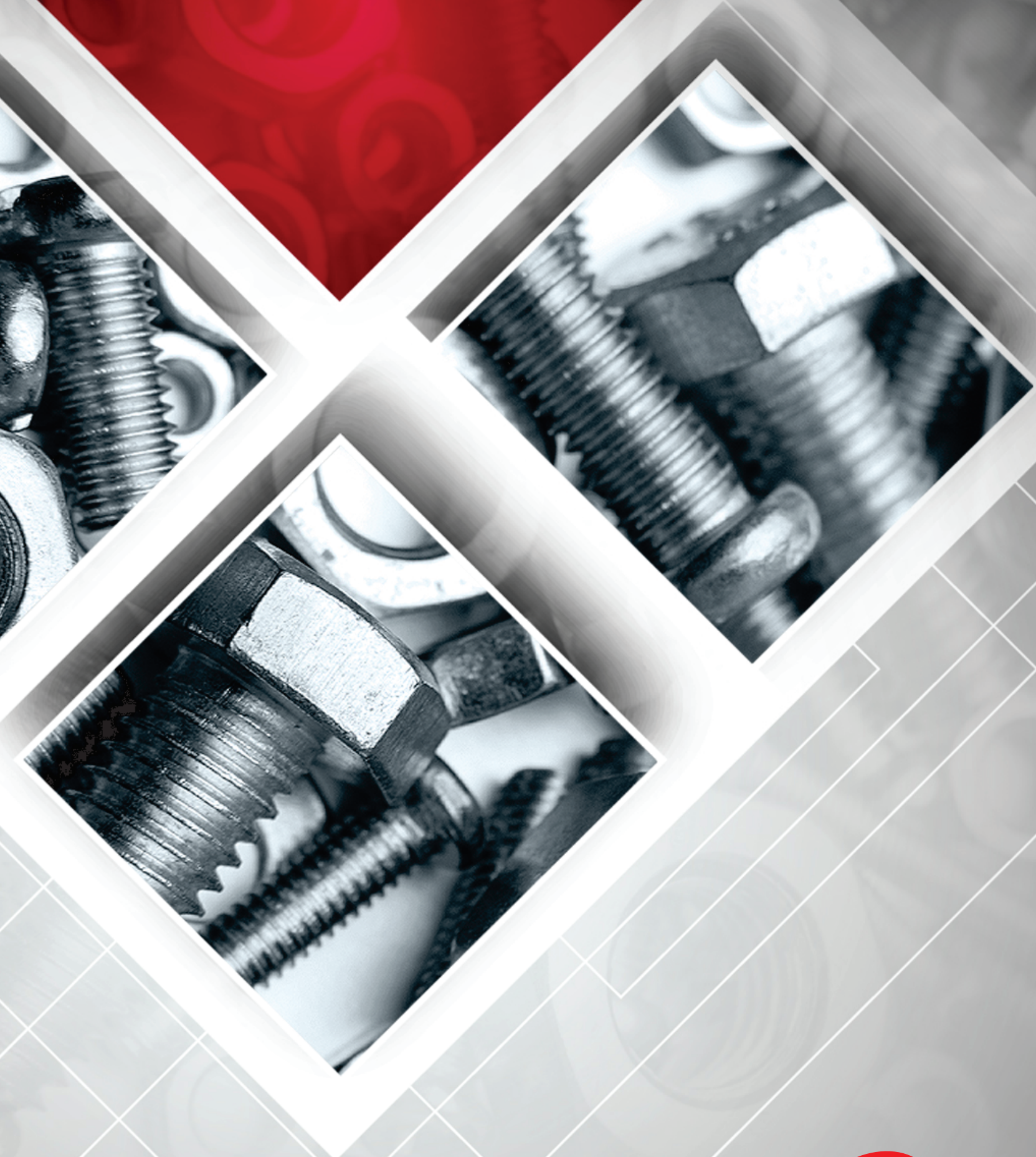

44 **3425-5302 / 99882-9804** 

Rua Projetada A, s/n - Loanda - Paraná

www.bruen.com.br

comercial@bruens.com.br

