

BRUEN

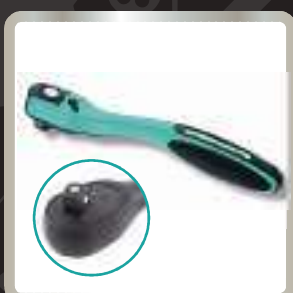

CATÁLOGO



BRUEN



44 **3425-5302 / 99882-9804** 

Rua Projetada A, s/n - Loanda - Paraná

www.bruen.com.br

comercial@bruen.com.br





Um mundo de ferramentas para o seu negócio.

A Toolsworld atende todo o território nacional com uma equipe altamente capacitada e pronta para atender o cliente que procura sempre ferramentas ergonomicamente produzidas e voltadas aos consumidores e profissionais dos mais variados segmentos. A qualidade está presente em todos os nossos produtos espalhados pelo mundo.



A world of instruments for yours business.

Toolsworld serves the entire territory national team with a highly capable and ready to serve the client always looking for tools ergonomically produced and aimed at consumers and segments. Quality is present in all our products all over the world.



Un mundo de instrumentos para el tuyo negocio.

Toolsworld atende todo el territorio nacional con un equipo altamente capacitada y lista para atender al cliente que busca siempre herramientas ergonomicamente producidas y para los consumidores y los profesionales de los más variados segmentos. La calidad está presente en todos los nuestros productos esparcidos por todo el mundo.

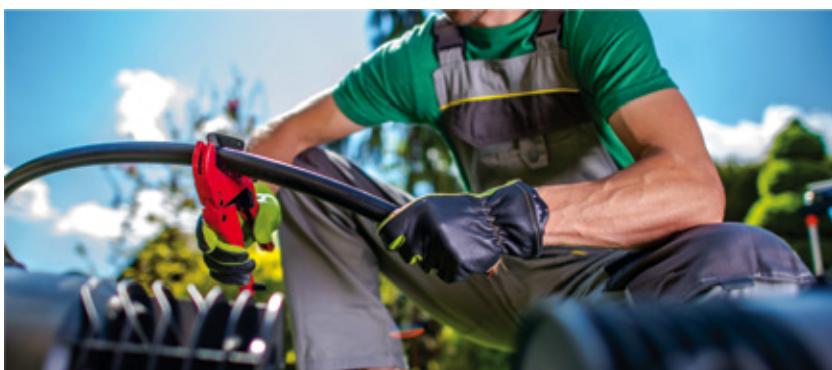
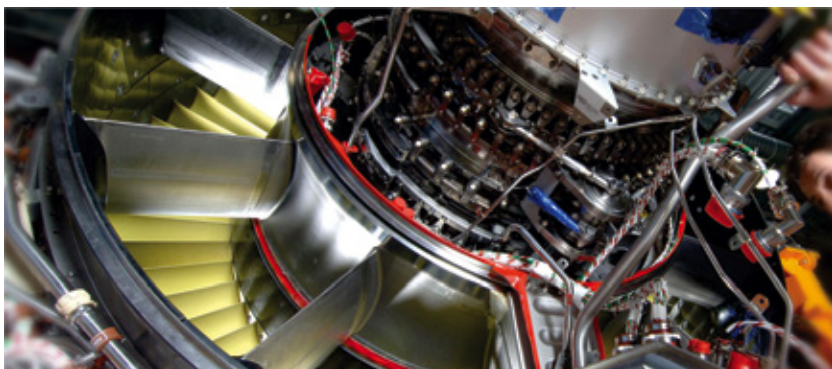

1 FERRAMENTAS DE BANCADA
BENCH TOOLS | HERRAMIENTAS DE BANCADA

PGS 9-64



2 FERRAMENTAS DE CARPINTEIRO
CARPENTER TOOLS | HERRAMIENTAS DE CARPINTERO

PGS 65-72



3 FERRAMENTAS DE MEDIÇÃO
MEASURING TOOLS | HERRAMIENTAS DE MEDICIÓN

PGS 73-84



4 FERRAMENTAS DE MONTAGEM
INSTALLATION TOOLS | HERRAMIENTAS DE MONTAJE

PGS 85-92



5 FERRAMENTAS AUTOMOTIVAS
AUTOMOTIVE TOOLS | HERRAMIENTAS AUTOMOTORES

PGS 93-128



6 FERRAMENTAS DE JARDIM
GARDEN TOOLS | HERRAMIENTAS DE JARDÍN

PGS 129-152



7 FERRAMENTAS DE CORTE
CUTTING TOOLS | HERRAMIENTAS DE CORTE

PGS 153-198



8 FERRAMENTAS CONSTRUÇÃO E ACABAMENTO
CONSTRUCTION AND FINISHING TOOLS
HERRAMIENTAS CONSTRUCCIÓN Y ACABADO

PGS 199-208



9 ACESSÓRIOS DE FERRAMENTAS
TOOL ACCESSORIES
ACCESORIOS DE HERRAMIENTAS

PGS 209-216



INFORMAÇÕES GERAIS
GENERAL INFORMATION
INFORMACIONES GENERALES

PGS 217-232



SUMÁRIO

SUMMARY | RESUMEN

SIMBOLOGIA TÉCNICA

TECHNICAL SYMBOLS | SIMBOLOGÍA TÉCNICA

PRINCIPAL



CÓDIGO
CODE



CARACTERÍSTICAS
Technical Features



PESO CABEÇA
Head Weight
Peso Cabeça



PESO TOTAL
Total Weight



PESO TOTAL
Total Weight
Peso Total



CAIXA MASTER
Box Master | Caja Máster



QUANT. MINÍMA
Quant. Minimum
Cantidad Mínimo



DIÂMETRO
Diameter
Diámetro



PERFIL FENDA
Fenda profile | Perfil fenda



PERFIL PHILLIPS
Profile phillips | Perfil phillips



PERFIL POZIDRIVE
Profile pozidrive | Perfil pozidrive



PERFIL TORX - bit/ponta
Profile TORX - bit/tip
Perfil TORX - bit/punta



PERFIL TORX com guia
Profile TORX with guide
Perfil TORX con guía



PERFIL TORX soquete/encaixe
Profile TORX socket / fitting
Perfil TORX enchufe / encajar



PERFIL SEXTAVADO bit/ponta
Profile Six point bit/tip
Perfil sextavado bit/punta



PERFIL SEXTAVADO soquete/encaixe
Profile Six point socket / fitting
Perfil sextavado enchufe / encaja



PERFIL SEXTAVADO soquete/encaixe
Profile Six point socket / fitting
Perfil sextavado enchufe / encaja



PERFIL SEXTAVADO com guia
Profile Six point with guide
Perfil sextavado con guía



PERFIL BI-SEXTAVADO soquete/encaixe
Profile twelve point socket / fitting
Perfil bi-sextavado enchufe / encaja



PERFIL SPLINE soquete/encaixe
Profile SPLINE socket / fitting
Perfil SPLINE enchufe / encaja



PERFIL SPLINE bit/ponta
Profile SPLINE point bit/tip
Perfil SPLINE bit/punta



PERFIL SPANNER bit/ponta
Profile SPANNER point bit/tip
Perfil SPANNER bit/punta



PERFIL SPAN bit/ponta
Profile SPAN point bit/tip
Perfil SPAN bit/punta



USO PARA FERRAMENTAS PNEUMÁTICAS
Use for pneumatic tools
Uso para herramientas neumáticas



EMBALAGEM TIPO BLISTER
Blister type packaging
Embalaje tipo blister

BLISTER



ENCAIXE SDS MAX
Socket SDS MAX
Encaje SDS MAX



ENCAIXE SDS PLUS
Socket SDS PLUS
Encaje SDS PLUS



ATO CROMO-VANÁDIO
Steel chromo-vanádio | Acero cromado-vanadio



ATO CROMO-MOLIBDÊNIO
Chrome-molybden steel | Acero cromado-molibdenio



ATO S2
S2steel | Acero S2



ATO FORJADO - DUREZA 45HRc
Forged steel - hardness 45hr
Acero forjado - dureza 45hr



ATO CARBONO
Carbon steel
Acero carbono



GRAU DE DUREZA DO AÇO
Strength of steel hardness
Grado de dureza del acero



IMÃ MINEDIN
Magnet minedin
Imán minedin



PARA TRABALHOS EM ÁREAS COM VOLTAGEM DE ATÉ 1000V
For work in areas with voltage up to 1000V
Para trabajos en áreas con voltagen de hasta 1000V



PADRÃO INTERNACIONAL DE SEGURANÇA PARA PRODUTOS ELETRO-ELETRÔNICOS

International standard of safety for electronic-electronic products

Estándar internacional de seguridad para productos electrón-electrónicoS



NORMA INTERNACIONAL IEC 60900:2004 PARA PRODUTOS ELETRO-ELETRÔNICOS

International standard iec 60900: 2004 For electronic-electronic products

Norma internacional iec 60900: 2004 Para productos electrón-electrónicoS



NORMA INSTITUTO ALEMÃO PARA NORMALIZAÇÃO

O uso da norma DIN, bem como de outras normas internacionais, assegura um padrão de qualidade na fabricação de produtos e equipamentos, refletindo diretamente na segurança do consumidor final.

GERMAN INSTITUTE FOR NORMALIZATION The use of the DIN standard, as well as other international standards, ensures a quality standard in the manufacture of products and equipment, directly reflecting the safety of the final consumer.

INSTITUTO ALEMÁN PARA NORMALIZACIÓN El uso de la norma DIN, así como de otras normas internacionales, asegura un estándar de calidad en la fabricación de productos y equipos, reflejando directamente en la seguridad del consumidor final.

BANCADA

BENCH | BANCADA

FERRAMENTAS DE BANCADA

BENCH'S TOOLS
HERRAMIENTAS DE BANCADA

As ferramentas de bancada GROSS, MTX e SPARTA, proporcionam ao profissional ou consumidor final um produto de extrema eficiência para o trabalho a ser desenvolvido. Utilizando matérias primas de qualidade as ferramentas tem um ótimo desempenho e proporcionam um excelente resultado.

The GROSS, MTX and SPARTA benchtop tools provide the professional or final consumer with an extremely efficient product for the work to be done. Using quality raw materials the tools have a great performance and provide an excellent result.

Las herramientas de banco GROSS, MTX y SPARTA, proporcionan al profesional o consumidor final un producto de extrema eficiencia para el trabajo a ser desarrollado. Utilizando materias primas de calidad las herramientas tienen un óptimo desempeño y proporcionan un excelente resultado.

SIMBOLOGIA



CÓDIGO
CODE



CARACTERÍSTICAS
Technical Features



PESO CABEÇA
Head Weight
Peso Cabeza



PESO TOTAL
Total Weight



PESO DA PEÇA
Part Weight
Peso de la Pieza



CAIXA MASTER
Box Master | Caja Máster



QUANT. MINÍMA
Quant. Minimum
Cantidad Mínimo



DIÂMETRO
Diameter
Diámetro



Martelo bola c/ cabo de madeira polida

Ball hammer with polished wood handle | Martillo bola con mango de madera pulida



AÇO FORJADO 45Hrc



	KG	KG	DIMENSÕES SIZE TAMAÑO (MM)			Quant. Min.	
			A	B	C		
1020055	200g	330g	80	285	20	60	6
1020155	300g	430g	95	300	25	48	6
1020255	400g	580g	100	320	25	24	6
1020355	600g	830g	110	350	30	48	6
1020455	800g	1040g	125	360	30	36	6
1020555	1000g	1290g	130	380	40	24	6

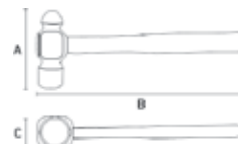

- Extremidades lixadas | Sanded ends | Extremos lijados
- Cabeça envernizada | Varnished head | Cabeza barnizada

Martelo bola c/ cabo emborrachado

Ball hammer with rubber cable | Martillo bola con mango de goma



AÇO FORJADO 55Hrc

NORMA DIN 1041



	KG	KG	DIMENSÕES SIZE TAMAÑO (MM)			Quant. Min.	
			A	B	C		
1020955	200g	361g	80	285	20	48	6
1021055	300g	467g	90	310	25	36	6
1021155	400g	604g	100	360	25	24	6
1020755	600g	889g	110	310	30	24	6
1020855	800g	1083g	130	350	30	12	6
1020655	1000g	1375g	135	390	40	12	6

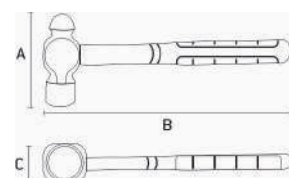

- Extremidades lixadas | Sanded ends | Extremos lijados
- Cabeça envernizada | Varnished head | Cabeza barnizada
- Cabo de fibra de alta resistência com empunhadura de borracha | High-strength fiber cable with rubber grip | Mango de fibra de alta resistencia con empuñadura de goma

Martelo pena cabo de madeira

Machinist's hammer wooden handle | Martillo de pena con mango de madera



AÇO FORJADO 45Hrc



	antigo	novo	KG	KG	DIMENSÕES SIZE TAMAÑO (MM)			Quant. Min.
					A	B	C	
102025	1020256	100g	169g	80	260	20	120	12
102045	1020456	200g	283g	90	280	20	60	12
102065	1020656	300g	394g	103	300	23	48	6
102085	1020856	400g	512g	110	310	30	48	6

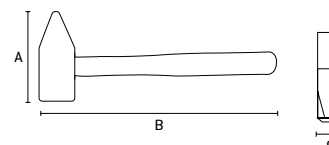

- Cabeça forjada em aço especial. | Forged special steel head | Cabeza forjada en acero especial
- Têmpera na face de impacto e na pena. | Hardened on the striking face and pein | Temple en la base de impacto y en la pena.
- Cabeça com pintura eletrostática. | Head with electrostatic paint finishing | Cabeza con pintura electrostática.
- Fixação por cunha metálica. | Fixed with steel wedge | Fijación con cuña metálica.
- Cabo de madeira envernizado. | Varnished hardwood handle | Mango de madera barnizado

Martelo pena cabo de madeira pintado

Machinist's hammer painted wood cable | Martillo de pena mango de madera pintada



AÇO FORJADO 55Hrc

NORMA DIN 1041



	KG	KG	DIMENSÕES SIZE TAMAÑO (MM)			Quant. Min.	
			A	B	C		
102279	200g	278g	94	283	20	72	12
102289	300g	690g	104	304	23	48	6
102309	400g	533g	111	313	25	36	6
102339	600g	828g	121	323	30	24	6*

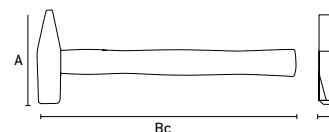

- Têmpera na face de impacto e na pena. | Hardened on the striking face and pein. | Temple en la base de impacto y en la pena
- Cabeça com pintura eletrostática. | Head with electrostatic paint finishing | Cabeza con pintura electrostática.
- Cabo de madeira longo envernizado com desenho anatômico para a diminuição de vibração. | Long varnished wood handle with anatomical design for the decrease of vibration. | Mango de madeira largo barnizado con un diseño anatómico para disminución de la vibración.

Martelo Unha Tubular com cabo emborrachado

Tubular Nail Hammer with Rubberized Cable |
Martillo Uña Tubular con Mango de goma

AÇO FORJADO 45HRc



AÇO CARBONO



antigo	novo	Ø	KG	KG	DIMENSÕES SIZE TAMAÑO (MM)		Quant. Min.
					A	B	
	1044035	23	285g	380g	100	240	6
	1044045	25	345g	460g	110	290	6
104405	1044055	27	479g	639g	120	310	6

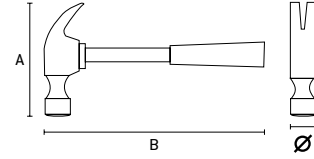

- Cabeça envernizada | Varnished head | Cabeza barnizada
- Cabo de Metal e emborrachado | Rubberized metal cable | Mango de metal y de goma

Martelo unha cabo de madeira

Claw hammer wooden handle |
Martillo uña mango de madera



AÇO FORJADO 45HRc



antigo	novo	Ø	KG	KG	DIMENSÕES SIZE TAMAÑO (MM)		Quant. Min.
					A	B	
	104104	20	247g	330g	100	299	26
	104105	23	248g	340g	105	300	26
	104106	25	375g	500g	127	320	26
	104205	27	467g	622g	130	325	26
	104206	29	563g	750g	140	345	26

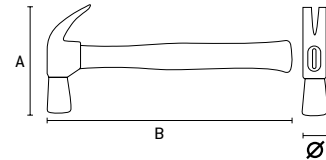

- Cabo de madeira envernizada | Varnished wood cable | Mango de madeira barnizada
- Desenho anatômico para diminuir vibração | Anatomical design to decrease vibration | Diseño anatómico para disminuir la vibración
- Cabeça polida | Polished head | Cabeza pulida

Martelo unha Cabo de fibra

Claw hammer Fiber cable | Martillo uña mango de fibra



AÇO FORJADO 55HRc



antigo	Ø	KG	KG	DIMENSÕES SIZE TAMAÑO (MM)		Quant. Min.
				A	B	
	20	260g	347g	100	275	6
	23	329g	438g	120	300	6
	25	396g	528g	130	325	6
	27	479g	639g	135	330	6
	29	594g	792g	140	335	6

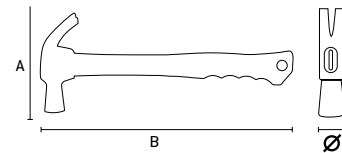

- Cabeça polida | Polished head | Cabeza pulida
- Cabo em fibra de alta resistência | High strength fiber cable | Mango de fibra de alta resistencia
- Empunhadura em borracha termoplástica | Thermoplastic rubber grip | Empuñadura de caucho termoplástico

Martelo unha Cabeça Imantada

Claw Hammer Head Magnet | Martelo unha Cabeça imã



AÇO FORJADO 55HRc



antigo	Ø	KG	KG	DIMENSÕES SIZE TAMAÑO (MM)		Quant. Min.
				A	B	
	27	554g	738g	132	330	6

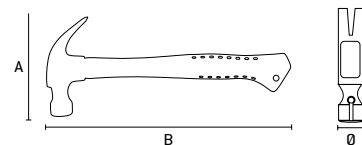

- Cabeça polida | Polished head | Cabeza pulida
- Cabo em fibra de alta resistência | High strength fiber cable | Cable de fibra de alta resistencia
- Empunhadura em borracha termoplástica | Thermoplastic rubber grip | Empuñadura de caucho termoplástico

Encaixe imantado para apoio de pregos com cabeça
Magnetic fitting for nail head support
Enganche imantado para apoyo de clavos con cabeza



Martelo Unha

Claw Hammer | Martelo unha



				DIMENSÕES SIZE TAMAÑO (MM)				
104509	27	450g	554g	A	B	36	6*	

AÇO FORJADO 55HRc

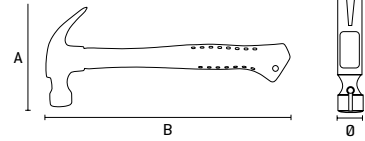

- Cabeça polida | Polished head | Cabeza pulida
- Cabo em fibra de alta resistência | High strength fiber cable | Cable de fibra de alta resistencia
- Empunhadura em borracha termoplástica | Thermoplastic rubber grip | Empuñadura de caucho termoplástico

Marreta Quadrada

Square Mallet | Mazza cuadrado



				DIMENSÕES SIZE TAMAÑO (MM)				
antigo	novo	KG	KG	A	B	Ø	Quant. Min.	
10905	1090556	1000g	1167g	100	280	30	24	6
10907	1090756	1500g	1667g	110	300	40	12	6
10909	1090956	2000g	2244g	117	320	50	12	6

AÇO FORJADO 55HRc

NORMA DIN 6475

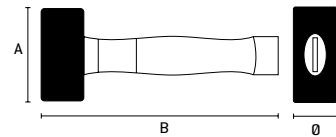

- Cabeça Quadrada | Square head | Cabeza Cuadrada
- Cabo de madeira envernizado | Varnished wood handle | Mango de madera barnizada

Marreta oitavada

Octave hammer | Mazza octava



			DIMENSÕES SIZE TAMAÑO (MM)				
	KG	KG	A	B	Ø	Quant. Min.	
1090155	500 g	518g	80	310	30	36	6
1090555	1000g	1080g	100	330	35	24	6
1090755	1500g	1562g	120	350	40	12	6
1090955	2000g	2100g	130	400	45	12	6
1090655	3000g	3330g	150	605	55	6	1
1090855	5000g	6000g	180	900	60	4	1
1092555	8000g	9500g	200	900	75	6	1

AÇO FORJADO 55HRc

NORMA DIN 6475

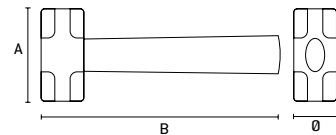

- Cabeça Oitavada | Square head | Cabeza Cuadrada
- Cabo de madeira envernizado | Wood handle varnished | Mango de madera vidriado

Marreta oitavada cabo em fibra

Octave hammer with fiber cable | Marreta octava con mango de fibra



			DIMENSÕES SIZE TAMAÑO (MM)				
	KG	KG	A	B	Ø	Quant. Min.	
1092655	500g	694g	75	300	30	36	6
1091955	1000g	1208g	100	320	35	24	6
1092055	1500g	1583g	110	370	40	24	6
1092155	2000g	2083g	120	375	50	12	6
1092255	3000g	3833g	150	380	55	6	1

AÇO FORJADO 55HRc

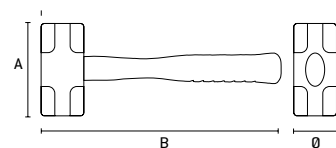

- Cabeça Oitavada | Eighth Head | Cabeza octava
- Cabo em fibra de alta resistência para reduzir o impacto e a vibração transmitidos ao usuário | High strength fiber cable to reduce impact and vibration transmitted to the user | Mango de fibra de alta resistencia para reducir el impacto y la vibración transmitidos al usuario

Marreta Quadrada Cabo de fibra

Square Hammer Fiber Cable |
Marreta cuadrado con mango de fibra



Barcode	Ø	KG	KG	DIMENSÕES SIZE TAMAÑO (MM)		Quant. Min.
				A	B	
109229	58	3000g	3938g	140	910	4
109249	70	5000g	5938g	160	910	4

AÇO FORJADO 52HRc

NORMA DIN 6475

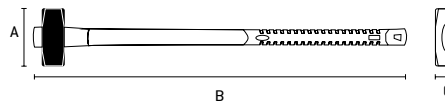

- Aço forjado | Forged steel | Acero forjado
- Cabo em fibra de alta resistência | High strength fiber cable | Mango de fibra de alta resistencia
- Norma DIN 6475 | Standard DIN 6475 | Norma DIN 6475

Martelo Poliuretano anti-retorno

Anti-return polyurethane hammer | Martillo Poliuretano anti-retorno



Barcode	Ø	KG	KG	DIMENSÕES SIZE TAMAÑO (MM)		Quant. Min.
				A	B	
1098555	40	708g		80	290	36
1098655	50	917g		110	340	24
1098755	60	1000g		120	375	12

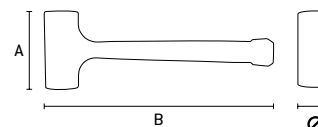

- Anti - retorno | Anti - return | Anti - retorno
- Todo em Poliuretano | All in Polyurethane | Todo en Poliuretano
- Ideal para montagens industriais, martelinho de ouro e funilarias em geral | Ideal for industrial assemblies, gold hammer and funillars in general | Ideal para montajes industriales, martillos de oro y funerales en general

104404

Martelo de borracha cabo de madeira

Rubber hammer with wooden handle |
Martillo de goma con mango de madera



antigo	novo	Ø	KG	KG	DIMENSÕES SIZE TAMAÑO (MM)		Quant. Min.
					A	B	
111305	1113055	30	225g	305g	80	260	60
111405	1114055	40	340g	469g	90	280	48
	1115055	50	450g	567g	100	320	36
111555	1115555	60	680g	846g	110	360	24

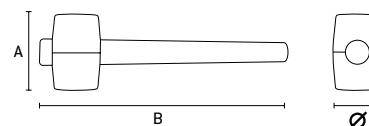

- Cabeça de Borracha | Rubber Head | Cabeza de Goma
- Cabo de madeira pintado e envernizado | Painted wood handle and varnished | Mango de madeira pintado y barnizado

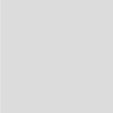

Martelo de borracha Preto e Branco

Black and White Rubber Hammer | Martillo de goma Blanco y negro



Barcode	Ø	KG	DIMENSÕES SIZE TAMAÑO (MM)		Box	Quant. Min.
			A	B		
111709	50	450g	78	287	36	6
111719	60	758g	95	318	24	6
111729	70	1000g	115	342	24	6

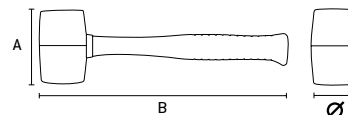

Aplicação: parte branca para porcelanato (não deixa resíduos) e parte preta para cerâmica

Application: white part for porcelain (leaves no residue) and black part for ceramics

Aplicación: parte blanca para porcelanato (no deja residuos) parte negra para la cerámica

- Cabo de fibra com revestimento em borracha termoplástica | Fiber cable with coating in thermoplastic rubber | Mango de fibra con revestimiento de caucho termoplástico



Martelo de borracha p/ Cerâmica

Ceramic Rubber Hammer | Martillo de goma Cerámica



Barcode	Ø	KG	DIMENSÕES SIZE TAMAÑO (MM)		Box	Quant. Min.
			A	B		
111759	50	422g	76	287	36	6
111859	60	742g	96	318	24	6
111939	70	967g	116	342	24	6

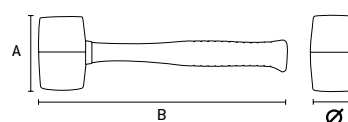

Aplicação: Pisos de Cerâmica

Application: Ceramic floors

Aplicación: Pisos de Cerámica

- Cabeça de Borracha Preto | Black Rubber Head | Cabeza de caucho negro
- Cabo de fibra com revestimento em borracha termoplástica | Fiber cable with coating in thermoplastic rubber | Mango de fibra con revestimiento de caucho termoplástico



Martelo de borracha p/ Porcelanato

Rubber Hammer Porcelain | Martillo de goma Porcelanato



Barcode	Ø	KG	DIMENSÕES SIZE TAMAÑO (MM)		Box	Quant. Min.
			A	B		
111959	50	414g	76	287	36	6
111969	60	742g	95	318	24	6
111979	70	963g	115	342	24	6

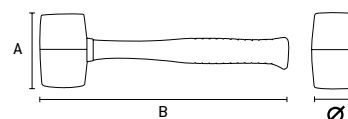

Aplicação: Pisos de porcelanato (não deixa resíduos)

Application: Porcelain flooring (leaves no residue)

Aplicación: Pisos de porcelanato (no deja residuos)

- Cabeça de Borracha Branca | White Rubber Head | Cabeza de caucho Blanco
- Cabo de fibra com revestimento em borracha termoplástica | Fiber cable with coating in thermoplastic rubber | Mango de fibra con revestimiento de caucho termoplástico



Chaves Allen Curta fosfatizada

Allen Key Phosphatized | Chaves Allen fosfatizado



• Acabamento Fosfatizado | Phosphated Finish | Acabado Fosfatizado

Código	Tamanho	DIMENSÕES SIZE TAMAÑO (MM)			Quant. Min.	
		A	B	C		
1120155	1,5 mm - 25 pçs	13	44	1,5	250	25
1120255	2,0 mm - 25 pçs	15	50	2	250	25
1120355	2,5 mm - 25 pçs	18	56	2,5	250	25
1120455	3,0 mm - 25 pçs	22	65	3	250	25
1120555	4,0 mm - 20 pçs	27	72	4	200	20
1122555	5,0 mm - 20 pçs	32	80	5	200	20
1121255	6,0 mm - 20 pçs	37	90	6	200	20
1121455	7,0 mm - 20 pçs	39	101	7	200	20
1121655	8,0 mm - 10 pçs	43	108	8	100	10
1122855	9,0 mm - 10 pçs	45	117	9	100	10
1123055	10,0 mm - 10 pçs	50	123	10	100	10
1123255	12,0 mm - 10 pçs	55	133	12	100	10

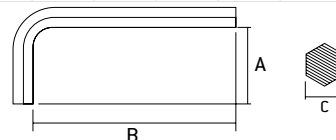

Chaves Allen Longa Abaulada fosfatizada

Allen Key Long Phosphatized | Chaves Allen Larga fosfatizado



• Acabamento Fosfatizado | Phosphated Finish | Acabado Fosfatizado

Código	Tamanho	DIMENSÕES SIZE TAMAÑO (MM)			Quant. Min.	
		A	B	C		
1125655	1,5 mm - 25 pçs	13	70	1,5	250	25
1125755	2,0 mm - 25 pçs	15	77	2	250	25
1125855	2,5 mm - 25 pçs	18	86	2,5	250	25
1125955	3,0 mm - 25 pçs	22	102	3	250	25
1126055	4,0 mm - 20 pçs	27	109	4	200	20
1126155	5,0 mm - 20 pçs	32	123	5	200	20
1126255	6,0 mm - 20 pçs	37	135	6	200	20
1126355	7,0 mm - 20 pçs	39	147	7	200	20
1126455	8,0 mm - 10 pçs	43	157	8	100	10
1126555	9,0 mm - 10 pçs	45	167	9	100	10
1126855	10,0 mm - 10 pçs	50	177	10	100	10
1126755	12,0 mm - 10 pçs	55	187	12	100	10

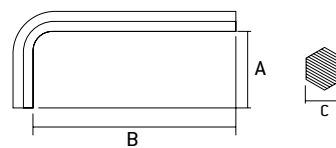

Chaves TORX curta fosfatizado com guia

TORX Key Phosphatized | Chaves TORX fosfatizado



• Acabamento Fosfatizado | Phosphated Finish | Acabado Fosfatizado

Código	Tamanho	DIMENSÕES SIZE TAMAÑO (MM)			Quant. Min.	
		A	B	C		
1127555	T10 - 25 pçs	13	54	15	250	25
1127655	T15 - 25 pçs	15	61	20	250	25
1127755	T20 - 25 pçs	18	66	30	250	25
1127855	T25 - 25 pçs	25	73	35	250	25
1127955	T27 - 10 pçs	29	81	40	100	10
1128055	T30 - 10 pçs	32	90	45	100	10
1128155	T40 - 10 pçs	35	100	50	100	10
1128255	T45 - 5 pçs	43	110	60	100	5
1128355	T50 - 5 pçs	45	127	70	100	5

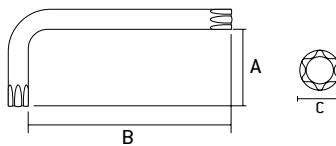

Chaves Torx Longa fosfatizada com guia

Allen Key Phosphatized | Chaves Allen fosfatizado



• Acabamento Fosfatizado | Phosphated Finish | Acabado Fosfatizado

Código	Tamanho	DIMENSÕES SIZE TAMAÑO (MM)			Quant. Min.	
		A	B	C		
1128755	T10 - 25 pçs	13	70	15	250	25
1128855	T15 - 25 pçs	15	77	20	250	25
1128955	T20 - 25 pçs	18	86	30	250	25
1129055	T25 - 25 pçs	25	93	35	250	25
1129155	T27 - 10 pçs	29	109	40	100	10
1129255	T30 - 10 pçs	32	123	45	100	10
1129355	T40 - 10 pçs	35	139	50	100	10
1129455	T45 - 5 pçs	43	155	60	100	5
1129555	T50 - 5 pçs	45	173	70	100	5

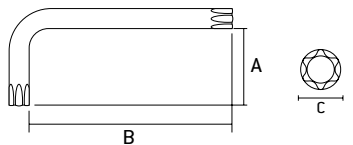

Jogos de Chaves Torx de 9 peças

Torx key set - 9 peices | Juegos de Chaves Torx de 9 piezas



9
peças
parts | piezas

SKU	CHAVE CORRESPONDENTE	KG	A	B
123059	T10 T15 T20 T25 T27 T30 T40 T45 T50 - curta	48	12	12
123069	T10 T15 T20 T25 T27 T30 T40 T45 T50 - longa	36	12	12
123079	TR T10 T15 T20 T25 T27 T30 T40 T45 T50 - extra longa	36	12	12

123059 - Curta

CHAVE CORRESPONDENTE	KG	A	B
T10	1g	13	44
T15	2g	15	48
T20	4g	18	56
T25	5g	20	63
T27	10g	24	70
T30	18g	27	80
T40	28g	31	90
T45	58g	35	100
T50	102g	40	112

123069 - Longa

CHAVE CORRESPONDENTE	KG	A	B
T10	1,4g	13	63
T15	2g	15	77
T20	4g	18	87
T25	7g	20	93
T27	14g	24	104
T30	25g	27	120
T40	41g	31	141
T45	84g	35	158
T50	145g	40	180

123079 - Extra Longa

CHAVE CORRESPONDENTE	KG	A	B
T10	1,6g	13	91
T15	3,2g	15	102
T20	5,6g	18	114
T25	9,1g	20	129
T27	18,2g	24	144
T30	32,5g	27	165
T40	53,2g	31	188
T45	104,9g	35	208
T50	183,6g	40	234

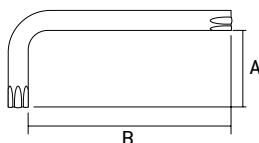

• Acabamento acetinado | Satin finish | Acabado santinado

Jogo de Chaves Allen de 9 peças fosfatizado

Allen Key Set - 9 peices Phosphatized | Juego de Chaves Allen de 9 piezas fosfatizado



112269

• Série curta | Short serie | Serie corta

CHAVE CORRESPONDENTE	KG	A	B
1,5	1g	13	44
2	2g	15	48
2,5	4g	18	56
3	5g	20	63
4	10g	24	70
5	18g	27	80
6	28g	31	90
8	58g	35	100
10	102g	40	112

9
peças
parts | piezas



SKU	CHAVE CORRESPONDENTE	KG	A	B
112269	1,5 2,0 2,5 3,0 4,0 5,0 6,0 8,0 10,0 mm - Curta	72	12	12
112319	1,5 2,0 2,5 3,0 4,0 5,0 6,0 8,0 10,0 mm - Longa	36	12	6

112319

• Série longa | Long serie | Serie Larga

CHAVE CORRESPONDENTE	KG	A	B
1,5	1,4 g	15	63
2	2 g	18	77
2,5	4 g	20	87
3	7 g	23	93
4	14 g	29	104
5	25 g	33	120
6	41 g	38	141
8	84 g	44	158
10	145 g	50	180

• Acabamento Fosfatizado | Phosphated Finish | Acabado Fosfatizado

Jogos de Chaves Allen de 9 peças Torx key set - 9 peices | Juegos de Chaves Torx de 9 piezas



112339	1,5 2,0 2,5 3,0 4,0 5,0 6,0 8,0 10,0 mm - Longa	36	6
164109	1,5 2,0 2,5 3,0 4,0 5,0 6,0 8,0 10,0 mm - Extra-longa	36	12
164119	2,0 2,5 3,0 4,0 5,0 6,0 8,0 10,0 12,0 mm - Extra-longa	36	12



112339 • Série longa | Long serie | Serie larga

CHAVE CORRESPONDENTE CORRESPONDING KEY CLAVE CORRESPONDENTE	KG	DIMENSÕES SIZE TAMAÑO (MM)	
		A	B
1.5	1 g	13	63
2	2 g	15	77
2.5	4 g	18	87
3	5 g	20	93
4	10 g	24	104
5	18 g	27	120
6	28 g	31	141
8	102 g	35	158
10	120 g	40	180



Permite trabalhar com um ângulo de até 25° em relação ao eixo do parafuso.
This key allows you to work on screws situated up to 25° from the vertical.
Permite trabajar con un ángulo de hasta 25° con relación al eje del tornillo.



164109 • Série extra longa | Extra long serie Serie extra larga

CHAVE CORRESPONDENTE CORRESPONDING KEY CLAVE CORRESPONDENTE	KG	DIMENSÕES SIZE TAMAÑO (MM)	
		A	B
1,5	1,6 g	15	91
2,0	3,2 g	18	102
2,5	5,6 g	20	114
3,0	9,1 g	23	129
4,0	18,2 g	29	144
5,0	32,5 g	33	165
6,0	53,2 g	38	188
8,0	104,9 g	44	208
10,0	183,6 g	50	234

164119 • Série extra longa | Extra long serie Serie extra larga

CHAVE CORRESPONDENTE CORRESPONDING KEY CLAVE CORRESPONDENTE	KG	DIMENSÕES SIZE TAMAÑO (MM)	
		A	B
2,0	3,2 g	18	102
2,5	5,6 g	20	114
3,0	9,1 g	23	129
4,0	18,2 g	29	144
5,0	32,5 g	33	165
6,0	53,2 g	38	188
8,0	104,9 g	44	208
10,0	183,6 g	50	234
12,0	260 g	55	259

• Acabamento acetinado | Satin Finish | Acabado santinado



Jogo de Chaves Allen de 9 peças acetinado

Satin Allen key set - 9 peices | Juego de Chaves Allen de 9 piezas satinado



CrV
Alta
Qualidade



BLISTER



123019

• Série curta | Short series | Serie corta

CHAVE CORRESPONDENTE CORRESPONDING KEY CLAVE CORRESPONDENTE	KG	DIMENSÕES SIZE TAMAÑO (MM)	
		A	B
2,0	2g	15	48
2,5	4g	18	56
3,0	5g	20	63
4,0	10g	24	70
5,0	18g	27	80
6,0	28g	31	90
8,0	58g	35	100
10,0	102g	40	112
12,0	120g	45	120

123039

• Série curta | Short series | Serie corta

CHAVE CORRESPONDENTE CORRESPONDING KEY CLAVE CORRESPONDENTE	KG	DIMENSÕES SIZE TAMAÑO (MM)	
		A	B
1,5	1g	13	44
2,0	2g	15	48
2,5	4g	18	56
3,0	5g	20	63
4,0	10g	24	70
5,0	18g	27	80
6,0	28g	31	90
8,0	58g	35	100
10,0	102g	40	112

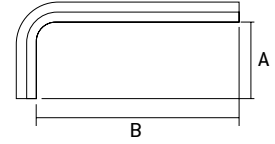

123049

• Série longa | Long serie | Serie larga

CHAVE CORRESPONDENTE CORRESPONDING KEY CLAVE CORRESPONDENTE	KG	DIMENSÕES SIZE TAMAÑO (MM)	
		A	B
1,5	1,4g	13	63
2,0	2g	15	77
2,5	4g	18	87
3,0	7g	20	93
4,0	14g	24	104
5,0	25g	27	120
6,0	41g	31	141
8,0	84g	35	158
10,0	145g	40	180

123029

• Série longa | Long serie | Serie larga

CHAVE CORRESPONDENTE CORRESPONDING KEY CLAVE CORRESPONDENTE	KG	DIMENSÕES SIZE TAMAÑO (MM)	
		A	B
2,0	2g	15	77
2,5	4g	18	87
3,0	7g	20	93
4,0	14g	24	104
5,0	25g	27	120
6,0	41g	31	141
8,0	84g	35	158
10,0	145g	40	180
12,0	228g	55	205

• Acabamento acetinado | Satin Finish | Acabado santinado



9
peças
parts | piezas

164099
• Série extra longa | Extra long serie |
Serie extra larga

CHAVE CORRESPONDENTE CORRESPONDING KEY CLAVE CORRESPONDENTE	KG	DIMENSÕES SIZE TAMAÑO (MM)	
		A	B
1,5	1,6g	13	91
2,0	3,2g	15	102
2,5	5,6g	18	114
3,0	9,1g	20	129
4,0	18,2g	24	144
5,0	32,5g	27	165
6,0	53,2g	31	188
8,0	104,9g	35	208
10,0	183,6g	40	234

123089
• Série extra longa | Extra long serie |
Serie extra larga

CHAVE CORRESPONDENTE CORRESPONDING KEY CLAVE CORRESPONDENTE	KG	DIMENSÕES SIZE TAMAÑO (MM)	
		A	B
2,0	3,2g	15	102
2,5	5,6g	18	114
3,0	9,1g	20	129
4,0	18,2g	24	144
5,0	32,5g	27	165
6,0	53,2g	31	188
8,0	104,9g	35	208
10,0	183,6g	40	234
12,0	260g	55	259

Jogos de Chaves Allen / Torx Argola

Allen / Torx key set Ring | Juegos de Llaves Allen / Torx Anillo

antigo	novo					
112665	1126655	1,5 2,0 2,5 3,0 3,5 4,0 5,0 6,0 8,0 10,0 mm - HEX	100	20		
112667	1126675	T10 T15 T20 T25 T27 T30 T40 T45 T50 - TORX	100	20		

- HEX
- TR
- SACO PLÁSTICO
- AUTO SERVIÇO



112665 / 1126655
• Série curta | Shoet serie | Serie corte

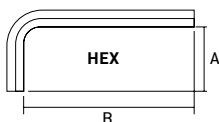

10
peças
parts | piezas

CHAVE CORRESPONDENTE CORRESPONDING KEY CLAVE CORRESPONDENTE	KG	DIMENSÕES SIZE TAMAÑO (MM)	
		A	B
1,5	1g	12	37
2	2g	13	40
2,5	3g	14	42
3	4g	14	47
3,5	6g	15	48
4	8g	16	53
5	12g	17	57
6	20g	18	60
8	38g	19	62
10	68g	23	72

112667 / 1126675
• Série curta | Shoet serie | Serie corte

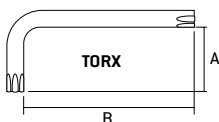

9
peças
parts | piezas

CHAVE CORRESPONDENTE CORRESPONDING KEY CLAVE CORRESPONDENTE	KG	DIMENSÕES SIZE TAMAÑO (MM)	
		A	B
T10	1g	13	44
T15	2g	15	48
T20	4g	18	56
T25	5g	20	63
T27	10g	24	70
T30	18g	27	80
T40	28g	31	90
T45	58g	35	100
T50	102g	40	112

•Acabamento Fosfatizado | Phosphated Finish | Acabado Fosfatizado

Estojo de Chaves Allen HEX/Torx de 18 peças

Allen HEX/Torx key case - 18 peices | Estuche de Llaves Allen HEX/Torx de 18 piezas



18
peças
parts | piezas



123149

CHAVE CORRESPONDENTE CORRESPONDING KEY CLAVE CORRESPONDENTE	KG	DIMENSÕES SIZE TAMAÑO (MM)	
		A	B
1,5	1g	12	37
2	2g	13	40
2,5	3g	14	42
3	4g	14	47
3,5	6g	15	48
4	8g	16	53
5	12g	17	57
6	20g	18	60
8	38g	19	62
10	68g	23	72
T10	1g	13	44
T15	2g	15	48
T20	4g	18	56
T25	5g	20	63
T27	10g	24	70
T30	18g	27	80
T40	28g	31	90
T45	58g	35	100
T50	102g	40	112

123159

CHAVE CORRESPONDENTE CORRESPONDING KEY CLAVE CORRESPONDENTE	KG	DIMENSÕES SIZE TAMAÑO (MM)	
		A	B
1,5	1,4 g	15	63
2	2 g	18	77
2,5	4 g	20	87
3	7 g	23	93
4	14 g	29	104
5	25 g	33	120
6	41 g	38	141
8	84 g	44	158
10	145 g	50	180
T10	6,2 g	23	93
T15	9 g	25	98
T20	12,5 g	29	104
T25	17,2 g	30	114
T27	22,4 g	33	120
T30	31,8 g	38	141
T40	53,6 g	41	147
T45	75 g	44	158
T50	101 g	47	169

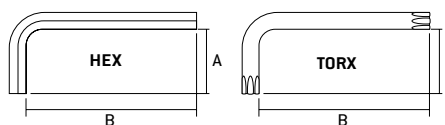

- Acabamento acetinado | Satin Finish | Acabado santinado
- Estojo em tecido | Fabric case | Estuche de tela

Estojo de Chaves Allen de 10 peças

Allen key case - 10 peices | Estuche de llaves Allen 10 piezas



10
peças
parts | piezas

			Quant. Min.
123099	1,5 2,0 2,5 3,0 4,0 5,0 6,0 8,0 10,0 12,0 mm - Curtas	48	12
123109	1,5 2,0 2,5 3,0 4,0 5,0 6,0 8,0 10,0 12,0 mm - Extra Longa	36	12



123109

CHAVE CORRESPONDENTE CORRESPONDING KEY CLAVE CORRESPONDENTE	KG	DIMENSÕES SIZE TAMAÑO (MM)	
		A	B
1,5	1,6g	13	91
2,0	3,2g	15	102
2,5	5,6g	18	114
3,0	9,1g	20	129
4,0	18,2g	24	144
5,0	32,5g	27	165
6,0	53,2g	31	188
8,0	104,9g	35	208
10,0	183,6g	40	234
12,0	260 g	55	259

123099

CHAVE CORRESPONDENTE CORRESPONDING KEY CLAVE CORRESPONDENTE	KG	DIMENSÕES SIZE TAMAÑO (MM)	
		A	B
1,5	1g	13	44
2	2g	15	48
2,5	4g	18	56
3	5g	20	63
4	10g	24	70
5	18g	27	80
6	28g	31	90
8	58g	35	100
10	102g	40	112
12	167 g	50	137

- Acabamento acetinado | Satin Finish | Acabado santinado

Estojo de Chaves Allen de 10 peças abaulada

Allen key case - 10 peices Round edge | Estuche de llaves Allen 10piezas Punta Redonda



10
peças
parts | piezas

123119	1,5 2,0 2,5 3,0 4,0 5,0 6,0 8,0 10,0 mm - Extra Longa	36	12
--------	---	----	----



CHAVE CORRESPONDENTE CORRESPONDING KEY CLAVE CORRESPONDENTE	KG	DIMENSÕES SIZE TAMANO (MM)	A	B
1,5	1,6g	13	91	
2,0	3,2g	15	102	
2,5	5,6g	18	114	
3,0	9,1g	20	129	
4,0	18,2g	24	144	
5,0	32,5g	27	165	
6,0	53,2g	31	188	
8,0	104,9g	35	208	
10,0	183,6g	40	234	

Permite trabalhar com um ângulo de até 25° em relação ao eixo do parafuso.

This key allows you to work on screws situated up to 25° from the vertical.

Permite trabajar con un ángulo de hasta 25° con relación al eje del tornillo.

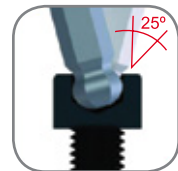

- Acabamento acetinado | Satin Finish | Acabado santinado
- Ponta Abaulada | Round edge | Punta Redonda

Estojo de Chaves Torx de 9 peças

Torx key case - 9 peices | Estuche de Chaves Torx de 9 piezas



9
peças
parts | piezas

123129	T10 T15 T20 T25 T27 T30 T40 T45 T50 - curta	48	12
123139	T10 T15 T20 T25 T27 T30 T40 T45 T50 - longa	36	12



123129

CHAVE CORRESPONDENTE CORRESPONDING KEY CLAVE CORRESPONDENTE	KG	DIMENSÕES SIZE TAMANO (MM)	A	B
T10	1g	13	44	
T15	2g	15	48	
T20	4g	18	56	
T25	5g	20	63	
T27	10g	24	70	
T30	18g	27	80	
T40	28g	31	90	
T45	58g	35	100	
T50	102g	40	112	

123139

CHAVE CORRESPONDENTE CORRESPONDING KEY CLAVE CORRESPONDENTE	KG	DIMENSÕES SIZE TAMANO (MM)	A	B
T10	1,4g	13	63	
T15	2g	15	77	
T20	4g	18	87	
T25	7g	20	93	
T27	14g	24	104	
T30	25g	27	120	
T40	41g	31	141	
T45	84g	35	158	
T50	145g	40	180	

- Acabamento acetinado | Satin Finish | Acabado santinado
- Com furo | With hole | Con agujero

Caixa de bits /Ponteira 50mm
 Bit set Box / Tip 50mm | Caja de bits / Puntera 50mm



113829	1/4" (PH 2)	DIMENSÕES SIZE TAMAÑO (MM)		160	12*
		A	B		
		6,35 mm	50mm		

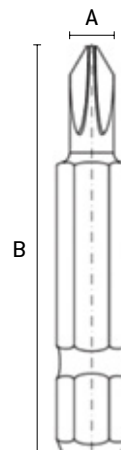

- Encaixe Sextavado | Fitting Sixth | Encaje Sextavado
- Caixa Plástica | Plastic box | Caja de plástico

Linha de Bits Ponteira Phillips 5 Peças
 Phillips Point Bits Line 5 Pieces | Línea de Bits Puntera Phillips 5 Piezas



1136155	PH1 - 4,0 x 25 mm	DIMENSÕES SIZE TAMAÑO (MM)		200	25
		A	B		
1136255	PH2 - 5,0 x 25 mm	5	25	200	25
1136355	PH3 - 6,0 x 25 mm	6	25	200	25
1136455	PH1 - 4,0 x 38 mm	4	38	200	25
1136555	PH2 - 5,0 x 38 mm	5	38	200	25
1136655	PH3 - 6,0 x 38 mm	6	38	200	25
1136755	PH1 - 4,0 x 50 mm	4	50	200	25
1136855	PH2 - 5,0 x 50 mm	5	50	200	25
1136955	PH3 - 6,0 x 50 mm	6	50	200	25
1137055	PH1 - 4,0 x 75 mm	4	75	200	25
1137155	PH2 - 5,0 x 75 mm	5	75	200	25
1137255	PH3 - 6,0 x 75 mm	6	75	100	25

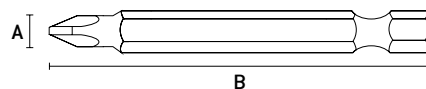

- Encaixe Sextavado 1/4" | Hex socket 1/4 " | Encaje Sexto 1/4 "

Linha de Bits Industrial TORX
Cromo Molibdênio 5 Peças

Industrial Bit Series Chrome Molybdenum 5 Pieces |
Línea de Bits Industrial Cromo Molibdeno 5 Piezas



Barcode	SKU	DIMENSÕES SIZE TAMAÑO (MM)		Box	Quant. Min.
		A	B		
1130155	T6 x 25 mm	T6	25	200	25
1130255	T7 x 25 mm	T7	25	200	25
1130355	T8 x 25 mm	T8	25	200	25
1130455	T9 x 25 mm	T9	25	200	25
1130555	T10 x 25 mm	T10	25	200	25
1130655	T15 x 25 mm	T15	25	200	25
1130755	T20 x 25 mm	T20	25	200	25
1130855	T25 x 25 mm	T25	25	200	25
1130955	T27 x 25 mm	T27	25	200	25
1131055	T30 x 25 mm	T30	25	200	25
1131155	T40 x 25 mm	T40	25	200	25
1131255	T6 x 50 mm	T6	50	200	25
1131355	T7 x 50 mm	T7	50	200	25
1131455	T8 x 50 mm	T8	50	200	25
1131555	T9 x 50 mm	T9	50	200	25
1131655	T10 x 50 mm	T10	50	200	25
1131755	T15 x 50 mm	T15	50	200	25
1131855	T20 x 50 mm	T20	50	200	25
1131955	T25 x 50 mm	T25	50	200	25
1132055	T27 x 50 mm	T27	50	200	25
1132155	T30 x 50 mm	T30	50	200	25
1132255	T40 x 50 mm	T40	50	200	25
1132355	T6 x 75 mm	T6	75	100	25
1132455	T7 x 75 mm	T7	75	100	25
1132555	T8 x 75 mm	T8	75	100	25
1132655	T9 x 75 mm	T9	75	100	25
1132755	T10 x 75 mm	T10	75	100	25
1132855	T15 x 75 mm	T15	75	100	25
1132955	T20 x 75 mm	T20	75	100	25
1133055	T25 x 75 mm	T25	75	100	25
1133155	T27 x 75 mm	T27	75	100	25
1133255	T30 x 75 mm	T30	75	100	25
1133355	T40 x 75 mm	T40	75	100	25

• Encaixe Sextavado 1/4" | Hex socket 1/4 " | Encaje Sexto 1/4 "

Linha de Bits Ponteira Fenda 5 Peças

Fenda Point Bits Line 5 Pieces | Línea de Bits Puntera Fenda 5 Piezas







Barcode	SKU	DIMENSÕES SIZE TAMAÑO (MM)		Box	Quant. Min.
		A	B		
1134055	SL3,5 x 25 mm	3,5	25	200	25
1134155	SL4,0 x 25 mm	4,0	25	200	25
1134255	SL4,5 x 25 mm	4,5	25	200	25
1134355	SL5,0 x 25 mm	5,0	25	200	25
1134455	SL6,0 x 25 mm	6,0	25	200	25
1134555	SL8,0 x 25 mm	8,0	25	200	25
1134655	SL4,0 x 38 mm	4,0	38	200	25
1134755	SL4,5 x 38 mm	4,5	38	200	25
1134855	SL5,0 x 38 mm	5,0	38	200	25
1134955	SL6,0 x 38 mm	6,5	38	200	25
1135055	SL8,0 x 38 mm	8,0	38	200	25
1135155	SL10,0 x 38 mm	10,0	38	200	25
1135255	SL3,5 x 50 mm	3,5	50	200	25
1135355	SL4,0 x 50 mm	4,0	50	200	25
1135455	SL4,5 x 50 mm	4,5	50	200	25
1135555	SL6,0 x 50 mm	6,0	50	200	25
1135655	SL8,0 x 50 mm	8,0	50	200	25
1135755	SL3,5 x 75 mm	3,5	75	100	25
1135855	SL4,0 x 75 mm	4,0	75	100	25
1135955	SL6,0 x 75 mm	6,0	75	100	25
1136055	SL8,0 x 75 mm	8,0	75	100	25

• Encaixe Sextavado 1/4" | Hex socket 1/4 " | Encaje Sexto 1/4 "

Conjunto de bits de dois lados PH2 45mm 10 pçs

Double Sided Bits 45mm | Conjunto de bits de dois lados 45mm

 antigo	 novo		DIMENSÕES SIZE TAMAÑO (MM)			 Quant. Min.
11209	1120955	(PH 2)1/4"	A	B	50	15
			6,35	45		

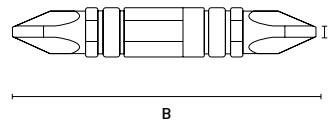





- Aço CrMo | Stel CrMo | Acero CrMo
- Encaixe Sextavado 1/4" | Hex socket 1/4 " | Encaje Sexto 1/4 "
- Ponta Dupla Imantada | Magnet Double Tip | Punta Doble Magnetizada
- Tamanho: 45mm | Size: 45mm | Tamaño: 45mm

Ranuras para maior aderência
Grooves for added grip
Ranuras para una mayor adherencia



Conjunto de bits PH2 70 mm 10 pçs

Set of 70 mm bits | Conjunto de bits 70 mm

 antigo	 novo		DIMENSÕES SIZE TAMAÑO (MM)			 Quant. Min.
11262	1126256	(PH 2)1/4"	A	B	50	10
			6,35	70		







- Ponta Imantada | Magnet Tip | Punta Magnetizada
- Aço CrMo | Stel CrMo | Acero CrMo
- Encaixe Sextavado 1/4" | Hex socket 1/4 " | Encaje Sexto 1/4 "
- Tamanho: 70mm | Size: 70mm | Tamaño: 70mm

Ranuras para maior aderência
Grooves for added grip
Ranuras para una mayor adherencia



Conjunto de bits PH2 90mm - 10pçs

Set of 90mm bits 10pcs | Conjunto de bits 90mm 10pzs

 antigo	 novo		DIMENSÕES SIZE TAMAÑO (MM)			 Quant. Min.
11263	1126356	(PH 2)1/4"	A	B	50	10
			6,35	90		

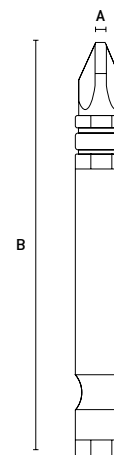

- Ponta Imantada | Magnet Tip | Punta Magnetizada
- Aço CrMo | Stel CrMo | Acero CrMo
- Encaixe Sextavado 1/4" | Hex socket 1/4 " | Encaje Sexto 1/4 "
- Tamanho: 70mm | Size: 70mm | Tamaño: 70mm

Conjunto de bits 25mm - 10 pçs

Set of 25mm bits - 10 pcs | Conjunto de bits 25mm - 10 pcs



antigo	novo		DIMENSÕES SIZE TAMAÑO (MM)			Quant. Min.
			A	B		
11329	1132956	(PH 1) 3/16"	4,763	25	60	20
11330	1133056	(PH 2) 1/4"	6,35	25	60	20

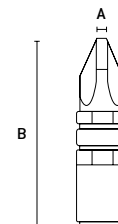

10 peças
parts | piezas

- Ponta Imantada | Magnet Tip | Punta Magnetizada
- Aço CrMo | Stel CrMo | Acero CrMo
- Encaixe Sextavado 1/4" | Hex socket 1/4 " | Encaje Sexto 1/4 "
- Tamanho: 25mm | Size: 25mm | Tamaño: 25mm

Conjunto de bits PH2 25 mm 2 pçs

Set of 25 mm bits | Conjunto de bits 25 mm

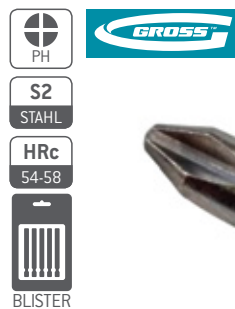

antigo	novo		DIMENSÕES SIZE TAMAÑO (MM)			Quant. Min.
			A	B		
11349	1134956	(PH 1) 3/16"	4,763	25	60	20
11351	1135156	(PH 2) 1/4"	6,35	25	60	20

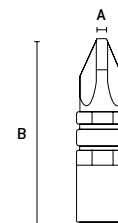

10 peças
parts | piezas

- Ponta Imantada | Magnet Tip | Punta Magnetizada
- Aço CrMo | Stel CrMo | Acero CrMo
- Encaixe Sextavado 1/4" | Hex socket 1/4 " | Encaje Sexto 1/4 "
- Tamanho: 70mm | Size: 70mm | Tamaño: 70mm

Conjunto de bits 50/70/90mm 10 pçs

Bit set 50/70/90mm | Conjunto de bits 50/70/90mm

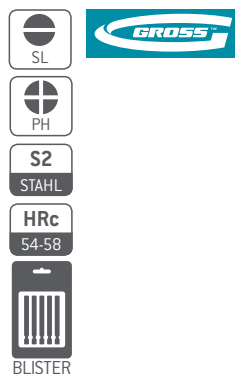

antigo	novo		DIMENSÕES SIZE TAMAÑO ()			Quant. Min.
			A	B		
11325	1132556	(SL 5) 7/32"	5,55	50	60	20
11326	1132656	(SL 6) 1/4"	6,35	50	60	20
11334	1133455	(PH 1) 3/16"	4,736	50	60	20
11335	1133555	(PH 2) 1/4"	6,35	50	60	20
11336	1133655	(PH 3) 5/16"	7,938	50	60	20
11378	1137855	(PH 1) 3/16"	4,763	70	60	20
11379	1137955	(PH 2) 1/4"	6,35	90	60	20

10 peças
parts | piezas

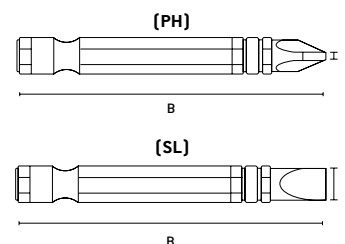

- Encaixe Sextavado 1/4" | Hex socket 1/4 " | Encaje Sexto 1/4 "

Conjunto de bits adaptador magnético 50mm 2 pçs

Magnetic adapter bit set 50mm | Conjunto de bits magnético 50mm

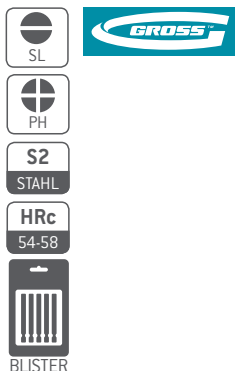

2
peças
parts / piezas

antigo	novo	[]	DIMENSÕES SIZE TAMAÑO (MM)		Quant. Min.
			A	B	
11355	1135556	[PH1] 3/16"	4,763mm	50mm	60 20
11357	1135756	[PH2] 1/4"	6,35mm	50mm	60 20
11359	1135956	[PH3] 5/16"	7,938mm	50mm	60 20
11376	1137655	[SL5] 1/4"	6,35mm	50mm	60 20

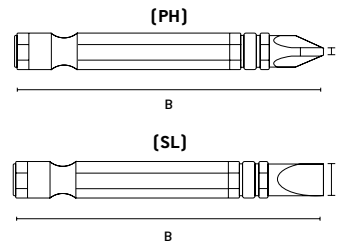

- Ponta Imantada | Magnet Tip | Punta Magnetizada
- Encaixe Sextavado 1/4" | Hex socket 1/4 " | Encaje Sexto 1/4 "
- Tamanho: 50mm | Size: 50mm | Tamaño: 50mm

Conjunto de bits com limitador

Bit set with limiter | Conjunto de bits con limitador

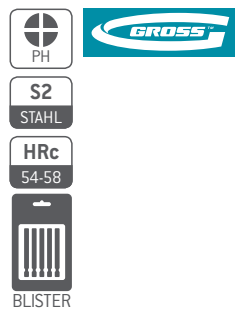

antigo	novo	[]	DIMENSÕES SIZE TAMAÑO (MM)		Quant. Min.
			A	B	
11455	1145556	[PH2] 1/4"	6,35mm	25mm	60 10
11456	1145656	[PH2] 1/4"	6,35mm	50mm	60 10

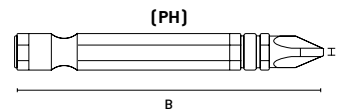

- Encaixe Sextavado 1/4" | Hex socket 1/4 " | Encaje Sexto 1/4 "
- Imantado e com limitador | Magnetized and with limite | Magnetizado y con limitador
- Tamanho: 25mm|50mm | Size: 25mm|50mm | Tamaño: 25mm|50mm
- Aplicação para parede Gesso /Drywall | Wall application Plaster / Drywall | Aplicación para pared Yeso / Drywall

Jogo de Bits/Ponteiras 7pçs

Bits / Tips Set 7pc | Juego de Bits / Puntas 7pç



7
peças
parts / piezas



113929	SL, PH, PZ	120	10
--------	------------	-----	----

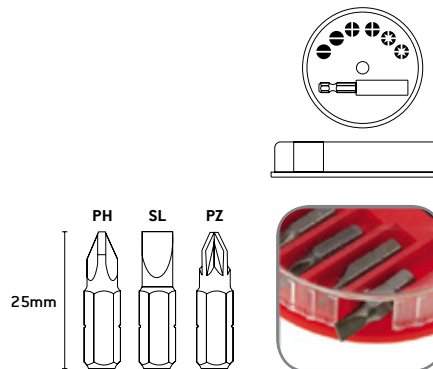

- Adaptador Magnético | Magnetic Adapter | Adaptador magnético
- Bits Tamanho: 25mm | Bits Size: 25mm | Bits Tamaño: 25mm

Composição | Composition | composición:
 • 1 adaptador magnético | magnetic adapter | adaptador magnético para bits
 • 6 pçs
 bits: PH1/PH2/PZ1/PZ2/SL5/SL7

Maleta Conjunto de bits e cabeças 26 pçs

Case Set of bits and heads 26 pcs | Maleta Conjunto de bits y cabezas 26 pçs



antigo	novo	KG	DIMENSÕES SIZE TAMAÑO (MM)	Quant. Min.
11361	1136156	SL/PH/PZ/TR/HEX	A 133 B 194	30 15

26 peças
parts | piezas

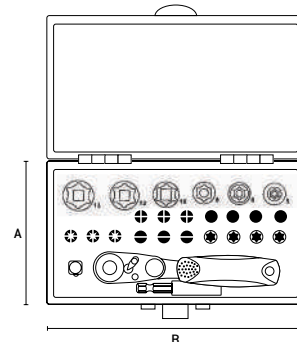

- Aço CrMo | Steel CrMo | Acero CrMo
- Adaptador Magnético | Magnetic Adapter | Adaptador magnético
- Catraca reversível | Reversible ratchet | Catraca reversible
- Encaixe 1/4" | 1/4 "socket | Enchufe 1/4 "
- Bits Tamanho: 25mm | Bits Size: 25mm | Bits Tamaño: 25mm

Composição | Composition | composición:

- 1 adaptador Quadrado | 1 Square adapter 25mm
- 1 Chave de catraca 52 dentes | Ratchet wrench 52 teeth | Llave de trinquete 52 dientes
- 17 bits PH1/PH2/PH3/PZ1/PZ2/PZ3
TORX: T10, T15, T20, T25, T27, T30, T40
HEX 3/4/5/6mm
- 6 Soquetes | Sockets de 1/4" 5/6/8/10/12/13mm

Maleta Conjunto de bits e cabeças 33 pçs

Case Set of bits and heads 33 pcs | Maleta Conjunto de bits y cabezas 33 pçs



antigo	novo	KG	DIMENSÕES SIZE TAMAÑO (MM)	Quant. Min.
11365	1136556	SL, PH, TR, HEX, TT, PZ	A 133 B 194	30 15

33 peças
parts | piezas

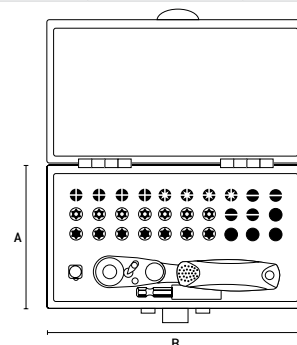

- Adaptador Magnético | Magnetic Adapter | Adaptador magnético
- Catraca reversível | Reversible ratchet | Catraca reversible
- Encaixe 1/4" | 1/4 "socket | Enchufe 1/4 "
- Bits Tamanho: 25mm | Bits Size: 25mm | Bits Tamaño: 25mm

Composição | Composition | composición:

- 1 adaptador Quadrado | 1 Square adapter 25mm
- 1 adaptador magnético | adapter magnetic
- 1 Chave de catraca 52 dentes | Ratchet wrench 52 teeth | Llave de trinquete 52 dientes
- 30 bits PH1, PH2, PH3, PZ1, PZ2, PZ3
TORX: T10, T15, T20, T25, T27, T30, T40
TORX com guia: T10, T15, T20, T25, T27, T30, T40
H3, H4, H5, H6 / SL3, SL4, SL5, SL6

Maleta Conjunto de bits e cabeças 61 pçs

Case Set of bits and heads 61 pcs | Maleta Conjunto de bits y cabezas 61 pçs



113879	SL, PH, TR, SPAN, HEX, TT, PZ soquetes, SP	KG	DIMENSÕES SIZE TAMAÑO (MM)	Quant. Min.
		469g	A 89 B 127	36 12

61 peças
parts | piezas

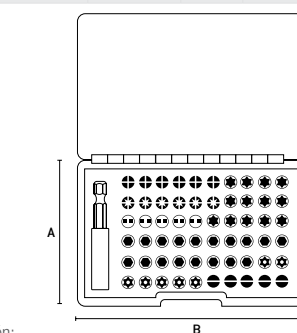

- Aço CrV | Steel CrV | Acero CrV
- Adaptador Magnético - IMÁ MINEDIN | MINEDIN Magnetic Adapter | Adaptador magnético - MINEDIN
- Encaixe 1/4" | 1/4 "socket | Enchufe 1/4 "
- Bits Tamanho: 25mm | Bits Size: 25mm | Bits Tamaño: 25mm

Composição | Composition | composición:

- 1 adaptador magnético | magnetic adapter | adaptador magnético para bits
- 60 bits
5 Fenda: 3, 4, 5, 6 e 7 mm
7 Torx com guia: T10, T15, T20, T25, T27, T30 e T35
6 Allen com guia: 2, 2.5, 3, 4, 5 e 6 mm
12 Allen: 1.5, 2, 2.5, 3, 3.5, 4, 4.5, 5, 5.5, 6, 7 e 8 mm
9 Torx: T9, T10, T15, T20, T25, T27, T30, T35 e T40
5 Spanner: (2) 4, 6, 8 e 10 / # 6 Pozidriv: PZ0, PZ1, (3) PZ2 e PZ3
6 Phillips: PH0, PH1, (3) PH2 e PH3

**Maleta Conjunto de Bits/
Ponteiras e Brocas 40pçs**

Bits / Tips and Drills Set 40pçs |
Maleta Conjunto de Bits / Puntas y Brocas 40pçs



- Aço CrV | Stel CrV | Acero CrV
- Adaptador Magnético | Magnetic Adapter | Adaptador magnético
- Bits Tamanho: 25mm | Bits Size: 25mm | Bits Tamaño: 25mm

113229	SL, PH, PZ, TR, brocas drills	742g	DIMENSÕES SIZE TAMAÑO (MM)			12	Quant. Min.
			A	B	C		
			226	257			

40
peças
parts | piezas

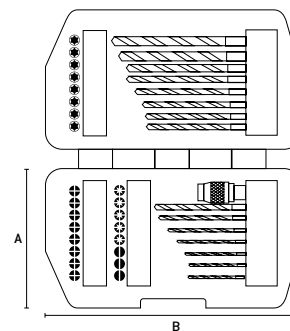

Composição | Composition | composición:

- 1 adaptador magnético | magnetic adapter | adaptador magnético para bits
- 24pçs bits: PH0/ PH1/PH2/PH3 PZ0/PZ1/PZ2/PZ3 T8/T10/T15/T20/T25/T27/T30/ T40 SL4/ SL5/ SL6/ SL7/ SL8mm broca: 1/1,5/2/2,5/3/3,2/3,5/4/4,5/4,8/5/5,5/6mm

Jogo de Bits/Ponteiras 18pçs

Bits / Tips Set 18pçs | Juego de Bits / Puntas 18pçs



113839	SL, PH, TR, SPAN, HEX, TT, PZ soquetes, SP	256g	DIMENSÕES SIZE TAMAÑO (MM)			48	12
			A	B	C		
			178	198	39		

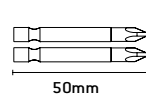

18
peças
parts | piezas

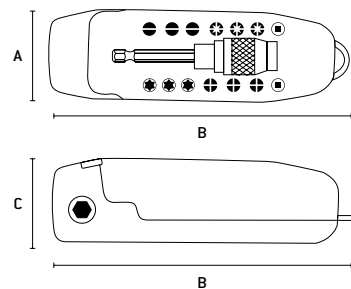

Encaixe Lateral
Lateral Attachment
Encaje Lateral



Composição | Composition | composición:

- 1 adaptador 65mm | adapter | adaptador
- 1 Carabiner
- 14 bits 25mm: PH1/PH2/PH3/PZ1/PZ2/PZ3 SL3/SL4/SL5/T10/T15/T25/S1/S2
- 2 bits 50mm: PZ1/PZ2

Bits / Ponteira - 1/4"

Bits / Tips - 1/4" | Bits / Ponteira - 1/4"



113989	207g	DIMENSÕES SIZE TAMAÑO (MM)			100	1
		A	B	C		
117929	20g	52	110	11	200	10

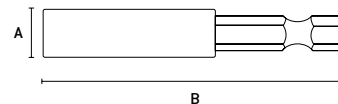

- 113989
• 10 peça | piece | pieza

- 117929
• 1 peça | piece | pieza

- Adaptador Magnético | Magnetic Adapter | Adaptador magnético
- Encaixe 1/4" | Fitting 1/4" | Encaje 1/4"

Soquetes Magnéticos - 2 pçs
Magnetic Sockets | Soportes Magnéticos



Código	Qtd	DIMENSÕES SIZE TAMAÑO (MM)		Cód. Produto	Quant. Min.
		Ø	B		
115669	2pçs	6mm	45mm	480	80
115689	2pçs	7mm	45mm	480	20
115699	2pçs	8mm	45mm	480	20
115719	2pçs	10mm	45mm	480	20
115739	2pçs	8mm	65mm	300	10
115769	2pçs	10mm	65mm	300	10
117899	2pçs	12mm	45mm	200	10
117889	2pçs	13mm	45mm	200	10
117909	2pçs	12mm	65mm	200	10
117919	2pçs	13mm	65mm	200	10

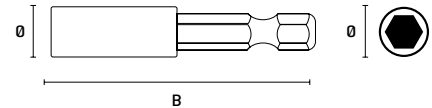

- Encaixe 1/4" | Fitting 1/4" | Encaje 1/4"
- Embalagem com 2 peças | Packing with 2 pieces | Embalaje con 2 piezas

Pulseira Magnética

Magnetic Bracelet | Pulsera magnética



Código	KG	DIMENSÕES SIZE TAMAÑO (MM)			Cód. Produto	Quant. Min.
		A	B	C		
115649	123g	53	310	29	100	1

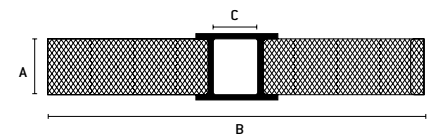

- Para pregos, pinos e parafuso | For nails, pins and bolts | Para clavos, pernos y tornillos

Chave de bits reversível com dobradiça - 18 pçs

Reversible bit key with hinged | Llave de bits reversible con bisagra

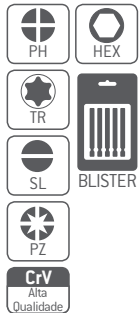

Código	Compatibilidade	KG	DIMENSÕES SIZE TAMAÑO (MM)		Cód. Produto	Quant. Min.
			A	B		
1155455	SL, PH, TR, HEX, PZ	333g	35	265	48	24

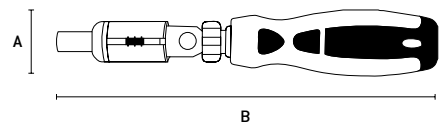

Composição | Composition | composición:

- 1 chave de bits e soquetes | 1 bit key and sockets | 1 clave de bits y sockets
- 1 adaptador para bits | 1 bit adapter | 1 adaptador para bits
- 10 bits 25mm: PH2/PH3/PZ2/PZ3/SL4/SL5/SL6/SL7/TR15/TR20
- 6 soquetes | sockets | enchufe : HEX 5/6/7/8/9/10

Chave de bits com catraca reversível - 14 pçs

Reversible ratchet bit key | Llave de bits con trinquete reversible



antigo	novo	Código	Compatibilidade	KG	DIMENSÕES SIZE TAMAÑO (MM)		Cód. Produto	Quant. Min.
					A	B		
115565	1155655	1155655	SL, PH, HEX	278g	115	32	72	30

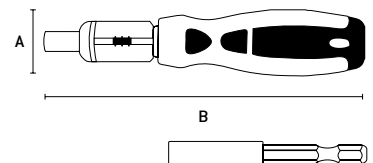

Composição | Composition | composición:

- 1 chave de bits e soquetes | 1 bit key and sockets | 1 clave de bits y sockets
- 1 adaptador para bits | 1 bit adapter | 1 adaptador para bits
- 6 bits 25mm: PH1/PH2/PH3/SL4/SL5/SL7
- 6 soquetes | sockets | enchufe : HEX 5/6/7/8/9/10

Chave reversível com bits/ponteira/soquetes-16pçs

Reversible switch with bits/bushing/sockets-16pcs | Llave reversible con bits/puntera/enchufe-16pzs



BLISTER



16 peças
parts | piezas

- Encaixe Sextavado 1/4" | Hex socket 1/4 " | Encaje Sexto 1/4 "
- Tamanho: 50mm | Size: 50mm | Tamaño: 50mm

113329	SL, PH, HEX, PZ	340g	DIMENSÕES SIZE TAMAÑO (MM)				Quant. Min.
			A	B			12

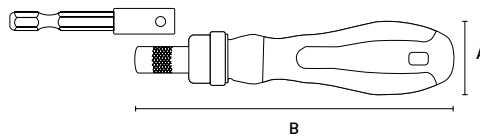

Composição | Composition | composición:

- 1 chave de bits e soquetes | 1 bit key and sockets | 1 clave de bits y sockets
- 1 adaptador para soquetes | 1 socket adapter | 1 adaptador para sockets
- 1 extensor para soquetes | 1 socket extender | 1 extensor para sockets
- 9 bits 25mm: PH1/PH2/PH3/SL4/SL5/SL6/PZ1/PZ2/PZ3
- 4 soquetes | sockets | enchufe : HEX (1/4")5/6/10/11

Chave de bits com alça ergonômica em forma de T 12 pçs

Bit key with T-shaped ergonomic handle |

Llave de bits con mango ergonómico en forma de T



BLISTER

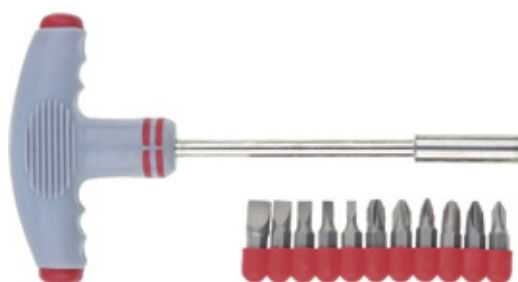

12 peças
parts | piezas

- 1 Cabo adaptador "T" | 1 Adapter cable | 1 cable adaptador
- 11 bits 25mm:
PH1/PH2/PH3
SL3/SL4/SL5/SL6/SL8
PZ1/PZ2/PZ3

115679	SL, PH, PZ	80g	DIMENSÕES SIZE TAMAÑO (MM)				Quant. Min.
			A	B	C		1

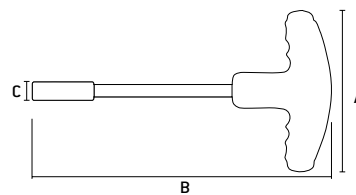

Chave de Fenda/Phillips

Screwdriver / Phillips | Destornillador / phillips



BLISTER



antigo	novo		KG	DIMENSÕES SIZE TAMAÑO (MM)				Quant. Min.	
115875	1158755	SL6/PH2 1/4"	47g	A	B	C	D		100

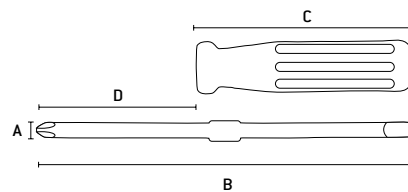

- Ponta Dupla | Double Tip | Ponta Doble

Chave manual de impacto - 7pçs

Rotary impact wrench - 7pcs | Llave de impacto rotativo - 7pzs



			DIMENSÕES SIZE TAMAÑO [MM]				
115759	SL, PH	884g	A	B	C	25	1

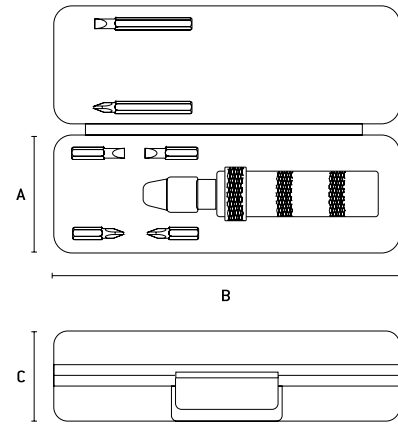

Composição | Composition | composición:
 • 1 chave de impacto | 1 key of impact | 1 clave de impacto
 • 6 bits : PH2 x 35mm / PH3 x 35mm / Ph3 x 65mm
 SL2 X 35mm / SL8 X 35mm / SL8 X 65mm

Jogo de Ferramentas

Tool Set | Juego de herramientas



Composição | Composition | composición:

- 1 Chave de fenda reversível
Reversible screwdriver | Llave de ranura reversible
- 1 adaptador | adapter
- 1 suporte de bit | bit support | soporte de bits
- 1 chave de fenda para trabalho de precisão
Screwdriver for precision work | Destornillador para trabajo de precisión
- 1 alicate corte diagonal | diagonal cutting pliers
- 1 alicate de nariz longo | long nose pliers | alicate de nariz larga
- 1 magnetizador | magnetizer
- Bits para chave de fenda reversa:
Reverse Screwdriver Bits | Bits para destornillador inversa

T10, T15, T20 (2 pçs), T25 (2 pçs) T27, T30

SL3, SL4, SL5 (2 pçs) SL6

PH0, PH1, PH2 (2 pçs), PH3;

PZ0, PZ1, PZ2, PZ3

H3, H4, H5, H6

S0, S1, S2, S3;

• Bits de chave de fenda para trabalho de precisão:
Screwdriver bits for precision work | Bits de destornillador para trabajo de precisión

T4, T5, T6, T7, T8, T9, T10, T15, T20

SI1, S1.5, S2, S2.5, S3, S3.5, S4

PH000 (2 pçs), PH0, PH1;

Pz0, Pz1;

H0,7/H0,9/H1,3/H1,5/H2/H2,5/H3/H3,5/H4;

• Cabeça hexagonal para a chave de fenda reversa:
Hex Head for Reverse Screwdriver | Cabeza hexagonal para el destornillador inverso

5mm, 6mm, 7mm, 8mm, 9mm, 10mm, 11mm, 12mm, 13mm.

			DIMENSÕES SIZE TAMAÑO [MM]			
117859	SL, PH, TR, HEX, PZ	1,04Kg	A	B	12	3

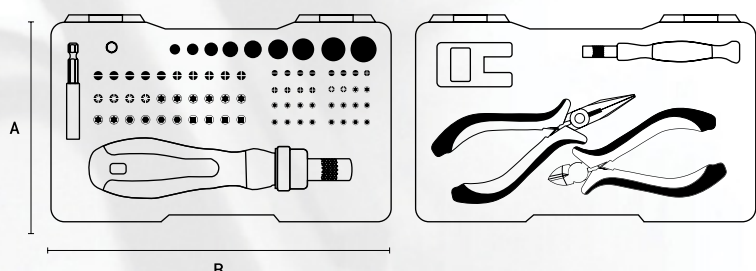

Caixa de bits /Ponteira Multidentada / adaptador 1/2" x 10 mm

Bit set Box Multidentate / Tip | Caja de bits / Puntera Multidentate



				DIMENSÕES SIZE TAMAÑO (MM)				
11312	1131256	Bits Spline	633g	A	B	C	30	6

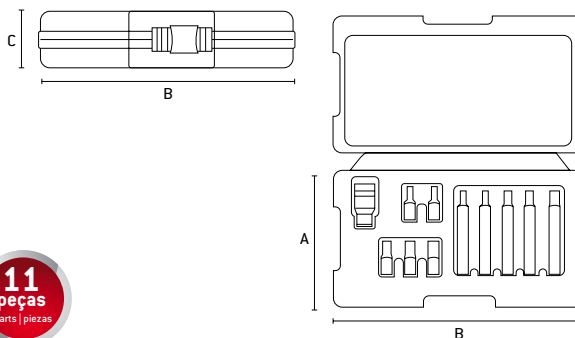

11 peças
parts | piezas

Composição | Composition | composición:

- 1 adaptador | adapter 1/2" x 10mm
- Bits 30mm: M5/M6/M8/M10/M12
- Bits 75mm: M5/M6/M8/M10/M12

- Encaixe Sextavado 10 mm | Fitting Sixth 10 mm | Encaje Sextavado 10 mm
- Caixa Plástica | Plastic box | Caja de plástico

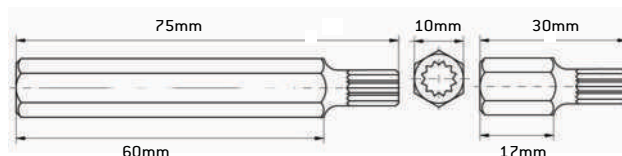

Caixa de bits /Ponteira Sextavado / adaptador de 1/2" x 10 mm

Bit set Box Sixth grade / Tip | Caja de bits / Puntera hexagonal



				DIMENSÕES SIZE TAMAÑO (MM)				
11313	1131356	Bits Sextavado	767g	A	B	C	30	6

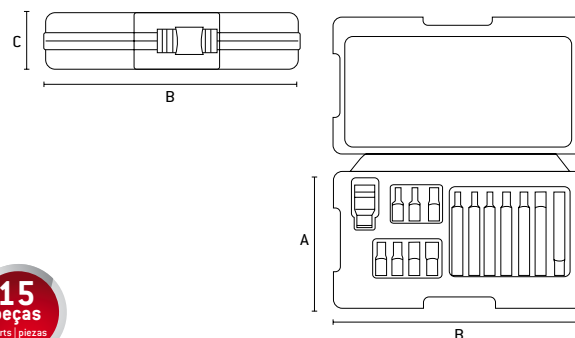

15 peças
parts | piezas

Composição | Composition | composición:

- 1 adaptador | adapter 1/2" x 10 mm
- Bits 30mm: 4,0/5,0/6,0/7,0/8,0/10/12mm
- Bits 75mm: 4,0/5,0/6,0/7,0/8,0/10/12mm

- Caixa Plástica | Plastic box | Caja de plástico

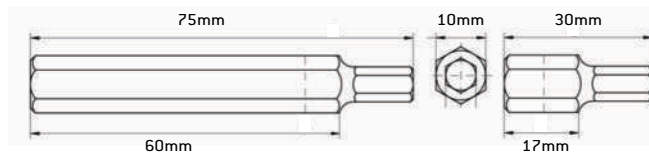

Caixa de bits /Ponteira Torx / adaptador de 1/2 x 10 mm

Bit set Box Torx / Tip | Caja de bits / Puntera Torx



				DIMENSÕES SIZE TAMAÑO [MM]				
11315	1131556	Bits Torx	738g	A 135	B 225	C 51	30	1

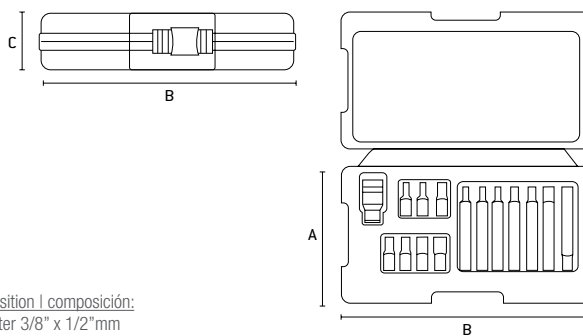

15
peças
parts | piezas

Composição | Composition | composición:

- 1 adaptador | adapter 3/8" x 1/2" mm
- Bits 30mm: T20/T25/T30/T40/T45/T50/T55
- Bits 75mm: T20/T25/T30/T40/T45/T50/T55

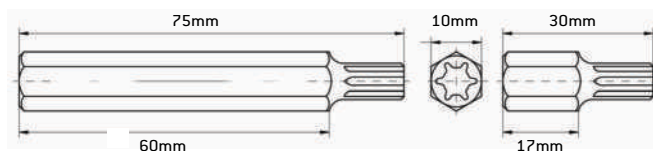

- Caixa Plástica | Plastic box | Caja de plástico

Caixa de bits /Ponteira Multidentada / adaptador de 1/2" x 10 mm

Bit set Box Multidentate / Tip | Caja de bits / Puntera Multidentate

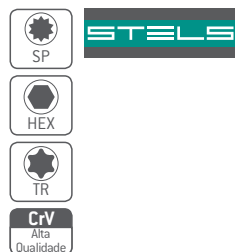

				DIMENSÕES SIZE TAMAÑO [MM]				
11318	1131856	Bits Hex Torx Spline	1.692g	A 172	B 240	C 52	12	1

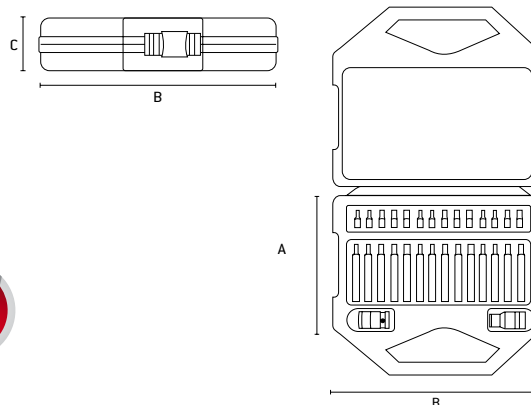

42
peças
parts | piezas

Composição | Composition | composición:

- 1 adaptador | adapter 3/8" x 10mm
- 1 adaptador | adapter 1/2" x 10mm
- (7 unid.) HEX Bits 4-5-6-7-8-10-12 x 30
- (7 unid.) HEX Bits 4-5-6-7-8-10-12 x 75
- (8 unid.) Bits Torx 20-25-30-40-45-50-55-60 x 30
- (8 unid.) Bits Torx 20-25-30-40-45-50-55-60 x 75
- (5 unid.) Spline Bits M5-6-8-10-12 x 30
- (5 unid.) Spline Bits M5-6-8-10-12 x 75

• SPLINE

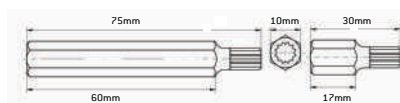

• HEX

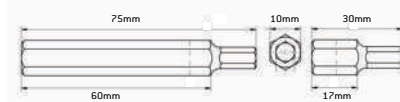

• TORX

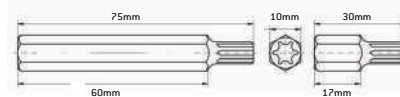

- Caixa Plástica | Plastic box | Caja de plástico

Chave Phillips Ponta imantada

Phillips head Magnetic tip | Llave Phillips Extremidad imantada

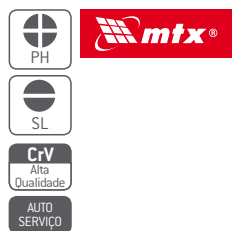

Código	Descrição	DIMENSÕES SIZE TAMAÑO (MM)				Quant. Min.	
		A	B	C	D		
114069	SL 3 - 1/8" x 3"	3,2	150	25	75	240	12*
114189	SL 6 - 1/4" x 1"	6,3	50	40	25	144	12*

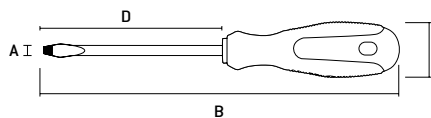

- Cabo anatômico | Anatomical cable | Cable anatómico
- Cabo emborrachado de três componentes | Tree-component rubberized cable | Cable de goma de tres componentes
- Embalagem: Clipe Plástico | Packing: Plastic Clip | Embalaje: Clip Plástico

Chaves VDE

VDE Keys | Llaves VDE

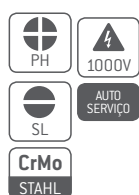

Código	Descrição	DIMENSÕES SIZE TAMAÑO (MM)				Quant. Min.
		A	B	C	D	
129149	SL 3 - 1/8" x 3"	4,7	150	25	120	12*
129169	SL 4 - 5/32" x 4"	4	200	30	120	12*
129189	SL 5 - 7/32" x 5"	5,5	250	30	120	12*
129249	PH 0 - 1/8" x 3"	3	150	25	120	12*

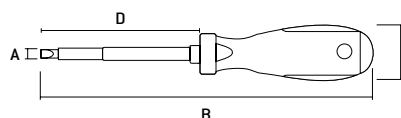

- Cabo anatômico | Anatomical cable | Cable anatómico
- Cabo emborrachado de dois componentes | Two-component rubberized cable | Cable de goma de dos componentes
- Haste isolada 1000V - VDE | 1000V insulated rod - VDE | Vástago aislado 1000V - VDE
- Embalagem: Clipe Plástico | Packing: Plastic Clip | Embalaje: Clip Plástico

Chave de Fenda Especialista

Screwdriver | Llave de Ranura Especialista



Código	Descrição	KG	DIMENSÕES SIZE TAMAÑO (MM)				Quant. Min.
			A	B	C	D	
11616	5/16 X 6"	158g	45	250	40	120	12*
11620	1/4 X 1.1/2"	51g	45	100	35	240	12*
11638	5/16 X 6"	156g	45	250	40	120	12*
11640	1/4 X 1	49g	45	100	35	240	12*



Jogo de Chaves Fenda / Phillips

Phillips / Screwdrivers Set | Juego de Llaves Destornillador / Phillips



Código	Descrição	KG	DIMENSÕES SIZE TAMAÑO (MM)				Quant. Min.
			A	B	C	D	
11782	SL/PH	483g	200	310	35	30	15

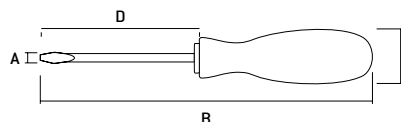

- Cabo anatômico | Anatomical cable | Mango anatómico
- Cabo emborrachado de dois componentes | Two-component rubberized cable | Mango de goma de dos componentes
- Ponta Imantada | Magnetized Tip | Puntada magnetizada

CHAVE CORRESPONDENTE CORRESPONDING KEY CLAVE CORRESPONDENTE	A	B	D
SL 4	4,0	200	100
SL 5	4,0	200	100
SL 6	4,0	250	150
PH 0	4,0	200	80
PH 1	4,0	200	100
PH 2	4,0	250	150

Chaves Fenda / Phillips Série CABO VERDE

Screwdrivers / Phillips Series Green Cable

Llaves Destornillador / Phillips - Serie Cabo verde

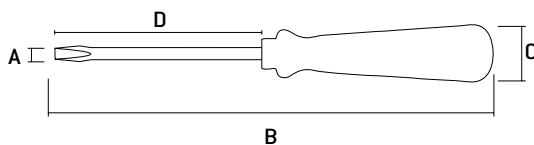

- Cabo anatômico | Anatomical cable | Cable anatómico
- Cabo plástico de dois componentes | Two-component rubberized cable | Cable de goma de dos componentes
- Embalagem: Clipe Plástico | Packing: Plastic Clip | Embalaje: Clip Plástico

Código	Tamanho	DIMENSÕES SIZE TAMAÑO (MM)				Quant. Min.	
		A	B	C	D		
1140155	1/8" X 3.1/8" (SL3 X 80 MM)	3	150	15	80	240	12
1140255	1/8" X 4" (SL3 X 100 MM)	3	200	15	100	240	12
1140355	1/8" X 5" (SL3 X 125 MM)	3	225	15	125	240	12
1140455	1/8" X 6" (SL3 X 150 MM)	3	250	15	150	240	12
1140555	3/16" X 1.1/2" (SL5 X 38 MM)	5	100	18	38	240	12
1140655	3/16" X 3" (SL5 X 75 MM)	5	160	18	75	240	12
1140755	3/16" X 6" (SL5 X 150 MM)	5	260	18	150	240	12
1140855	1/4" X 1.1/2" (SL6 X 38 MM)	6	100	25	38	240	12
1140955	1/4" X 4" (SL6 X 100 MM)	6	200	25	100	240	12
1141055	1/4" X 5" (SL6 X 125 MM)	6	225	25	125	240	12
1141155	1/4" X 6" (SL6 X 150 MM)	6	250	25	150	240	12
1141255	1/4" X 8" (SL6 X 200 MM)	6	300	25	200	120	12
1141355	1/4" X 10" (SL6 X 250 MM)	6	350	25	250	120	12
1141455	5/16" X 5" (SL8 X 125 MM)	8	225	25	125	120	12
1141555	5/16" X 6" (SL8 X 150 MM)	8	250	25	150	120	12
1141655	5/16" X 8" (SL8 X 200 MM)	8	300	25	200	120	12
1141755	5/16" X 10" (SL8 X 250 MM)	8	350	25	250	120	12
1141855	3/8" X 6" (SL9,5 X 150 MM)	9.5	250	25	150	120	12
1141955	3/8" X 8" (SL9,5 X 200 MM)	9.5	300	25	200	120	12
1142055	3/8" X 10" (SL9,5 X 250 MM)	9.5	350	25	250	120	12
1145155	1/8" X 2" (PH0 X 50 MM)	0	100	15	50	240	12
1145255	1/8" X 3" (PH0 X 75 MM)	0	150	15	75	240	12
1145355	1/8" X 5" (PH0 X 125 MM)	0	225	15	125	240	12
1145455	1/8" X 6" (PH0 X 150 MM)	0	250	15	150	240	12
1145555	3/16" X 1.1/2" (PH1 X 38 MM)	1	43	18	38	240	12
1145655	3/16" X 3" (PH1 X 75 MM)	1	150	18	75	240	12
1145755	3/16" X 4" (PH1 X 100 MM)	1	200	18	100	240	12
1145855	3/16" X 6" (PH1 X 150 MM)	1	250	18	150	240	12
1145955	1/4" X 1.1/2" (PH2 X 38 MM)	2	100	25	38	240	12
1146055	1/4" X 4" (PH2 X 100 MM)	2	200	25	100	240	12
1146155	1/4" X 5" (PH2 X 125 MM)	2	225	25	125	240	12
1146255	1/4" X 6" (PH2 X 150 MM)	2	250	25	150	240	12
1146355	5/16" X 6" (PH3 X 150 MM)	3	250	25	150	120	12
1146455	5/16" X 8" (PH3 X 200 MM)	3	300	25	200	120	12
1146555	3/8" X 6" (PH4 X 150 MM)	4	250	25	150	120	12
1146655	3/8" X 8" (PH4 X 200 MM)	4	300	25	200	120	12

Chaves Fenda / Phillips Série Point

Screwdrivers / Key Phillips - Point Series |

Llaves Destornillador / Phillips - Serie Point

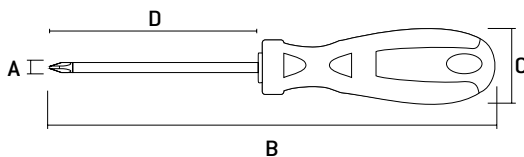

- Cabo anatômico | Anatomical cable | Cable anatómico
- Cabo emborrachado de dois componentes | Two-component rubberized cable | Cable de goma de dos componentes
- Embalagem: Clipe Plástico | Packing: Plastic Clip | Embalaje: Clip Plástico

Código	Tamanho	DIMENSÕES SIZE TAMAÑO (MM)				Quant. Min.	
		A	B	C	D		
1176055	1/8" X 2" (SL3 X 50 MM)	3	100	25	50	240	12
1176155	1/8" X 3" (SL3 X 75 MM)	3	150	25	75	240	12
1176255	1/8" X 4" (SL3 X 100 MM)	3	200	25	100	240	12
1176355	1/8" X 5" (SL3 X 125 MM)	3	225	25	125	240	12
1176455	1/8" X 6" (SL3 X 150 MM)	3	250	25	150	240	12
1176555	3/16" X 1.1/2" (SL5 X 38 MM)	5	100	25	38	240	12
1176655	3/16" X 3" (SL5 X 75 MM)	5	150	25	75	240	12
1176755	3/16" X 4" (SL5 X 100 MM)	5	200	25	100	192	12
1176855	3/16" X 5" (SL5 X 125 MM)	5	225	25	125	192	12
1176955	3/16" X 6" (SL5 X 150 MM)	5	250	25	150	192	12
1177055	1/4" X 1.1/2" (SL6 X 38 MM)	6	100	25	38	192	12
1177155	1/4" X 4" (SL6 X 100 MM)	6	200	25	100	192	12
1177255	1/4" X 5" (SL6 X 125 MM)	6	225	25	125	192	12
1177355	1/4" X 6" (SL6 X 150 MM)	6	250	25	150	192	12
1177455	1/4" X 8" (SL6 X 200 MM)	6	300	25	200	192	12
1177555	5/16" X 6" (SL8 X 150 MM)	8	250	25	150	144	12
1177655	5/16" X 8" (SL8 X 200 MM)	8	300	25	200	144	12
1177755	5/16" X 10" (SL8 X 250 MM)	8	350	25	250	144	12
1177855	3/8" X 6" (SL9,5 X 150 MM)	9.5	250	25	150	144	12
1177955	3/8" X 8" (SL9,5 X 200 MM)	9.5	300	25	200	144	12
1178055	3/8" X 10" (SL9,5 X 250 MM)	9.5	350	25	250	144	12
1178155	1/8" X 2" (PH0 X 50 MM)	0	130	25	50	240	12
1178255	1/8" X 3" (PH0 X 75 MM)	0	160	25	75	240	12
1178355	1/8" X 5" (PH0 X 125 MM)	0	210	25	125	240	12
1178455	1/8" X 6" (PH0 X 150 MM)	0	230	25	150	240	12
1178555	3/16" X 1.1/2" (PH1 X 38 MM)	1	160	25	38	240	12
1178655	3/16" X 3" (PH1 X 75 MM)	1	210	25	75	192	12
1178755	3/16" X 4" (PH1 X 100 MM)	1	190	25	100	192	12
1178855	3/16" X 6" (PH1 X 150 MM)	1	240	25	150	192	12
1178955	1/4" X 1.1/2" (PH2 X 38 MM)	2	100	25	38	240	12
1179055	1/4" X 4" (PH2 X 100 MM)	2	200	25	100	192	12
1179155	1/4" X 5" (PH2 X 125 MM)	2	220	25	125	192	12
1179255	1/4" X 6" (PH2 X 150 MM)	2	250	25	150	192	12
1179355	5/16" X 6" (PH3 X 150 MM)	3	260	25	150	144	12
1179455	5/16" X 8" (PH3 X 200 MM)	3	310	25	200	144	12
1179555	3/8" X 6" (PH4 X 150 MM)	4	260	25	150	144	12
1179655	3/8" X 8" (PH4 X 200 MM)	4	290	25	200	144	12

Chave Teste 140mm

Teste Key 140mm | Llave Test 140mm



antigo	novo			DIMENSÕES SIZE TAMAÑO (MM)		
130405	1304055	100V a 500V	12g	A	1200	20

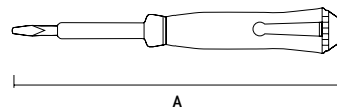

- Haste niquelada | Nickel plated rod | Vástago niquelado
- Capacidade 100V a 500V | Capacity 100V to 500V | Capacidad 100V a 500V
- Não indicada para soltar ou apertar parafusos | Not suitable for loosening or tightening screws | No indicado para soltar o apertar tornillos

Chave Teste 190mm

Teste Key 190mm | Llave Test 190mm



antigo	novo			DIMENSÕES SIZE TAMAÑO (MM)		
130605	1306055	100V a 500V	20g	A	1200	20

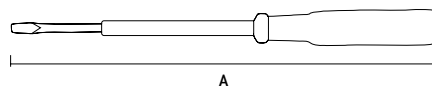

- Haste niquelada | Nickel plated rod | Vástago niquelado
- Capacidade 100V a 500V | Capacity 100V to 500V | Capacidad 100V a 500V
- Não indicada para soltar ou apertar parafusos | Not suitable for loosening or tightening screws | No indicado para soltar o apertar tornillos

Multiteste Digital LCD

Multitest Digital LCD | Multifunción Digital LCD



				DIMENSÕES SIZE TAMAÑO (MM)		
1308055	Medições 12V - 220V			A	500	20

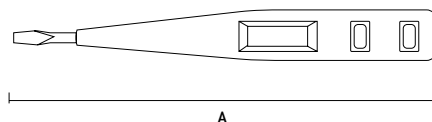

- Escala de medição 12V-220V | Measuring range 12V-220V | Escala de medición 12V-220V
- Medições de tensão (V) e verificação de polaridade | Voltage measurements (V) and polarity check | Mediciones de tensión (V) y verificación de polaridad
- Display LCD | LCD Display | Pantalla LCD
- Não indicada para soltar ou apertar parafusos | Not suitable for loosening or tightening screws | No indicado para soltar o apertar tornillos

Multiteste Digital LCD led

Multitest Digital LCD led | Multifunción Digital LCD led



				DIMENSÕES SIZE TAMAÑO (MM)		
130855	1308555			A	500	20



• Medições CA e CC 12V, 36V, 55V, 110V e 220V

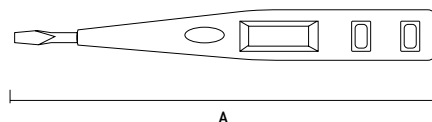

- DIN VDE 0680 Teil 6 04.77 e norma europeia CE. | DIN VDE 0680 Teil 6 04.77 and European standard CE. | DIN VDE 0680 Teil 6 04.77 y norma europea CE.
- O Multiteste digital foi projetado para detecção de tensão nas redes elétricas, verificação do estado e polaridade das baterias e pilhas secas, verificação de fios para detectar a descontinuidade, detecção de micro-ondas e radiação eletromagnética. | The Digital Multiteste is designed for voltage detection in electrical networks, verification of the state and polarity of batteries and dry batteries, wires to detect discontinuity, microwave detection and electromagnetic radiation. | El Multiteste digital está diseñado para la detección de tensión en las redes eléctricas, la verificación del estado y la polaridad de las baterías y las pilas secas, hilos para detectar la discontinuidad, la detección de microondas y la radiación electromagnética.
- Visor Digital e lâmpada neon | Digital display and neon lamp | Pantalla digital y lámpara de neón
- Não indicada para soltar ou apertar parafusos | Not suitable for loosening or tightening screws | No indicado para soltar o apertar tornillos

Jogo de Chaves de Precisão 6pçs

Precision Key Set 6pcs | Juego de llaves de precisión 6pzs



antigo	novo			
133445	1334455	PH/SL	100	Quant. Min. 6

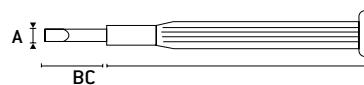

- Ideal para manutenção de relógios, óculos e componentes eletrônicos | Ideal for maintenance of watches, glasses and electronic components | Ideal para el mantenimiento de relojes, gafas y componentes electrónicos

CHAVE CORRESPONDENTE CORRESPONDING KEY CLAVE CORRESPONDENTE	KG	DIMENSÕES SIZE TAMAÑO (MM)		
		A	B	C
SL1,4	5g	1.4	22	58
SL2,0	6g	2.0	22.5	65
SL2,4	7g	2.4	26	68
SL3,0	12g	3.0	28	75
PH00	7g	2.4	24.5	70
PH0	11g	3.0	30	75

Jogo de Chaves de Precisão imantado - 8pçs

Precision Key Set magnetized - 8pcs | Juego de llaves de precisión imantado - 8pzs

115899	SL, PH, TR	371g	DIMENSÕES SIZE TAMAÑO (MM)			
			A	B	48	Quant. Min. 6

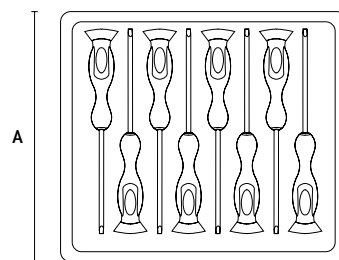

Composição | Composition | composición:
SL2,0 | SL2,4 | SL3,0 | PH00 | PH0 | TR 5 | TR 6

- Aço CrV | Stel CrV | Acero CrV
- Ideal para manutenção de relógios, óculos e componentes eletrônicos | Ideal for maintenance of watches, glasses and electronic components | Ideal para el mantenimiento de relojes, gafas y componentes electrónicos

Jogo de Chaves de Precisão 6pçs

Precision Key Set 6pcs | Juego de llaves de precisión 6pzs



antigo	novo			
13346	1334666	PH/SL	96	Quant. Min. 12

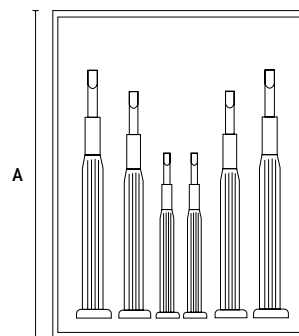

Composição | Composition | composición:
SL1,4 | SL2,0 | SL2,4 | PH00 | PH0 | PH1

- Aço CrMo | Stel CrMo | Acero CrMo
- Ferramenta de alta precisão | High precision tool | Herramienta de alta precisión
- Uso industrial | Industrial use | Uso industrial
- Ideal para manutenção de relógios, óculos e componentes eletrônicos | Ideal for maintenance of watches, glasses and electronic components | Ideal para el mantenimiento de relojes, gafas y componentes electrónicos

Jogo de Ferramentas para Bancada 6pçs

Bench Top Tool Set 6pcs | Juego de herramientas para banco 6pzs



6 peças
parts | piezas



antigo	novo	Quant. Min.
13540	1354055	20

COMPOSIÇÃO COMPOSITION COMPOSICIÓN	KG	DIMENSÕES SIZE TAMAÑO (MM)		
		A	B	C
1 MARTELO HAMMER MARTILLO	298g	100	285	20
1 ALICATE PLIERS ALICATE	174g	100	160	10
1 TRENA MEASURING TAPE CINTA MÉTRICA	50g	56	57	2MT
1 CHAVE DE FENDA SCREWDRIVER DESTORNILLADOR	174g	2.9	47	87
1 CHAVE PHILLIPS PHILLIPS SCREWDRIVER LLAVE PHILLIPS	174g	4.9	65	87
1 ESTILETE STILETTO CUCHILLO	174g	40	150	15

- Indicada para pequenos trabalhos do dia a dia | Suitable for everyday small jobs | Indicada para pequeños trabajos del día a día

Jogo de Ferramentas de montagem 40pçs

Mounting Tools Set 40pcs | Juego de herramientas de montaje 40pzs



40 peças
parts | piezas

Composição | Composition | composición:

- 8 bits
- 26 cabeçotes terminais | endheads | cabezas terminales
- 1 chave de catraca | ratchet wrench | llave de trinquete
- 1 cabo de extensão | extension cable | cable de extensión
- 1 adaptador de bit | bit adapter | adaptador de bits
- 1 chave de fenda quadrada | square screwdriver | destornillador cuadrado

13565	850g	DIMENSÕES SIZE TAMAÑO (MM)			Quant. Min.
		A	B	C	
		195	420	62	24

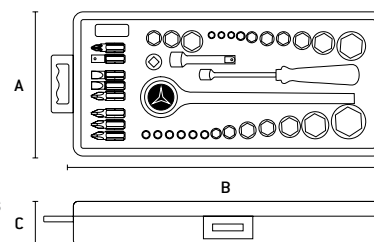

Jogo de Ferramentas para Bancada 129pçs

Bench Top Tool Set 129pcs | Juego de herramientas para banco 129pzs



129 peças
parts | piezas



13564	2450g	6	1
-------	-------	---	---



Composição | Composition | composición:

- 1 alicate bico meia cana reto 6" (160mm) | Snipe Nose Pliers | Pinza Punta Media Caña
- 1 alicate corte diagonal 6" (160mm) | diagonal cutting pliers | Pinza corte diagonal
- 1 alicate prensa terminais | pliers terminal presses | alicate prensa terminales
- Jogo com 20 bits: | Game with bits | Juego con bits
(Hex H3 - H4 - H5 - H6 mm)
(Quadrado S1 - S2 | Sqaurel cuadrado);
(Adaptador | Adapter);
(Torx T10 - T15 - T20 - T25);
(Pozi driv 0-1-2);
(Phillips 1-2-3);
(Fenda 3-4-5)
- Jogo com 16 chave Allen: | Set with Allen wrench | Juego con llave Allen
(1,5 - 2 - 2,5 - 3 - 4 - 5 - 5,5 - 6mm);
(1/16" - 5/64" - 3/32" - 1/8" - 5/32" - 3/16" - 7/32" - 1/4")
- Cabo anatómico com catraca para bits | Anatomical cable with ratchet for bits | Cable anatómico con trinquete para bits
- 4 chaves de precisão | precision wrenches | llaves de precisión
- Chaves ajustáveis / inglesa 6" (150mm) | Adjustable wrenches / English | Llaves ajustables / inglés
- Estilete | Styllet 9mm
- Martelo unha 250g cabo metálico emborrachado | Nail hammer rubberized metallic handle | Martillo uña cable metálico de goma
- Nível 9" (230mm) com 3 bolhas | Level 9" (230mm) with 3 bubbles | Nivel 9" (230mm) con 3 burbujas
- 10 parafusos 6mm, cabeça chata zincado Phillips | Phillips 6mm Screws, Phillips Galvanized Flat Head | tornillos 6mm, cabeça plana zincado Phillips
- 46 pregos de aço com cabeça 20mm | steel studs with head 20mm | clavos de acero con cabeza 20mm
- 5 parafusos máquina cabeça redonda com porca sextavada | round head machine screws with hex nut | tornillos máquina cabeça redonda con tuerca hexagonal
- 4 ganchos | hooks
- 10 buchas plásticas para fixação 6mm | plastic bushings for fastening 6mm | Buchas plásticas para fijación 6mm
- Trena 3,5m x 12mm | measuring tape | cinta métrica
- Maleta plástica | Plastic suitcase |

Chave Inglesa Cromada

Chrome Plated Wrench | Llave Inglesa Cromada



antigo	novo	mm	DIMENSÕES SIZE TAMAÑO (MM)				Quant. Min.	
			A	B	C	D		
155205	1552055	6" (150 mm)	60	150	5	19	120	6
	1552555	8" (200 mm)	70	240	5	24	120	6
	1553055	10" (250 mm)	70	250	5	30	60	6
155355	1553555	12" (300 mm)	70	310	5	36	48	6
155405	1554055	15" (375 mm)	87	370	24	46	24	6
155455	1554555	18" (450 mm)	120	470	50	50	12	6

AUTO SERVIÇO

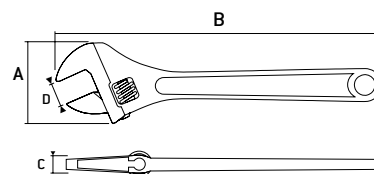

- Indicada para fixar ou soltar porcas e parafusos quadrados e sextavados | Suitable for tightening or loosening square and hexagonal nuts and bolts | Indicada para apretar o soltar tuercas y tornillos cuadrados y hexagonales

Chave Inglesa cabo emborrachado

Wrench Rubber Cable | Llave de cable de cobre



	mm	mm	DIMENSÕES SIZE TAMAÑO (MM)				Quant. Min.
			A	B	C	D	
155019	6" (150 mm)	86	235	13	12	48	6
155039	8" (200 mm)	105	270	15	19	36	6
155059	10" (250 mm)	111	333	17	16	24	6
155079	12" (300 mm)	115	383	20	20	24	6
155119	18" (450 mm)	188	535	26	32	10	1



BLISTER

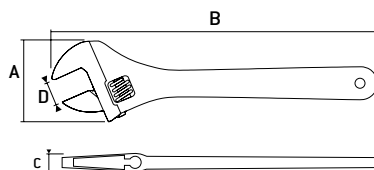

- Indicada para fixar ou soltar porcas e parafusos quadrados e sextavados | Suitable for tightening or loosening square and hexagonal nuts and bolts | Indicada para apretar o soltar tuercas y tornillos cuadrados y hexagonales
- Cabeça polida | Polished head | Cabeza pulida
- Aço Carbono | Carbon steel | Acero carbono

Escala em milímetro para determinar a abertura
Scale in millimeter to determine aperture
Escala en milímetro para determinar la apertura



Chave de grifo tipo "S"

Pipe wrench type "S" | Clave de grifo tipo "S"



	mm	DIMENSÕES SIZE TAMAÑO (MM)			Quant. Min.	
		A	B	C		
156339	nº 3-2"	80	565	25	12	1*

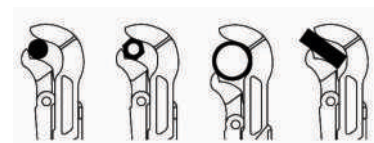
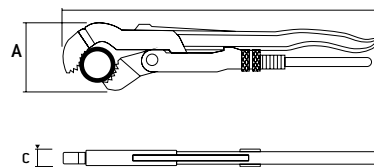

- Tipo Sueca | Swedish type | Tipo Sueca
- Para Tubos | For Tubes | Para Tubos
- Uso Profissional | Professional Use | Uso Profesional
- Embalagem: caixa individual | Packing: single box | Embalaje: caja individual

Chave de grifo Modelo Heavy Duty

Pipe wrench Heavy Duty Model | Llave de grifo Modelo Heavy Duty



- Tipo Americano | American type | Tipo Americano
- Uso Industrial | Industrial use | Uso Industrial
- Mordente em aço | Steel chevron | Mordente de acero

Código	Tamanho	DIMENSÕES SIZE TAMAÑO (MM)				Quant. Min.	
		A	B	C	D		
1570155	8" (200 mm)	50	200	20	40	72	1
1570255	10" (250 mm)	60	250	20	50	48	1
1570355	12" (300 mm)	70	300	20	60	36	1
1570455	14" (350 mm)	75	350	20	70	24	1
1570555	18" (450 mm)	90	457	35	80	12	1
1570655	24" (600 mm)	95	600	30	90	10	1
1570755	36" (900 mm)	130	900	40	100	6	1

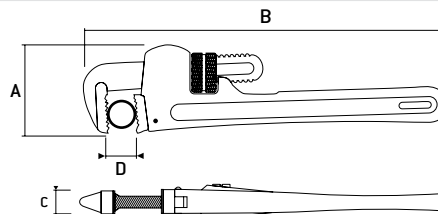

Chave de grifo em alumínio

Griffin key aluminum | Llave de grifo de aluminio



- Corpo em alumínio, super leve e altamente resistente | Super light and highly resistant aluminum body | Cuerpo en aluminio, súper ligera y altamente resistente
- Tipo Americano | American type | Tipo Americano
- Para Tubos | For Tubes | Para Tubos
- Uso Profissional | Professional Use | Uso Profesional

Código	Tamanho	DIMENSÕES SIZE TAMAÑO (MM)				Quant. Min.	
		A	B	C	D		
1560155	10" (250 mm)	56	250	20	50	48	1
1560255	12" (300 mm)	60	300	20	60	36	1
1560355	14" (350 mm)	80	350	25	70	24	1
1560455	18" (450 mm)	90	457	40	80	12	1
1560555	24" (600 mm)	100	600	30	90	10	1
1560655	36" (900 mm)	120	900	40	100	6	1

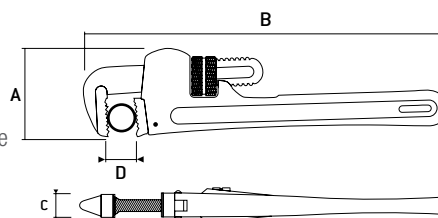

Chave de grifo tipo Stillson

Pipe wrench Type Stillson | Llave de grifo tipo Stillson



- Para Tubos | For Tubes | Para Tubos
- Uso Profissional | Professional Use | Uso Profesional

Código	Tamanho	Peso	DIMENSÕES SIZE TAMAÑO (MM)				Quant. Min.	
			A	B	C	D		
157565	10" (250 mm)	504g	68	230	15,5	50,8	48	6
157645	12" (300 mm)	977g	76	300	18	63,5	24	4
157685	18" (450 mm)	1456g	100	460	18	83,5	18	1

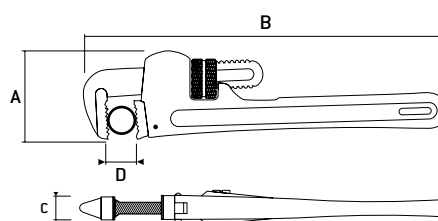

Chave de grifo Inclinado

Inclined Griffin key | Llave de grifo Inclinado



- Facilita o acesso nos lugares difíceis | Facilitates access in difficult places | Facilita el acceso en lugares difíciles
- Tipo Americano | American type | Tipo Americano
- Mordente em aço | Steel chevron | Mordente de acero
- Uso Profissional | Professional Use | Uso Profesional

Código	Tamanho	DIMENSÕES SIZE TAMAÑO (MM)				Quant. Min.	
		A	B	C	D		
1571155	8" (200 mm)	45	200	20	40	48	1
1571255	10" (250 mm)	60	250	20	50	36	1
1571355	12" (300 mm)	65	300	30	60	24	1
1571455	14" (350 mm)	80	350	20	70	24	1
1571555	18" (450 mm)	90	457	30	80	12	1
1571655	24" (600 mm)	110	600	40	90	10	1
1571755	36" (900 mm)	130	900	50	100	4	1

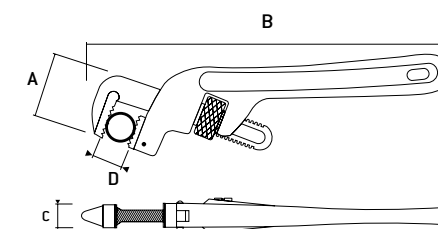

Jogo de Limas Agulha Diamantadas - 5 pçs

Set of Diamond Needle Files | Juego de limas Aguja Diamantada

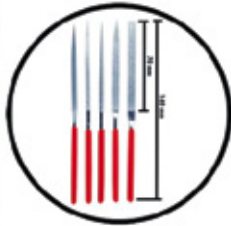

5 peças
parts | piezas

158339	140x70x3mm	DIMENSÕES SIZE TAMAÑO (MM)		200	20
		A	B		

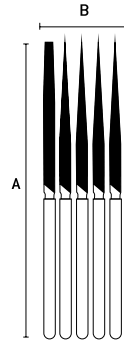

- Ideal para afiação de ferramentas com Wídea | Ideal for tool edging with Wídea | Ideal para afinación de herramientas con Wídea
- Indicada para ourives e pessoas que trabalhem com pequenas peças | Indicated for goldsmiths and people who work with small parts | Indicada para orillos y personas que trabajen con pequeñas piezas
- Embalagem: Plástica | Packing: Plastic | Embalaje: Plástico

Lima Formato Plano

Flat Scraper | Raspador plano



1622055	4" (100 mm)	DIMENSÕES SIZE TAMAÑO (MM)		72	12
		A	B		
1622355	6" (150 mm)	15	270	72	12
1622655	8" (200 mm)	52	310	72	12
1622955	10" (250 mm)	25	390	72	12
1623255	12" (300 mm)	55	440	48	12

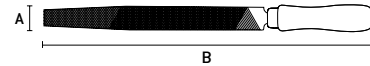

- Murça | Murça | Murça
- Cabo de Madeira | Wooden Cape | Cable de madera

Lima Formato Triangular

Triangular shape scraper | Rascador Formato Triangular



1602055	4" (100 mm)	DIMENSÕES SIZE TAMAÑO (MM)		72	12
		A	B		
1602355	6" (150 mm)	50	260	72	12
1602655	8" (200 mm)	50	310	72	12
1602955	10" (250 mm)	50	370	72	12
1603255	12" (300 mm)	55	450	48	12

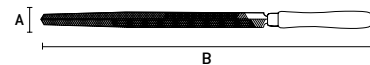

- Murça | Murça | Murça
- Cabo de Madeira | Wooden Cape | Cable de madera

Lima Formato Meia Cana

Half Cane Scraper | Rascador Formato Medias Cana



1632055	4" (100 mm)	DIMENSÕES SIZE TAMAÑO (MM)		72	12
		A	B		
1632355	6" (150 mm)	40	260	72	12
1632655	8" (200 mm)	53	322	72	12
1632955	10" (250 mm)	55	392	72	12
1633255	12" (300 mm)	54	453	48	12

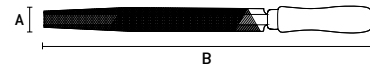

- Murça | Murça | Murça
- Cabo de Madeira | Wooden Cape | Cable de madera

Lima Formato Redondo

Round Scraper | Rascador Formato Redondo



1612055	4" (100 mm)	DIMENSÕES SIZE TAMAÑO (MM)		72	12
		A	B		
1612355	6" (150 mm)	50	260	72	12
1612655	8" (200 mm)	100	310	72	12
1612955	10" (250 mm)	100	180	72	12
1613255	12" (300 mm)	55	436	48	12



- Murça | Murça | Murça
- Cabo de Madeira | Wooden Cape | Cable de madera



Lima Formato Triangular



Barcode	Size	DIMENSÕES SIZE TAMAÑO (MM)		Box	Quant. Min.
		A	B		
1603355	4" (100 mm)	50	200	72	12
1603455	6" (150 mm)	50	260	72	12
1603555	8" (200 mm)	50	310	72	12
1603655	10" (250 mm)	50	370	72	12
1603755	12" (300 mm)	55	450	48	12



- Bastarda | Bastard | Bastardo
- Cabo de Madeira | Wooden Cape | Cable de madera

Lima Formato Redondo



Barcode	Size	DIMENSÕES SIZE TAMAÑO (MM)		Box	Quant. Min.
		A	B		
1613355	4" (100 mm)	50	200	72	12
1613455	6" (150 mm)	50	260	72	12
1613555	8" (200 mm)	10	310	72	12
1613655	10" (250 mm)	10	380	72	12
1613755	12" (300 mm)	55	436	48	12



- Bastarda | Bastard | Bastardo
- Cabo de Madeira | Wooden Cape | Cable de madera

Lima Formato Plano



Barcode	Size	DIMENSÕES SIZE TAMAÑO (MM)		Box	Quant. Min.
		A	B		
1623355	4" (100 mm)	52	200	72	12
1623455	6" (150 mm)	52	270	72	12
1623555	8" (200 mm)	52	310	72	12
1623655	10" (250 mm)	25	390	72	12
1623755	12" (300 mm)	55	440	48	12

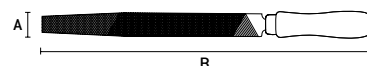

- Bastarda | Bastard | Bastardo
- Cabo de Madeira | Wooden Cape | Cable de madera

Lima Formato Meia Cana



Barcode	Size	DIMENSÕES SIZE TAMAÑO (MM)		Box	Quant. Min.
		A	B		
1633355	4" (100 mm)	40	200	72	12
1633455	6" (150 mm)	40	260	72	12
1633555	8" (200 mm)	53	322	72	12
1633655	10" (250 mm)	55	392	72	12
1633755	12" (300 mm)	54	453	48	12

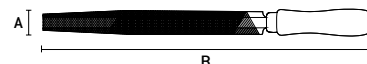

- Bastarda | Bastard | Bastardo
- Cabo de Madeira | Wooden Cape | Cable de madera

Lima Formato Triangular



1584255	8" (200 mm)	DIMENSÕES SIZE TAMARO (MM)		72	12
		A	B		



- Murça | Murça | Murça
- Cabo plástico | plastic cable | cable de plástico

Lima Formato Redonda



1584655	8" (200 mm)	DIMENSÕES SIZE TAMARO (MM)		72	12
		A	B		



- Murça | Murça | Murça
- Cabo plástico | plastic cable | cable de plástico

Lima Formato Quadrada



1584455	8" (200 mm)	DIMENSÕES SIZE TAMARO (MM)		72	12
		A	B		



- Murça | Murça | Murça
- Cabo plástico | plastic cable | cable de plástico

Lima Formato Chata



1584155	8" (200 mm)	DIMENSÕES SIZE TAMARO (MM)		72	12
		A	B		



- Murça | Murça | Murça
- Cabo plástico | plastic cable | cable de plástico

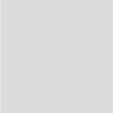

Lima Formato Meia-Cana



1584855	8" (200 mm)	DIMENSÕES SIZE TAMAÑO (MM)		72	12
		A	B		



- Murça | Murça | Murça
- Cabo plástico | plastic cable | cable de plástico

Jogo De Limas Bastardas 3 pçs



1585255	8" (200 mm)	DIMENSÕES SIZE TAMAÑO (MM)		72	12
		A	B		

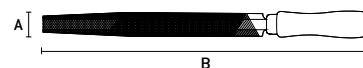

- Bastarda | Bastard | Bastardo
- Cabo plástico | plastic cable | cable de plástico

Jogo De Limas Bastardas 5 pçs



1585455	8" (200 mm)	DIMENSÕES SIZE TAMAÑO (MM)		72	12
		A	B		

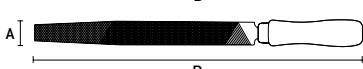

- Bastarda | Bastard | Bastardo
- Cabo plástico | plastic cable | cable de plástico

Mandril Aperto Rápido

Fast Clamp Chuck | Mandril Apriete Rápido



168089	Rosca 1/2", 1-10mm	189g	DIMENSÕES SIZE TAMAÑO (MM)		50	80	50	1
			A	B				

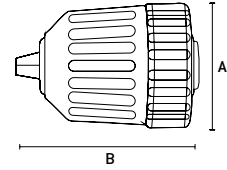

- Não utiliza chave | Does not use a key | No utiliza clave
- Embalagem: Caixa | Packing: Box | Embalaje: Caja

Mandril Auto Lock

Auto Lock Chuck | Mandril Auto Lock



168059	Rosca 1/2", 1-10mm	228g	DIMENSÕES SIZE TAMAÑO (MM)		50	80	50	1
			A	B				
168079	Rosca 1/2", 2-13mm	325g	50	80	50	50	1	

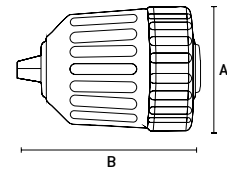

- APERTO RÁPIDO | QUICK START | APERTURA RÁPIDA
- Função Auto Lock (trava de segurança para evitar o desbloqueio da broca) | Auto Lock function (safety lock to prevent unlocking of the drill bit) | Función Auto Lock (bloqueo de seguridad para evitar el desbloqueo de la broca)
- Não utiliza chave | Does not use a key | No utiliza clave
- Embalagem: Caixa | Packing: Box | Embalaje: Caja

SISTEMA EXCLUSIVO MTX
MTX EXCLUSIVE SYSTEM
SISTEMA EXCLUSIVO MTX

Mandril de Chave Manual

Manual Switch Chuck | Mandril de llave manual



168179	Rosca 1/2", 1,5-13mm	335g	DIMENSÕES SIZE TAMAÑO (MM)		50	80	50	1
			A	B				
168189	Rosca 3/8", 1,5-13mm	361g	50	80	50	50	1	
168199	CONE b16, 3-16mm	617g	70	90	30	30	1	
168209	CONE b18, 3-16mm	647g	60	90	30	30	1	
168229	CONE b12, 1,5-13mm	364g	50	80	50	50	1	

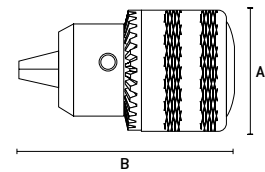

- Com furo passante | With through hole | Con agujero pasante
- Acompanha chave | Accompany key | Acompaña clave
- Embalagem: Caixa | Packing: Box | Embalaje: Caja

Chave para Mandril

Chuck wrench | Llave para Mandril



168859	Isolado Isolated Aislado - 10 mm	76	DIMENSÕES SIZE TAMAÑO (MM)			100	20
			A	B	C		
168899	Isolado Isolated Aislado - 13 mm	76	137	17	100	20	
168869	Isolado Isolated Aislado - 16 mm	75	135	25	80	16	
1689059	oxidado rusty oxidado - 10 mm	76	137	15	100	20	
1689559	oxidado rusty oxidado - 13 mm	76	137	20	100	20	



168859/168869/168899

- Isolado | Isolated | Aislado

1689059/1689559

- oxidado | rusty | oxidado

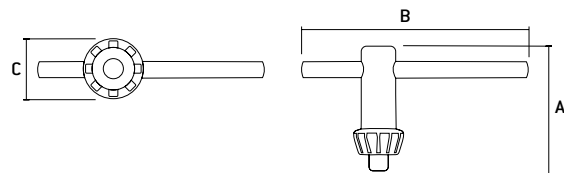

Mini Alicate Bico Meia-Cana Reto (125mm)

Pliers Beak Half-Cane Straight Mini | Pinza Punta Media-Canã Reto Mini



- Reforçado | Reinforced | Reforzado
- Acabamento Fosfatizado | Phosphated Finish | Acabado Fosfatizado

1783055	5" (125 mm)	109g	6
DIMENSÕES SIZE TAMAÑO (MM)			
A	B	C	
85	185	25	60

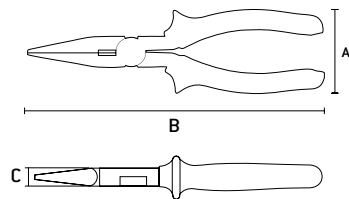

Mini Alicate Bico Meia-Cana Curvo (125mm)

Pliers Beak Half-Cane Curved Mini | Pinza Punta Media-Canã Curvo Mini



- Reforçado | Reinforced | Reforzado
- Acabamento Fosfatizado | Phosphated Finish | Acabado Fosfatizado

1783155	5" (125 mm)	109g	6
DIMENSÕES SIZE TAMAÑO (MM)			
A	B	C	
85	185	25	60

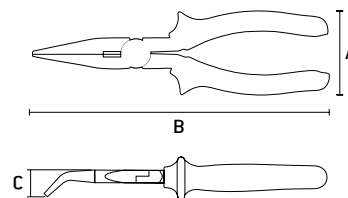

Mini Alicate Corte Diagonal (110mm)

Diagonal Cutting Pliers Mini | Pinza Corte Diagonal Mini



- Lâmina de corte temperada | Hardened cutting blade | Lámina de corte templada
- Reforçado | Reinforced | Reforzado
- Acabamento Fosfatizado | Phosphated Finish | Acabado Fosfatizado

1783255	4.1/2" (110 mm)	109g	6
DIMENSÕES SIZE TAMAÑO (MM)			
A	B	C	
85	185	25	60

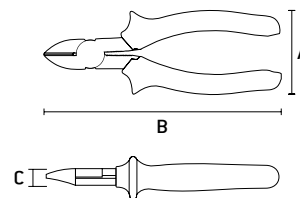

Mini Alicate Universal (120mm)

Universal pliers Mini | Alicate Universal Mini



- Reforçado | Reinforced | Reforzado
- Acabamento Fosfatizado | Phosphated Finish | Acabado Fosfatizado

1783355	4.3/4" (120 mm)	109g	6
DIMENSÕES SIZE TAMAÑO (MM)			
A	B	C	
85	185	25	60

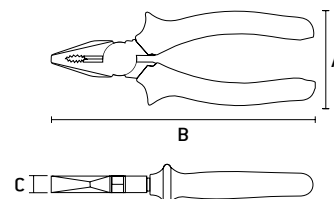

Mini Alicate Bico Meia-Cana Curvo Longo (150mm)

Mini Pliers Long Beak Medium Curved | Mini Pinza Punta Media-Canã Curvo Largo



			DIMENSÕES SIZE TAMAÑO (MM)					
1783455	6" (150 mm)	109g	A	B	C	60	6	

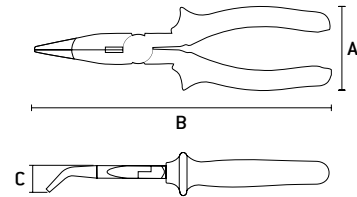

- Reforçado | Reinforced | Reforzado
- Acabamento Fosfatizado | Phosphated Finish | Acabado Fosfatizado

Mini Alicate Bico Redondo (127mm)

Mini Round Bead Pliers | Mini Pinza Punta Redonda



			DIMENSÕES SIZE TAMAÑO (MM)					
1783555	5" (125 mm)	109g	A	B	C	60	6	

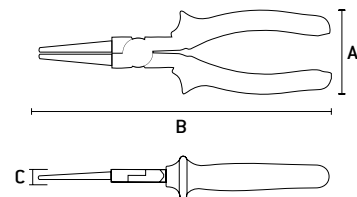

- Reforçado | Reinforced | Reforzado
- Acabamento Fosfatizado | Phosphated Finish | Acabado Fosfatizado

Mini Alicate Corte Frontal (105mm)

Mini Front Cutting Pliers | Mini Pinza Corte Frontal



			DIMENSÕES SIZE TAMAÑO (MM)					
1783755	4.1/2" (105 mm)	109g	A	B	C	60	6	

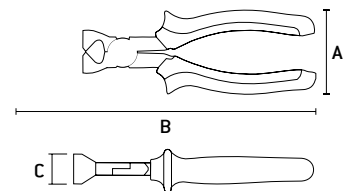

- Lâmina de corte temperada | Hardened cutting blade | Lámina de corte templada
- Reforçado | Reinforced | Reforzado
- Acabamento Fosfatizado | Phosphated Finish | Acabado Fosfatizado

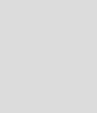

Mini Alicate Bico Meia-Cana Reto (125mm)

Pliers Beak Half-Cane Straight Mini | Pinza Punta Media-Canã Reto Mini



			DIMENSÕES SIZE TAMAÑO (MM)				
1719755	6.1/2" (125 mm)	109g	A	B	C	60	Quant. Min. 6

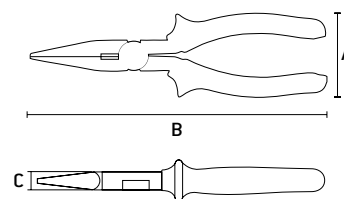

- Reforçado | Reinforced | Reforzado
- Acabamento Fosfatizado | Phosphated Finish | Acabado Fosfatizado

Alicate Corte Diagonal (150mm)

Diagonal Cutting Pliers | Pinza Corte Diagonal



			DIMENSÕES SIZE TAMAÑO (MM)				
1754855	6" (150 mm)	109g	A	B	C	60	Quant. Min. 6

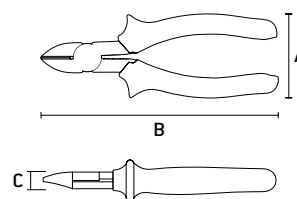

- Reforçado | Reinforced | Reforzado
- Acabamento Fosfatizado | Phosphated Finish | Acabado Fosfatizado

Alicate Universal Combinada

Universal Combination Pliers | Alicate Universal Combinado



			DIMENSÕES SIZE TAMAÑO (MM)				
1706155	8" (200 mm)	373g	A	B	C	60	Quant. Min. 6

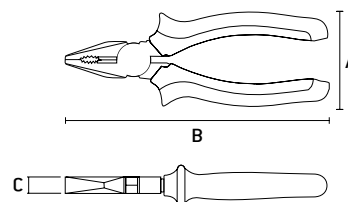

- Reforçado | Reinforced | Reforzado
- Acabamento Fosfatizado | Phosphated Finish | Acabado Fosfatizado

Alicate Bico Meia-Cana Reto Níckel

Pliers Beak Half-Cane Straight Nickel | Pinza Punta Media-Canã Reto Níckel



171649	6" (160 mm)	202g	DIMENSÕES SIZE TAMAÑO (MM)			60	6
			A	B	C		

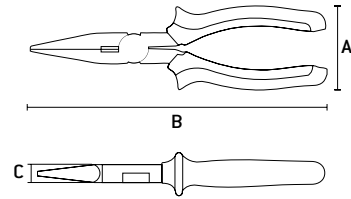

- Linha Níckel | Nickel Line | Línea Níckel
- Acabamento polido | Polished finish | Acabado pulido
- Cabo Plástico anatômico com dois componentes | Cable Anatomic plastic with two components | Mango plástico anatômico con dos componentes
- Embalagem: Clipe Plástico | Packing: Plastic Clip | Embalaje: Clip Plástico

Alicate Bico Meia-Cana Curvo Níckel

Pliers Beak Half-Cane Curved Nickel | Pinza Punta Media-Canã Curvo Níckel



174229	7" (180 mm)	245g	DIMENSÕES SIZE TAMAÑO (MM)			60	6
			A	B	C		

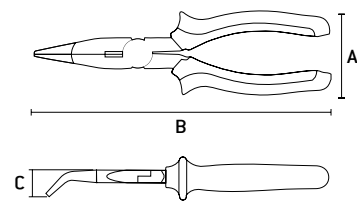

- Linha Níckel | Nickel Line | Línea Níckel
- Acabamento polido | Polished finish | Acabado pulido
- Cabo Plástico anatômico com dois componentes | Cable Anatomic plastic with two components | Mango plástico anatômico con dos componentes
- Embalagem: Clipe Plástico | Packing: Plastic Clip | Embalaje: Clip Plástico

Alicate Corte Diagonal Níckel

Diagonal Cutting Pliers Nickel | Pinza Corte Diagonal Níckel



175209	6" (160 mm)	225g	DIMENSÕES SIZE TAMAÑO (MM)			60	6
			A	B	C		
175229	7" (180 mm)	285g	64	242	27	60	6

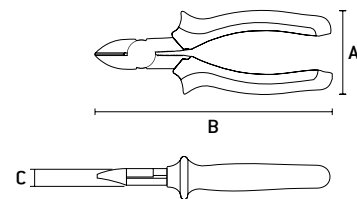

- Linha Níckel | Nickel Line | Línea Níckel
- Lâmina de corte temperada | Hardened cutting blade | Lámina de corte templada
- Acabamento polido | Polished finish | Acabado pulido
- Cabo Plástico anatômico com dois componentes | Cable Anatomic plastic with two components | Mango plástico anatômico con dos componentes
- Embalagem: Clipe Plástico | Packing: Plastic Clip | Embalaje: Clip Plástico

Alicate Universal Níckel

Universal pliers Nickel | Alicate Universal Níckel



169069	8" (200 mm)	365g	DIMENSÕES SIZE TAMAÑO (MM)			60	6
			A	B	C		

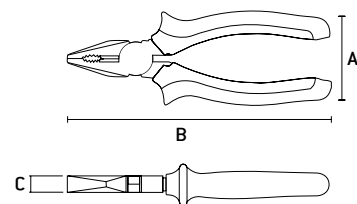

- Linha Níckel | Nickel Line | Línea Níckel
- Acabamento polido | Polished finish | Acabado pulido
- Cabo Plástico anatômico com dois componentes | Cable Anatomic plastic with two components | Mango plástico anatômico con dos componentes
- Embalagem: Clipe Plástico | Packing: Plastic Clip | Embalaje: Clip Plástico



1

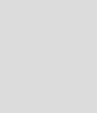

Alicate Bico Meia-Cana Reto Black Níckel

Pliers Beak Half-Cane Straight Black Nickel | Pinza Punta Media-Canã Reto Black Níckel



			DIMENSÕES SIZE TAMAÑO (MM)				
171589	6" (160 mm)	195g	A	B	C	60	6

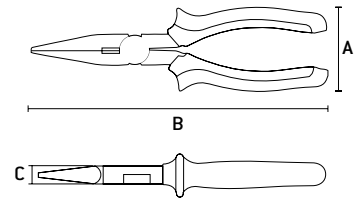

- Linha Black Níckel | Black Nickel Line | Línea Black Níckel
- Acabamento polido | Polished finish | Acabado pulido
- Cabo Plástico anatômico com dois componentes | Cable Anatomic plastic with two components | Cable plástico anatómico con dos componentes
- Embalagem: Clipe Plástico | Packing: Plastic Clip | Embalaje: Clip Plástico

Alicate Corte Diagonal Black Níckel

Diagonal Cutting Pliers Black Nickel | Pinza Corte Diagonal Black Níckel



			DIMENSÕES SIZE TAMAÑO (MM)				
175729	6" (160 mm)	222g	A	B	C	60	6
175749	7" (180 mm)	273g	64	248	25	60	6

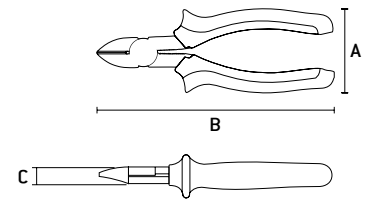

- Linha Black Níckel | Black Nickel Line | Línea Black Níckel
- Acabamento polido | Polished finish | Acabado pulido
- Cabo Plástico anatômico com dois componentes | Cable Anatomic plastic with two components | Cable plástico anatómico con dos componentes
- Embalagem: Clipe Plástico | Packing: Plastic Clip | Embalaje: Clip Plástico

Alicate Universal Níckel

Universal pliers Nickel | Alicate Universal Nickel



			DIMENSÕES SIZE TAMAÑO (MM)				
169789	6" (160 mm)	243g	A	B	C	60	6
169839	8" (200 mm)	363g	60	250	20	60	6

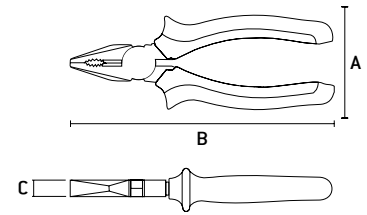

- Linha Black Níckel | Black Nickel Line | Línea Black Níckel
- Acabamento polido | Polished finish | Acabado pulido
- Cabo Plástico anatômico com dois componentes | Cable Anatomic plastic with two components | Cable plástico anatómico con dos componentes
- Embalagem: Clipe Plástico | Packing: Plastic Clip | Embalaje: Clip Plástico

Removedor para anéis de pressão com bicos

Pressure Ring Remover with Nozzles | Eliminador para anillos de presión con boquillas



			DIMENSÕES SIZE TAMAÑO (MM)				
183505	1835055	6" (150 mm)	175g	A	B	48	6

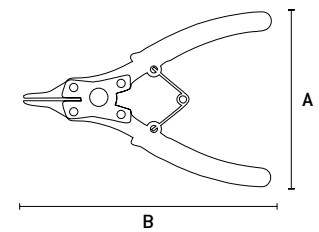

- Para anéis de retenção internos e externos (furos) | For internal and external retaining rings (holes) | Para anillos de retención internos y externos (agujeros)
- Bicos retos e curvos | Straight and curved nozzles | Boquillas rectas y curvas
- Acabamento fosfatizado | Phosphatized Finish | Acabado fosfatizado
- Uso industrial | Industrial use | Uso industrial

ALICATES VDE para Eletricistas



Alicate Bico Meia-Cana Reto VDE

Pliers Beak Half-Cane Straight VDE | Pinza Punta Media-Canã Reto VDE



Código	Tamanho	Peso (KG)	DIMENSÕES SIZE TAMANHO (MM)			Quant. Min.	
			A	B	C		
171019	6" (160 mm)	180g	75	220	18	60	5
171039	8" (200 mm)	242g	75	240	20	60	5*

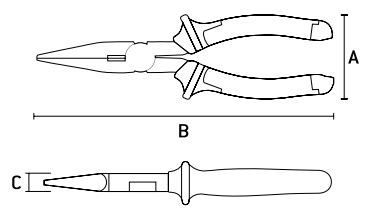

- Linha VDE | VDE Line | Línea VDE
- Acabamento polido | Polished finish | Acabado pulido
- Embalagem: Clipe Plástico | Packing: Plastic Clip | Embalaje: Clip Plástico

Alicate Corte Diagonal VDE

Diagonal Cutting Pliers VDE | Pinza Corte Diagonal VDE



Código	Tamanho	Peso (KG)	DIMENSÕES SIZE TAMANHO (MM)			Quant. Min.	
			A	B	C		
175069	6" (160 mm)	233g	132	265	23	60	5
175089	8" (200 mm)	298g	130	290	22	60	5

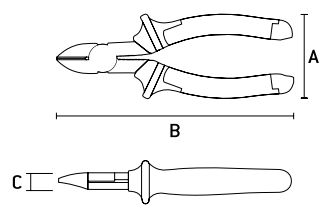
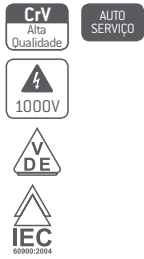

- Linha VDE | VDE Line | Línea VDE
- Acabamento polido | Polished finish | Acabado pulido
- Embalagem: Clipe Plástico | Packing: Plastic Clip | Embalaje: Clip Plástico

Alicate Universal VDE

Universal pliers Nickel | Alicates Universal Nickel



Código	Tamanho	Peso (KG)	DIMENSÕES SIZE TAMANHO (MM)			Quant. Min.	
			A	B	C		
169019	6" (160 mm)	242g	80	240	20	60	5*
169039	7" (180 mm)	295g	80	250	20	60	5*
169059	8" (200 mm)	522g	80	260	20	60	5

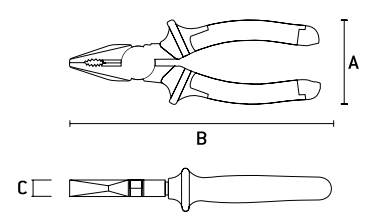

- Linha VDE | VDE Line | Línea VDE
- Acabamento polido | Polished finish | Acabado pulido
- Embalagem: Clipe Plástico | Packing: Plastic Clip | Embalaje: Clip Plástico

Alicate Bico Meia-Cana Reto Mini

Pliers Beak Half-Cane Straight Mini | Pinza Punta Media-Canã Reto Mini

				DIMENSÕES SIZE TAMANHO (MM)				
17820	1782055	5" (130 mm)	74g	A	B	C	120	6

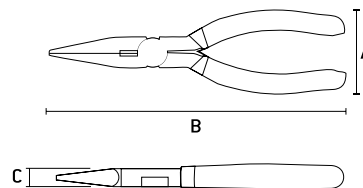

- Cabo emborrachado | Rubberized cable | Cable de goma
- Embalagem: Clipe Plástico | Packing: Plastic Clip | Embalaje: Clip Plástico

Alicate Bico Meia-Cana Curvo Mini

Pliers Beak Half-Cane Curved Mini | Pinza Punta Media-Canã Curvo Mini

				DIMENSÕES SIZE TAMANHO (MM)				
17822	1782255	5" (130 mm)	79g	A	B	C	120	6

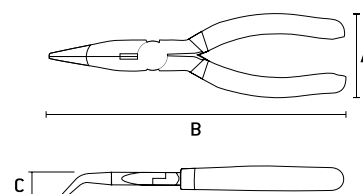

- Cabo emborrachado | Rubberized cable | Cable de goma
- Embalagem: Clipe Plástico | Packing: Plastic Clip | Embalaje: Clip Plástico

Alicate Corte Diagonal Mini

Diagonal Cutting Pliers Mini | Pinza Corte Diagonal Mini

				DIMENSÕES SIZE TAMANHO (MM)				
17824	1782455	5" (130 mm)	69g	A	B	C	120	6

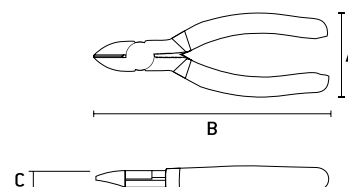

- Cabo emborrachado | Rubberized cable | Cable de goma
- Embalagem: Clipe Plástico | Packing: Plastic Clip | Embalaje: Clip Plástico

Alicate Universal Mini

Universal pliers Mini | Alicate Universal Mini

				DIMENSÕES SIZE TAMANHO (MM)				
17826	1782655	5" (130 mm)	79g	A	B	C	120	6

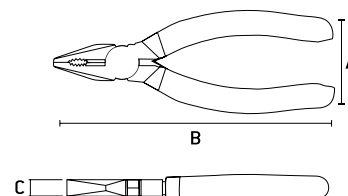

- Cabo emborrachado | Rubberized cable | Cable de goma
- Embalagem: Clipe Plástico | Packing: Plastic Clip | Embalaje: Clip Plástico

Mini Alicate Bico Meia-Cana Reto

Mini Pliers Beak Half-Cane Straight | Mini Pinza Punta Media-Canã Reto



			DIMENSÕES SIZE TAMAÑO (MM)				
178109	5" (130 mm)	104g	A	B	C	120	6

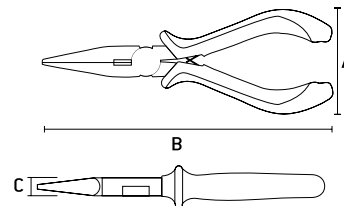

- Acabamento polido | Polished finish | Acabado pulido
- Cabo Plástico anatômico com dois componentes | Cable Anatomic plastic with two components | Cable plástico anatómico con dos componentes

Mini Alicate Bico Meia-Cana Curvo

Mini Pliers Beak Half-Cane Curved | Mini Pinza Punta Media-Canã Curvo



			DIMENSÕES SIZE TAMAÑO (MM)				
178129	5" (130 mm)	109g	A	B	C	60	6

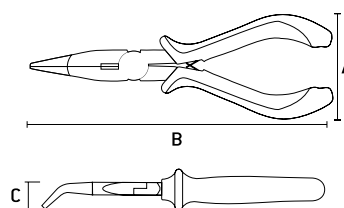

- Acabamento polido | Polished finish | Acabado pulido
- Cabo Plástico anatômico com dois componentes | Cable Anatomic plastic with two components | Cable plástico anatómico con dos componentes

Mini Alicate Corte Diagonal

Mini Diagonal Cutting Pliers | Mini Pinza Corte Diagonal



			DIMENSÕES SIZE TAMAÑO (MM)				
178149	5" (130 mm)	100g	A	B	C	120	6

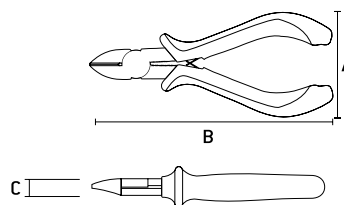

- Acabamento polido | Polished finish | Acabado pulido
- Cabo Plástico anatômico com dois componentes | Cable Anatomic plastic with two components | Cable plástico anatómico con dos componentes

Mini Alicate Universal

Mini Universal pliers | Mini Alicate Universal

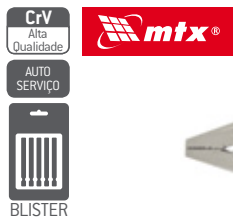

			DIMENSÕES SIZE TAMAÑO (MM)				
178169	5" (130 mm)	112g	A	B	C	120	6

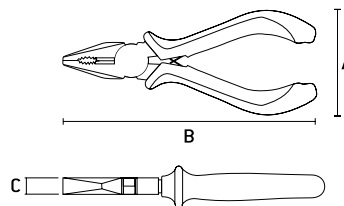

- Acabamento polido | Polished finish | Acabado pulido
- Cabo Plástico anatômico com dois componentes | Cable Anatomic plastic with two components | Cable plástico anatómico con dos componentes



1

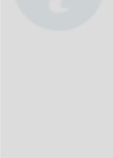
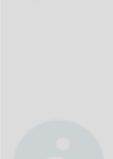

Alicate externo Bico Curvo

External pliers Beak Curved | Pinza externa Punta curva

				DIMENSÕES SIZE TAMAÑO (MM)				
183205	1832055	6" (150 mm)	138g	A	B	C	60	6

AUTO SERVIÇO

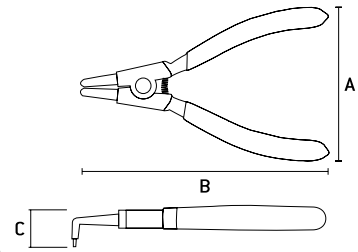

- Para anéis de retenção externos (furos) | For external retaining rings (holes) | Para anillos de retención externos (agujeros)
- Acabamento fosfatizado | Phosphatized Finish | Acabado fosfatizado
- Uso industrial | Industrial use | Uso industrial
- Embalagem: Clipe Plástico | Packing: Plastic Clip | Embalaje: Clip Plástico

Alicate interno Bico Curvo

Internal pliers Beak Curved | Pinza interna Punta curva

				DIMENSÕES SIZE TAMAÑO (MM)				
183255	1832555	6" (150 mm)	124g	A	B	C	60	6

AUTO SERVIÇO

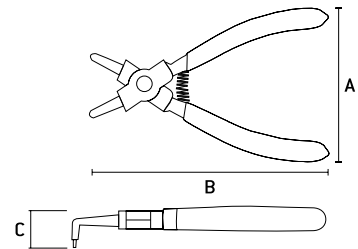

- Para anéis de retenção internos (furos) | For internal retaining rings (holes) | Para anillos de retención internos (agujeros)
- Acabamento fosfatizado | Phosphatized Finish | Acabado fosfatizado
- Uso industrial | Industrial use | Uso industrial
- Embalagem: Clipe Plástico | Packing: Plastic Clip | Embalaje: Clip Plástico

Alicate interno Bico Reto

Internal pliers Beak Reto | Pinza interna Punta Reto

				DIMENSÕES SIZE TAMAÑO (MM)				
183355	1833555	6" (150 mm)	127g	A	B	C	60	6

AUTO SERVIÇO

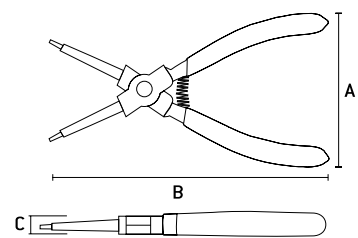

- Para anéis de retenção internos (furos) | For internal retaining rings (holes) | Para anillos de retención internos (agujeros)
- Acabamento fosfatizado | Phosphatized Finish | Acabado fosfatizado
- Uso industrial | Industrial use | Uso industrial
- Embalagem: Clipe Plástico | Packing: Plastic Clip | Embalaje: Clip Plástico

Alicate externo Bico Reto

External pliers Beak Reto | Pinza externa Punta Reto

				DIMENSÕES SIZE TAMAÑO (MM)				
183305	1833055	6" (150 mm)	143g	A	B	C	60	6

AUTO SERVIÇO

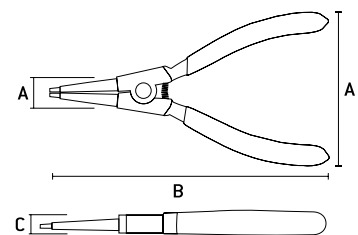

- Para anéis de retenção internos (furos) | For internal retaining rings (holes) | Para anillos de retención internos (agujeros)
- Acabamento fosfatizado | Phosphatized Finish | Acabado fosfatizado
- Uso industrial | Industrial use | Uso industrial
- Embalagem: Clipe Plástico | Packing: Plastic Clip | Embalaje: Clip Plástico

Torquês Armador

Concretor's Pincers | Tenaza para armar

AUTO SERVIÇO



Barcode	Size	Weight (KG)	DIMENSÕES SIZE TAMAÑO (MM)			Quant. Min.
			A	B	C	
1796455	10" (250 mm)	192g	65	242	60	6
1796555	12" (300 mm)	210g	65	300	60	6

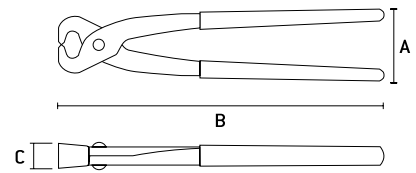

• Cabo emborrachado | Rubberized cable | Cable de goma

Torquês Azulejista

Tile Pincers | Tenaza para azulejo



Barcode	Barcode	Size	Weight (KG)	DIMENSÕES SIZE TAMAÑO (MM)			Quant. Min.	
				A	B	C		
179345	1793455	6" (150 mm)	231g	56	163	22	120	5
179385	1793855	8" (200 mm)	316g	60	210	23	60	6

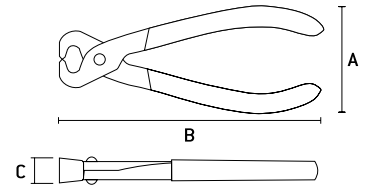

• Cabo emborrachado | Rubberized cable | Cable de goma

Alicate bomba d'água

Water Pump Pliers | Pinza Pico Loro



Barcode	Barcode	Size	Weight (KG)	DIMENSÕES SIZE TAMAÑO (MM)			Quant. Min.	
				A	B	C		
157185	1571855	10" (250 mm)	382g	60	240	10	60	5
157195	1571955	12" (300 mm)	597g	68	350	20	40	5

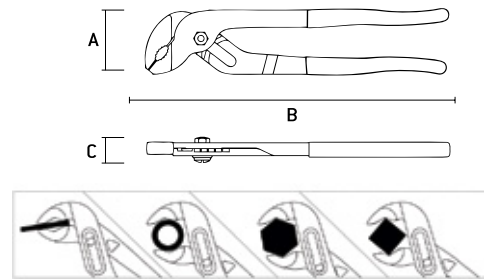

• Cabo emborrachado | Rubberized cable | Cable de goma

Alicate bomba d'água

Water Pump Pliers | Pinza Pico Loro

AUTO SERVIÇO



Barcode	Barcode	Size	Weight (KG)	DIMENSÕES SIZE TAMAÑO (MM)			Quant. Min.	
				A	B	C		
157089	1570895	10" (250 mm)	350g	65	350	24	60	6
157099	1570995	12" (300 mm)	694g	65	365	28	36	6

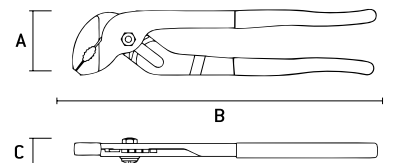

• Aço Carbono | Carbon steel | Acero carbono
 • Cabo dupla injeção com revestimento antiderrapante |
 Double injection cable with non-slip coating |
 Cable doble inyección con revestimiento antideslizante



Desencapador automático

Auto unplug | Desengrasador automático



antigo	177305	antigo	1773055	5" (130 mm)	227g	DIMENSÕES SIZE TAMAÑO (MM)			Quant. Min.
						A	B	C	6

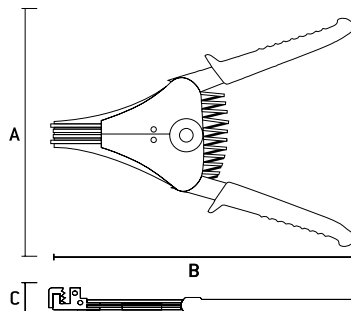

- Possibilita o desentape nas extremidades e no meio | Enables the release of the ends and the middle | Posibilita el desarrollo en las extremidades y en el medio
- Desentapa fios e cabos de 1.0mm a 3.2mm | Strips wires and cables from 1.0mm to 3.2mm | Desentapa cables y cables de 1.0mm a 3.2mm
- Fechamento controlado por mola | Spring-controlled closing | Cierre controlado por resorte

Desencapador de fios

Wire stripper | Desengrasador de cables



antigo	177505	antigo	1775055	5" (130 mm)	146g	DIMENSÕES SIZE TAMAÑO (MM)				Quant. Min.
						A	B	C	D	6

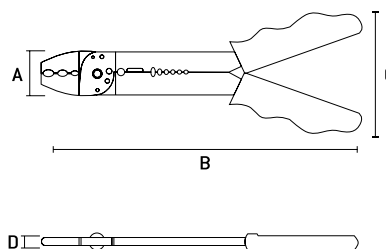

- Corta fios e cabos de bitolas 0.5mm a 6.5mm | Cut wire and wire sizes 0.5mm to 6.5mm | Corta hilos y cables de ancho de 0,5 mm a 6.5mm
- Desentapa fios e cabos de 1.5mm a 6.5mm | Strips wires and cables from 1.5mm to 6.5mm | Desentapa cables y cables de 1.5mm a 6.5mm

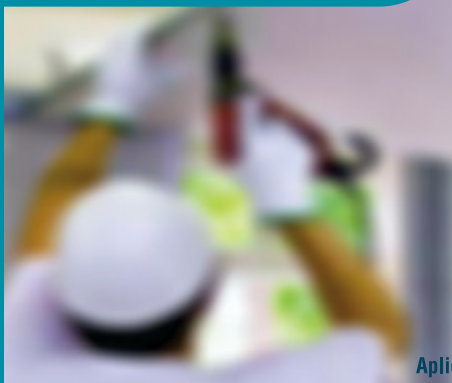

BITS COM LIMITADOR

BITS WITH LIMITATOR | BITS CON LIMITADOR

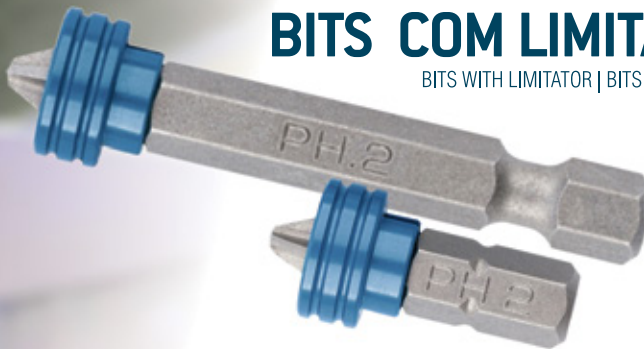

BLISTER

Encaixe Sextavado 1/4" | Hex socket 1/4" | Encaje Sexto 1/4" •
Imantado e com limitador | Magnetized and with limite | Magnetizado y con limitador •
Tamanho: 25mm|50mm | Size: 25mm|50mm | Tamaño: 25mm|50mm •
Aplicação para parede Gesso /Drywall | Wall application Plaster / Drywall | Aplicación para pared Yeso / Drywall •

DESENCAPADOR DE FIOS

AUTOMÁTICO COM PRENSA PARA TERMINAIS

Automatic wire stripper with press for terminals

Desencajador de hilos automático con prensa para terminales

antigo
17718

novo
1771855

KG
417g

DIMENSÕES | SIZE | TAMAÑO (mm)
A B
100 300

Quant. Min.
48

8

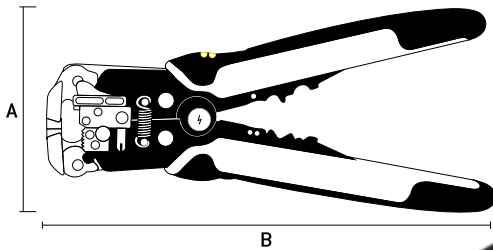

REGULADOR DE LIMITADOR

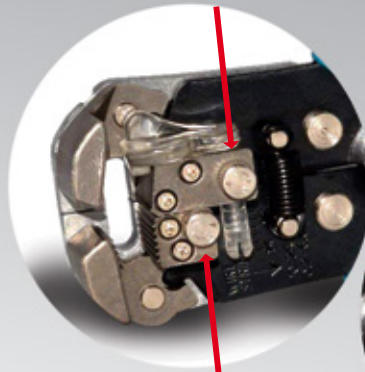

REGULADOR DE PRESSÃO



PRATICIDADE PARA EMENDAS



PRENSADOR DOS TERMINAIS

- Indicado para desencapar cabos e fios com bitolas de 0,2 a 6,0mm (10-24 AWG)
Suitable for stripping cables and wires with gauges from 0.2 to 6.0mm
Indicado para desencapar cables e hilos con anchuras de 0,2 a 6,0mm
- Com crimpador de terminais isolados e não isolados (10-22 AWG) de 0,50 a 6,0mm e cortador de fios.
With insulated and non-insulated (10-22 AWG) crimper from 0.50 to 6.0mm and wire cutter
Con cremallador de terminales aislados y no aislados (10-22 AWG) de 0,50 a 6,0 mm y cortador de hilos
- Cabo em aço carbono e lâminas de aço sintetizado de alta resistência.
Carbon steel cable and high strength synthetic steel blades. | Cable de acero al carbono y láminas de acero sintetizado de alta resistencia.
- Cabo em polipropileno reforçado com revestimento emborrachado
Rubberized reinforced polypropylene cable | Cable de polipropileno reforzado con revestimiento de goma
- Regulador de pressão para diferentes espessuras de fios | Pressure regulator for different wire thicknesses | Regulador de presión para diferentes espesores de t
- Limitador para ajuste de tamanho a ser desencapado | Limiter for size adjustment to be stripped | Limitador para ajuste de tamaño a ser desencapado
- Tamanho | Size | Tamaño: 8"

ALICATE CRIMPADOR

CATRACADO PARA CABOS RJ11, RJ12 e RJ45

Caught catching cranket for RJ11, RJ12 and RJ45 cables

Alicate crimpador catracado para cables RJ11, RJ12 y RJ45

antigo 17719	novo 1771955	KG 406g	DIMENSÕES SIZE TAMAÑO (mm)		Quant. Min.
			A 95	B 290	8

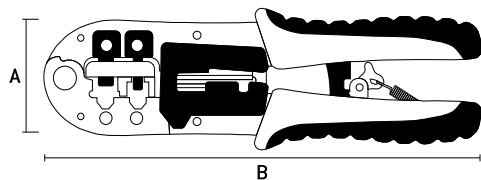

PARA CONECTORES
8 E 6 PINOS



CORTADOR
E DECAPADOR



CATRACA

- Indicado para Crimpar e Decapar cabos de rede e telefônicos.
Suitable for Crimping and Stripping Network and Telephone Cables. | Indicado para Crimpar y Decapar cables de red y telefônicos.
- Para cabos | For cables | Para cables: RJ11 - RJ12 - RJ45 / 6P e 8P.
- Cabo em aço e lâminas de corte em aço. | Steel cable and steel cutting blades. | Cable de acero y cuchillas de corte de acero.
- Cabo em polipropileno reforçado com revestimento emborrachado.
Reinforced polypropylene cable with rubberized coating. | Mango de polipropileno reforçado con revestimiento de goma.
- Tamanho | Size | Tamaño: 8"

Alicate de pressão mordente curvo

Curved cheek pressure pliers | Pinza de presión mordiente curvo

AUTO SERVIÇO



			DIMENSÕES SIZE TAMAÑO (MM)				
1843055	10" (250 mm)	465g	A	B	C	60	Quant. Min. 6

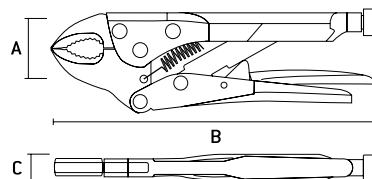

- Uso geral | General use | Uso general
- Niquelado | Nickel plated | níquel

Alicate de Pressão Mordente Reto

Pressure Munching Pliers | Alicate de Presión Mordiente Recto

AUTO SERVIÇO



			DIMENSÕES SIZE TAMAÑO (MM)				
1843155	10" (250 mm)	465g	A	B	C	60	Quant. Min. 6

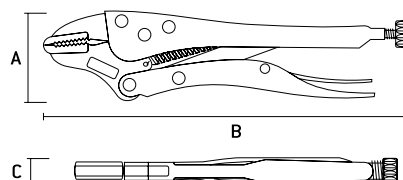

Alicate de Pressão Mordente Curvo Reto

Pressure Munching Pliers | Alicate de Presión Mordiente Recto

AUTO SERVIÇO



			DIMENSÕES SIZE TAMAÑO (MM)				
1843255	10" (250 mm)	465g	A	B	C	60	Quant. Min. 6

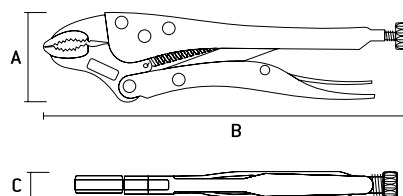

Alicate de Pressão Mordente Longo Reto

Pressure Munching Pliers | Alicate de Presión Mordiente Recto

AUTO SERVIÇO



			DIMENSÕES SIZE TAMAÑO (MM)				
1843355	9" (225 mm)	465g	A	B	C	60	Quant. Min. 6

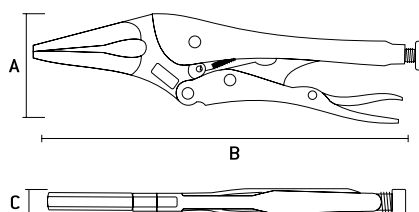

Alicate de Pressão Mordente Tipo C

Type U Munch Pressure Pliers | Alicate de presión Mordente Tipo C

AUTO SERVIÇO



			DIMENSÕES SIZE TAMAÑO (MM)				
1843455	11" (275 mm)	465g	A	B	C	60	6

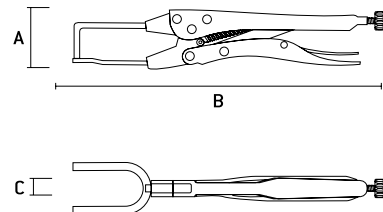
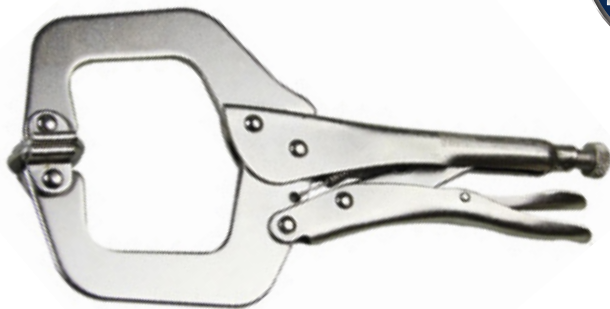

Alicate de Pressão Tipo Corrente

Current Type Pressure Pliers | Alicate de presión tipo corriente

AUTO SERVIÇO



			DIMENSÕES SIZE TAMAÑO (MM)				
1843555	18" (460 mm)	465g	A	B	C	60	6

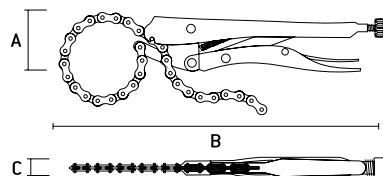

Alicate de Pressão Bico Chato

Flat Tip Pliers | Alicate de presión Boquilla Chato

AUTO SERVIÇO



			DIMENSÕES SIZE TAMAÑO (MM)				
1843655	8" (200 mm)	465g	A	B	C	60	6

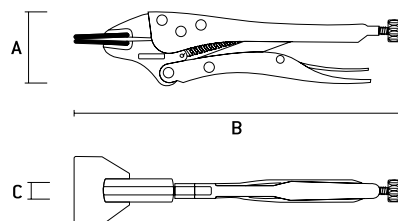

Talhadeira Plana

Flat Stone Chisel | Cíncel Plano



Barcode	Size	Weight	DIMENSÕES SIZE TAMAÑO (MM)			Pack	Quant. Min.
			A	B	C		
1870155	8" (200 mm)	1000g	30	200	12	60	6
1870255	10" (250 mm)	1100g	30	250	12	60	6
1870355	12" (300 mm)	1200g	30	300	12	60	6

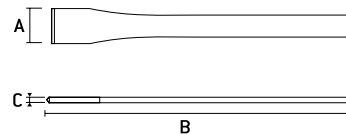

• Utilizada na construção civil | Used in construction | Utilizada en la construcción civil

Talhadeira Ponta Chata

Tip Flat Stone Chisel | Cíncel Punta Plana



Barcode	Size	Weight	DIMENSÕES SIZE TAMAÑO (MM)			Pack	Quant. Min.
			A	B	C		
1871155	8" (200 mm)	1000g	30	200	20	60	6
1871255	10" (250 mm)	1100g	30	250	25	60	6
1871355	12" (300 mm)	1200g	30	300	30	60	6

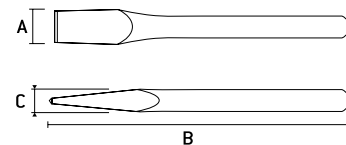

• Utilizada na construção civil | Used in construction | Utilizada en la construcción civil
 • Corpo Redondo | Round body | Cuerpo Redondo

Ponteiro Redondo

Round Pointer | Puntero Redondo



Barcode	Size	Weight	DIMENSÕES SIZE TAMAÑO (MM)			Pack	Quant. Min.
			A	B	C		
1880155	8" (200 mm)	1000g	20	200	5	60	6
1880255	10" (250 mm)	1100g	25	250	5	60	6
1880355	12" (300 mm)	1200g	30	300	5	60	6

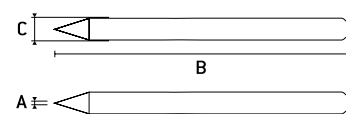

• Utilizada na construção civil | Used in construction | Utilizada en la construcción civil
 • Corpo Redondo | Round body | Cuerpo Redondo

Talhadeira Sextavada com protetor

Hexagonal Cleaver with protector | Taladradora Sexta con protector



Barcode	Size	Weight	DIMENSÕES SIZE TAMAÑO (MM)			Pack	Quant. Min.
			A	B	C		
1876055	300X25mm	531g	25	295	36	6	

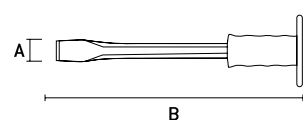

• Cabo com empunhadura plástica | Cable with plastic grip | Cable con empuñadura plástica
 • Utilizadas em mecânicas, indústrias e cortes de chapas metálicas | Used in mechanics, industries and cuts of sheet metal | Utilizadas en mecánicas, industrias y cortes de chapas metálicas

Ponteiro Sextavada com protetor

Hexagonal Pointer with Protector | Puntero Sextava con protector



Barcode	Size	Weight	DIMENSÕES SIZE TAMAÑO (MM)			Pack	Quant. Min.
			A	B	C		
1883455	300mm	528g	5	298	36	6	

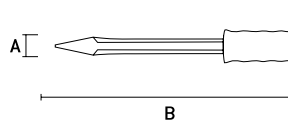

• Cabo com empunhadura plástica | Cable with plastic grip | Cable con empuñadura plástica
 • Utilizadas em mecânicas, indústrias e cortes de chapas metálicas | Used in mechanics, industries and cuts of sheet metal | Utilizadas en mecánicas, industrias y cortes de chapas metálicas



MINI TORNO/MORSA ARTICULADO COM VENTOSA

Mini articulated vice / vise with suction cup
Mini torno / morsa articulado con ventosa



185069



1500g

DIMENSÕES | SIZE | TAMAÑO (mm)

A

B



20



1

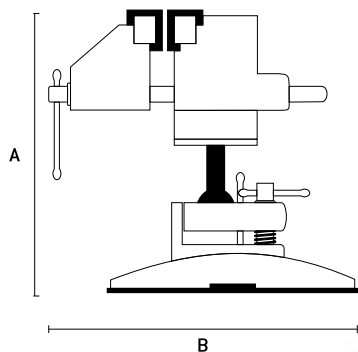

Mordentes emborrachados

- Rubber cheeks
- Mordazas emborrachadas



Base com ventosa para fixação

- Base with suction cup for attachment
- Base con ventosa para fijación

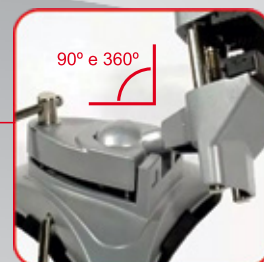

Articulação de 90° e 360°

- 90° and 360° Articulation
- Articulación de 90° e 360°

PARA SERVIÇOS LEVES E DELICADOS DE SOLDA, INSPEÇÃO, MONTAGEM, AJUSTES, POLIMENTO E ETC

For light and delicate welding services, inspection, assembly, adjustments, polishing and etc.

Para servicios ligeros y delicados de soldadura, inspección, montaje, ajustes, pulido y etc

- Possui base emborrachada que se prende a superfícies lisas e planas através de sucção de ar.
- Cabeça giratória a 360° e inclina até 90°
- Garras com pontas emborrachadas, mais segurança, firmeza e menor risco de estragar os objetos
- Manivelas de regulagem e travamento da base, das garras e da cabeça giratória
- Com esta ferramenta você pode trabalhar o mesmo objeto em diversos ângulos, sem a necessidade de ficar prendendo e desprendendo

- Has a rubber base that attaches to flat and smooth surfaces through air suction.
- Rotating 360° head and tilts up to 90°
- Rubber-tipped jaws, more safety, firmness and less risk of spoiling objects
- Adjusting and locking handles for base, claws and swivel head
- With this tool you can work the same object from several angles, without the need to be holding and releasing

- Posee una base de goma que se atiene a superfícies planas y planas a través de succión de aire.
- Cabeza giratoria a 360° e inclina hasta 90°
- Garras con puntas de goma, más seguridad, firmeza y menor riesgo de estropear los objetos
- Maniveles de regulación y bloqueo de la base, de las garras y de la cabeza giratoria
- Con esta herramienta usted puede trabajar el mismo objeto en diversos ángulos, sin la necesidad de quedar atrapando y desprendiendo

MINI TORNO/MORSA 70MM BASE ARTICULADA

Mini lathe / vise 70mm hinged base
Mini torno / morsa 70mm base articulada

		DIMENSÕES SIZE TAMAÑO (mm)			
185089	990g	A	B	20	1



90° e 360°



Mordentes emborrachados

- Rubber cheeks
- Mordazas emborrachadas

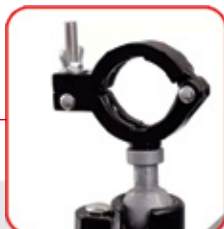

Suporte para Furadeira

- Drill Holder
- Soporte para Taladro



Articulação de 90° e 360°

- 90° and 360° Articulation
- Articulación de 90° e 360°



Encaixe da base emborrachado

- Rubber Base Fit
- Encaje de la base de goma

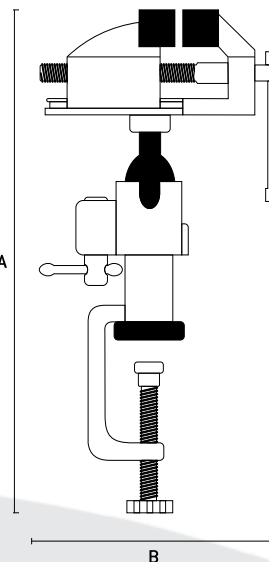

MULTIFUNCIONAL

| MULTIFUNCIONAL

Possui suporte de furadeira indicado para trabalhos leves, o suporte facilita muito na hora de fazer perfurações.

It has drill holder indicated for light work, the stand makes it much easier to drill holes.

Tiene soporte de taladro indicado para trabajos ligeros, el soporte facilita mucho a la hora de hacer perforaciones.

PARA FAZER ACABAMENTOS, CORTAR, LIMAR, LIXAR, ETC.

To make finishes, cut, lime, sand, etc.
Para hacer acabamentos, cortar, lima, lijar, etc.

TRABALHO PRÁTICO

| PRACTICAL WORK | TRABAJO PRACTICO

É ideal para realizar trabalhos que necessitam mobilidade para trabalhar perfeitamente em vários ângulos.

It is ideal for carrying out need mobility to work perfectly from various angles.

Es ideal para realizar trabajos que necesitan movilidad para trabajar perfectamente en varios ángulos.

Proporciona maior precisão na perfuração e menor possibilidade de quebra, principalmente das brocas finas.

Provides greater accuracy in drilling and less chance of breakage, mainly of fine drills.

Proporciona mayor precisión en la perforación y La menor posibilidad de rotura, principalmente de las brocas finas.



Tornos / Morsas de Bancada

Bench Vices | Prensatornillos



antigo	novo	C	DIMENSÕES SIZE TAMAÑO (MM)			Quant. Min.	
			A	B	C		
185055	1850555	1.1/2" (40 mm)	118	88	40	20	1
185075	1850755	2" (50 mm)	120	110	50	20	1
185095	1850955	2.1/2" (60 mm)	124	110	60	20	1
185115	1851155	3" (75 mm)	120	117	75	20	1

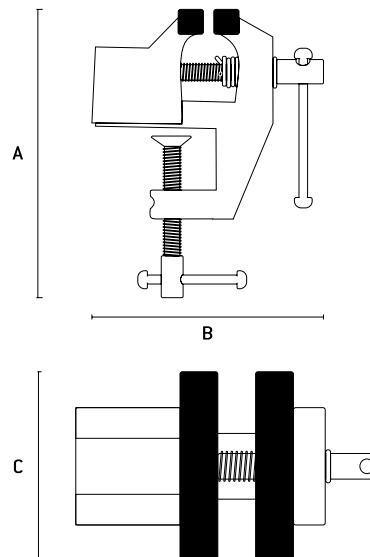

- Indicado para ferramentas, oficinas, serralherias e pra segurar peças e equipamentos em geral, na construção civil, e também na montagem e desmontagem de componentes | Indicated for tools, workshops, locksmiths and to insure parts and equipment in general, in civil construction, as well as assembly and disassembly of components | Indicado para herramientas, talleres, cerrajerías y para asegurar piezas y equipamientos en general, en la construcción civil, y también en el montaje y desmontaje de componentes

• Embalagem individual | Individual packing | Embalaje individual



Tornos / Morsas Base Giratória

Bench Vices | Prensatornillos



antigo	novo	C	DIMENSÕES SIZE TAMAÑO (MM)			Quant. Min.
			A	B	C	
186235	1862355	4" (100 mm)	133	265	100	1
186255	1862555	5" (125 mm)	140	270	125	1
186275	1862755	6" (150 mm)	170	345	150	1
186295	1862955	8" (200 mm)	221	408	200	1

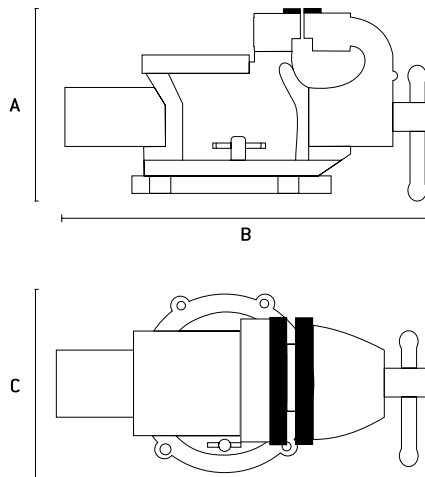

- Indicado para ferramentas, oficinas, serralherias e pra segurar peças e equipamentos em geral, na construção civil, e também na montagem e desmontagem de componentes | Indicated for tools, workshops, locksmiths and to insure parts and equipment in general, in civil construction, as well as assembly and disassembly of components | Indicado para herramientas, talleres, cerrajerías y para asegurar piezas y equipamientos en general, en la construcción civil, y también en el montaje y desmontaje de componentes

• Embalagem individual | Individual packing | Embalaje individual



FERRAMENTAS DE CARPINTEIRO

CARPENTER'S TOOLS
HERRAMIENTAS DE CARPINTERO

As ferramentas de carpinteiro GROSS, MTX e Sparta possuem ferramentas de extrema eficiência para o trabalho a ser desenvolvido. Utilizando matérias primas de qualidade as ferramentas tem um ótimo desempenho e proporcionam um excelente resultado. O profissional irá se surpreender com as ferramentas da marca GROSS e o usuário final com as ferramentas da MTX e Sparta..

The GROSS, MTX and Sparta carpenter tools have extreme efficiency tools for the job to be developed. Using quality raw materials the tools have a great performance and provide an excellent result. The professional will be amazed with the GROSS brand tools and the end user with MTX and Sparta tools.

Las herramientas de carpintero GROSS, MTX y Sparta poseen herramientas de extrema eficiencia para el trabajo a ser desarrollado. Utilizando materias primas de calidad las herramientas tienen un óptimo desempeño y proporcionan un excelente resultado. El profesional se sorprenderá con las herramientas de la marca GROSS y el usuario final con las herramientas de MTX y Sparta.

SIMBOLOGIA



CÓDIGO
CODE



CARACTERÍSTICAS
Technical Features



PESO DA PEÇA
Part Weight
Peso de la Pieza



CAIXA MASTER
Box Master | Caja Máster



QUANT. MINÍMA
Quant. Minimum
Cantidad Mínimo

Grampo Angular

Angular Cleat | Grapa Angular



antigo	novo	KG	DIMENSÕES SIZE TAMAÑO (MM)			Quant. Min.	
			A	B	C		
203205	20320555	149g	75	210	110	100	10

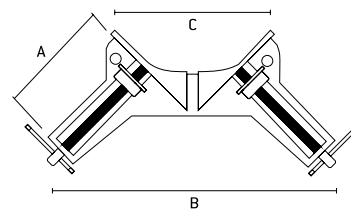

- Produzido em alumínio | Produced in aluminum | Producido en aluminios
- Ideal para esquadrear peças angulares | Ideal for squaring angled pieces | Ideal para encuadrar piezas angulares

Grampo Sargento Tipo F

Staple Sergeant Type F | Grapa Sargento Tipo F



		KG	DIMENSÕES SIZE TAMAÑO (MM)			Quant. Min.	
			A	B	C		
204029	6" (150 mm)	358	80	210	150	50	25
204039	8" (200 mm)	385	80	260	200	50	25
204059	12" (300 mm)	438	80	365	300	50	25

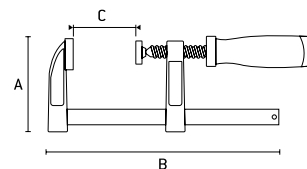

Mordentes com protetores plásticos
- Mordants with plastic protectors
- Mordazas con los protectores plásticos

- Corpo em aço carbono | Carbon steel body | Cuerpo en acero al carbono
- Cabo emborrachado | Rubberized cable | Mango de goma

Grampo Sargento Aperto Rápido

Staple Sergeant Quick Tight | Grapa Sargento Apriete Rápido



		KG	DIMENSÕES SIZE TAMAÑO (MM)			Quant. Min.	
			A	B	C		
205619	6" (150 mm)	184	150	280	150	96	12
205629	8" (200 mm)	196	155	335	200	96	12

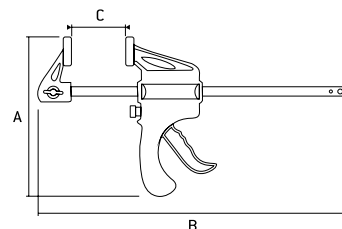

Mordentes com protetores plásticos
- Mordants with plastic protectors
- Mordazas con los protectores plásticos

- Aperto rápido | Quick Tight | Apriete rápido
- Ideal para fixar peças em processos de colagem, montagem de móveis entre outros | Ideal for securing parts in bonding processes, assembling furniture among others | Ideal para fijar piezas en procesos de pegado, montaje de muebles entre otros
- Grampo em plástico rígido ABS de alta resistência | High tensile ABS plastic clamp | Clip de plástico rígido ABS de alta resistencia
- Não usar para sustentação de peças | Do not use for parts | No utilizar para la ayuda de piezas

Grampo Multiuso para Marceneiro

Multipurpose Clip for Handyman | Grapa Multiuso para carpintero



		KG	DIMENSÕES SIZE TAMAÑO (MM)			Quant. Min.	
			A	B	C		
2078255	3" (75mm)		40	83	33	120	12
2078455	4" (100mm)		50	115	42	120	12
2078655	6" (150mm)		84	160	70	60	6
2078855	9" (225mm)		99	205	82	60	6

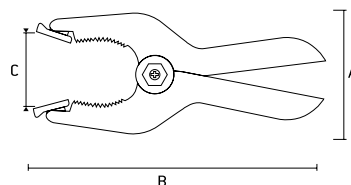

Grampo em Forma de C

C-shaped clip | Grapa en forma de C



	DIMENSÕES SIZE TAMAÑO (MM)	DIMENSÕES SIZE TAMAÑO (MM)			Quant. Min.	
		A	B	C		
206039	3" (75 mm)	90	170	75	24	12
206049	4" (100 mm)	110	215	100	24	12
206059	5" (125 mm)	125	250	125	24	6
206069	6" (150 mm)	130	280	150	24	6

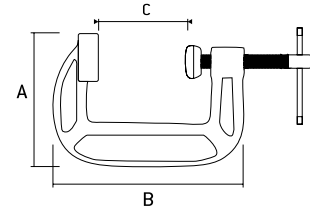

- Corpo de ferro reforçado | Reinforced iron body | Cuerpo de hierro reforzado
- Protetor dos mordentes de plástico | Plastic Cheek Protector | Protector de las mordazas de plástico

Grampo em Forma de C Ajustável

C-shaped clip Adjustable | Grapa en forma de C ajustable



	DIMENSÕES SIZE TAMAÑO (MM)	DIMENSÕES SIZE TAMAÑO (MM)			Quant. Min.	
		A	B	C		
206109	2" - 3" (50 - 75 mm)	80	130	75	48	12
206129	3" - 6" (75 - 150 mm)	95	170	150	24	6
206149	4" - 7" (100 - 175 mm)	110	195	175	12	1



Ajuste de Tamanho
- Size Adjustment
- Ajuste de tamaño

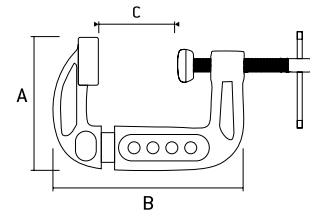

- Corpo de ferro reforçado | Reinforced iron body | Cuerpo de hierro reforzado
- Fosfatizado | Phosphatized | Fosfatizado

Grampo em Forma de C Pintado

C-shaped clip Painted | Grapa en forma de C pintado



	antigo	novo	DIMENSÕES SIZE TAMAÑO (MM)	DIMENSÕES SIZE TAMAÑO (MM)			Quant. Min.	
				A	B	C		
206505	2065055	2"	(50 mm)	73	110	50	120	6
206535	2065355	3"	(75 mm)	77	148	75	60	6
206565	2065655	4"	(100 mm)	87	170	100	60	6
206625	2066255	6"	(150 mm)	110	250	150	30	1
206655	2066555	8"	(200 mm)	140	315	200	16	1

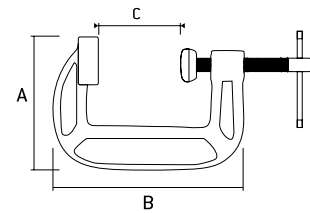

- Corpo de ferro reforçado | Reinforced iron body | Cuerpo de hierro reforzado

Conjunto de Grampos em Forma de C

Set of C-shaped Clips | Conjunto de grapas en forma de C



	antigo	novo	DIMENSÕES SIZE TAMAÑO (MM)	DIMENSÕES SIZE TAMAÑO (MM)			Quant. Min.	
				A	B	C		
206755		2067555	1"	45	55	25	50	1
			2"	55	85	50		
			3"	65	120	75		

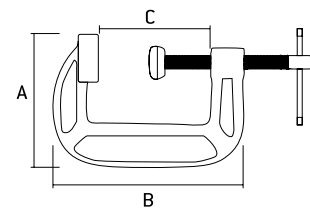

- Corpo de ferro reforçado | Reinforced iron body | Cuerpo de hierro reforzado
- Pintado | Painted | Pintado

Plainas Hobbie

Hobbie Planers | Llanas Hobbie



antigo	novo	S	DIMENSÕES SIZE TAMAÑO (MM)			Quant. Min.	
			A	B	C		
210205	2102055	nº 1	50	150	65	48	1
210225	2102255	nº 2	53	190	75	36	1

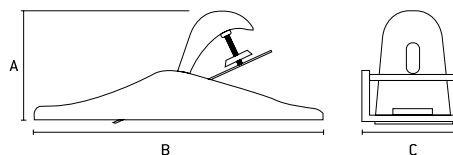

- Lamina temperada de aço Rápido | Tempered steel sheet Fast | Lamina templada de acero rápido
- Corpo de aço fundido | Casting steel body | Cuerpo de acero fundiendo
- Resistente a deformações | Resistant to deformation | Resistente a las deformaciones
- Para remover excesso de madeira nos lugares pequenos e difíceis de alcançar |

To remove excess wood in places that are small and hard to reach | Para quitar exceso de madera en los lugares pequeños y difíciles de alcanzar

Plaina Profissional

Professional Plane | Cepilladora profesional

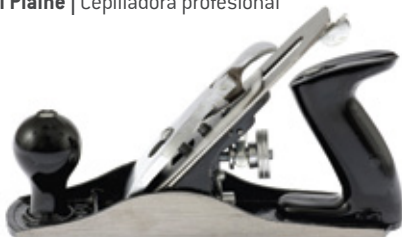

antigo	novo	S	DIMENSÕES SIZE TAMAÑO (MM)			Quant. Min.	
			A	B	C		
210785	2107855	nº 3	135	240	60	15	1
210795	2107955	nº 4	144	262	65	12	1

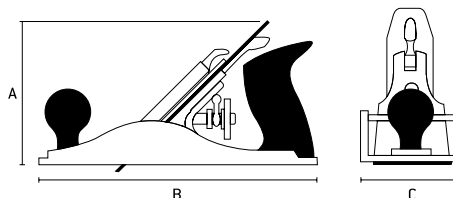

- Corpo de aço fundido | Casting steel body | Cuerpo de acero fundiendo
- Resistente a deformações | Resistant to deformation | Resistente a las deformaciones
- Base lisa | Smooth base | Base lisa
- Cabo Plástico | Plastic Cable | Cable de plástico

Machado cabo de fibra

Ax fiber cable | Machado cable de fibra



antigo	novo	S	DIMENSÕES SIZE TAMAÑO (MM)			Quant. Min.	
			A	B	C		
21637	2163755	600g	146	373	22	24	6
	2163955	800g	167	409	27	12	6

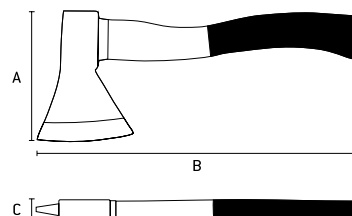

- Cabo Anatômico | Anatomical Cable | Mango Anatómico
- Aço forjado e temperado | Forged and tempered steel | Acero forjado y templado
- Ângulo de afiação 20 - 30% | Sharpening Angle 20 - 30% | Ángulo de afinación 20 - 30%



Caixa Plástica meia esquadria

Plastic housing half miter | Caja Plástica media esquadra



			DIMENSÕES SIZE TAMAÑO (MM)				
225305	2253055	335g	A	B	C	36	1

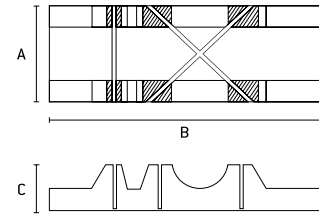

- Acompanha Serra (300mm) | Follow Saw (300mm) | Acompañante Sierra (300mm)
- Cortes em ângulos de 45° e 90° | Cuts at angles of 45° and 90° | Cortes en ángulos de 45° y 90°

Caixa Plástica para serra meia esquadria

Plastic box for half miter saws | Caja Plástica para sierra media esquadra

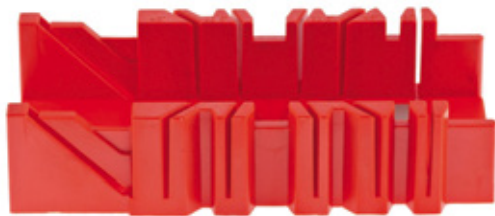

		DIMENSÕES SIZE TAMAÑO (MM)				
225479	363g	A	B	C	24	6

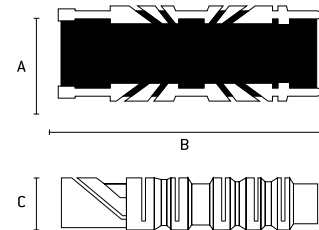

- Cortes em ângulos de 22,5°, 45° e 90° | Cuts at angles of 45° and 90° | Cortes en ángulos de 45° y 90°

Serra meia esquadria manual de precisão

Precision half-miter saw | Sierra media esquadra manual de precisión



		DIMENSÕES SIZE TAMAÑO (MM)			
227329	2.250g	A	B	4	1

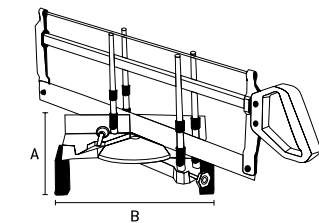

- Permite cortes precisos em planos horizontais e verticais | Allows precise cuts in horizontal and vertical planes | Permite cortes precisos en planos horizontales y verticales

Serra meia esquadria manual de precisão

Precision half-miter saw | Sierra media esquadra manual de precisión



		DIMENSÕES SIZE TAMAÑO (MM)			
227409	4.150g	A	B	4	1

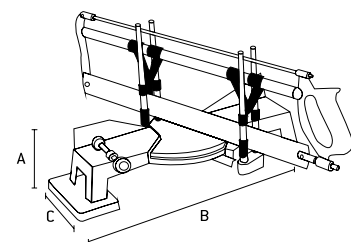

- Permite cortes precisos em planos horizontais e verticais | Allows precise cuts in horizontal and vertical planes | Permite cortes precisos en planos horizontales y verticales
- Com inclinação da lâmina | With blade tilt | Con inclinación de la hoja

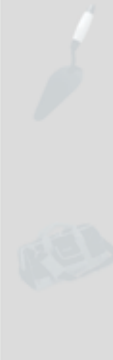
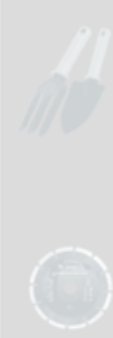

Serrote de costa para madeira 12 TPI - 14"

Wood sawing saw 12 TPI | Serrucho de costa para madeira 12 TPI



231489	14" (350mm)	398g	24	6

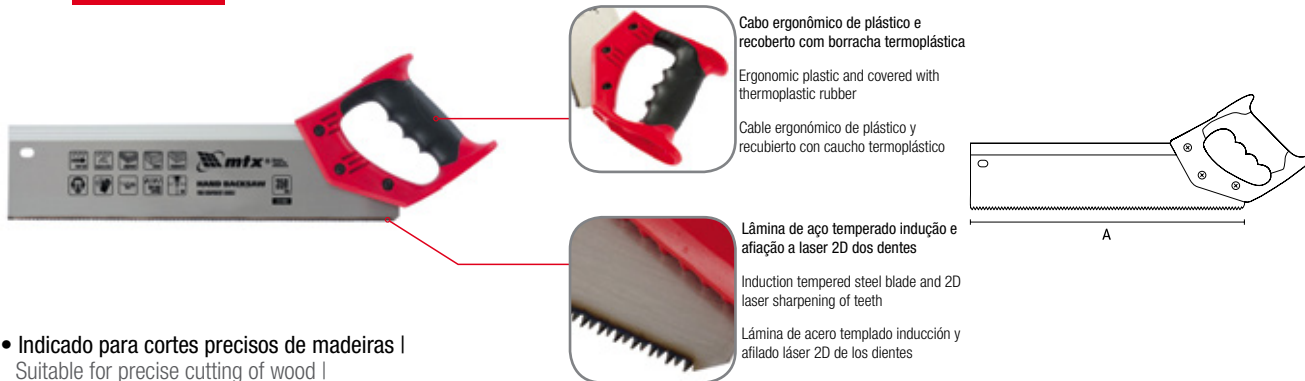

- Indicado para cortes precisos de madeiras | Suitable for precise cutting of wood | Indicado para cortes precisos de madeiras
- Para ser usado com a caixa meia esquadria (não acompanha) | To be used with half miter box (not attached) | Para ser utilizado con la caja media escuadra (no acompañada)

Serrote para gesso/Drywall

Plaster saw/drywall | Serrucho para yeso / Drywall



233929	7" (180 mm)	198g	36	12

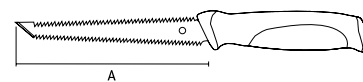

- Lâmina de aço temperado | Hardened steel blade | Lámina de acero templado
- 9 dentes por polegada | 9 teeth per inch | 9 dientes por pulgada
- Dupla afiação | Double edging | Doble afilado
- Ponta afiada para furo inicial | Sharp tip for initial hole | Punta afilada para el agujero inicial
- Linha dupla de corte | Double cutting line | Línea doble de corte

Serrote para madeira

Miter Saw Blade | Lámina para serra media esquadra



235499	16" (400 mm)	400	24	6
235509	18" (450 mm)	450	24	6
235519	20" (500 mm)	500	24	6
235799	22" (550mm) black series	550	24	6



• 235499 | 235509 | 235519



235799
• black series

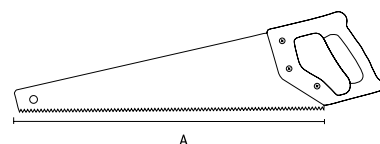

- Lâmina de aço com revestimento teflon | Teflon coated steel blade | Lámina de acero con revestimiento teflón
- 7-8 dentes por polegada com afiação a laser 3D | 7-8 teeth per inch with 3D laser sharpening | 7-8 dientes por pulgada con afilado láser 3D
- Cabo ergonômico de plástico e recoberto com borracha termoplástica | Ergonomic plastic cable and covered with thermoplastic rubber | Cable ergonómico de plástico y recubierto con caucho termoplástico



Tripla afiação a laser 3D Corte fácil e rápido nos 2 sentidos

Triple 3D laser sharpening Quick and easy cutting in 2 directions

Triple afilado láser 3D Corte fácil y rápido en los 2 sentidos

Serrote com cabo de madeira

Hacksaw with wooden handle | Sierra con cable de madera



antigo	novo	DIMENSÕES SIZE TAMANHO (MM)	Quant. Min.		
			A	Quant. Min.	Quant. Min.
231855	2318555	16" (400 mm)	400	48	12
231875	2318755	18" (450 mm)	450	48	12
	2318955	20" (500 mm)	500	48	6

AUTO SERVIÇO

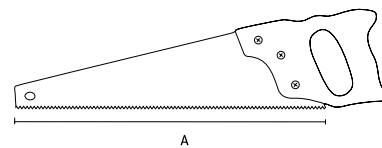

- Lâmina de aço | Steel blade | Lámina de acero
- Lâmina com régua | Blade with ruler | Lámina con regla
- 6 dentes por polegada temperados | 6 teeth per inch tempered | 6 dientes por pulgada templados

Serrote para gesso/drywall cabo de madeira

Plaster saw/drywall wooden cable | Serrucho para yeso / Drywall mango de madera



antigo	novo	DIMENSÕES SIZE TAMANHO (MM)	Quant. Min.		
			A	Quant. Min.	Quant. Min.
233905	2339055	7" (180 mm)	320	200	1*

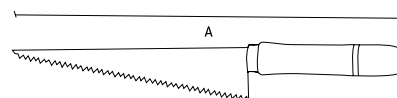

- Indicado para cortar gesso e drywall em geral | Suitable for cutting plaster and drywall in general | Indicado para cortar yeso y drywall en general
- Lâmina de aço carbono | Carbon Steel Blade | Lámina de acero al carbono

Formão cabo plástico

Plastic cable chisel | Cíncel mango de plástico



antigo	novo	DIMENSÕES SIZE TAMANHO (MM)	Quant. Min.				
			A	B	Quant. Min.		
244055	2440555	1/4"	6	215	93g	120	1
	2440755	3/8"	10	233	100g	120	1
2441055	2441055	1/2"	12	233	120g	120	1
	244175	5/8"	16	250	135g	120	1
2442055	2442055	23/32"	18	245	137g	60	1
	2442555	1"	24	250	148g	60	1
2443555	2443555	1.1/4"	32	257	182g	60	1
	2444055	1.1/2"	38	258	267g	60	1

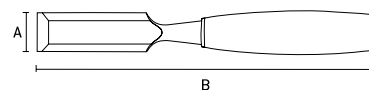

- Lâmina de aço carbono temperado | Tempered carbon steel blade | Lámina de acero al carbono templado
- Cabo plástico resistente | Heavy Duty Plastic Cable | Mango plástico resistente

Formões cabo plástico com borracha

Plastic Rubber Cable Chisel | Formones mango de plástico con caucho



CrV
Alta
Qualidade

HRc
60

AUTO SERVIÇO



DIMENSÕES SIZE TAMANHO (MM)	Quant. Min.					
	A	B	Quant. Min.			
245019	1/4"	6	330	230g	50	1
245059	3/8"	10	330	244g	50	1
245079	1/2"	12	330	260g	50	1
245119	5/8"	16	330	260g	50	1
245139	23/32"	18	330	280g	50	1
245169	7/8"	22	330	300g	50	1
245189	1.1/32"	26	330	310g	50	1
245219	1.1/4"	32	330	340g	50	1
245259	1.1/2"	38	330	360g	50	1

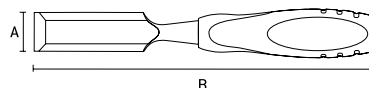

- Lâmina de aço CrV de alta resistência para absorção de impactos | High strength CrV steel blade for impact absorption | Lámina de acero CrV de alta resistencia para absorción de impactos
- Cabo anatômico de plástico com borracha termoplástica | Anatomical plastic cable with thermoplastic rubber | Mango anatômico de plástico con caucho termoplástico

Jogo de Formões

Chisels set | Juego de Formones

CrV
Alta
Qualidade

HRC
60

BLISTER



244329	1/4" 1/2" 23/32" 15/16"	DIMENSÕES SIZE TAMAÑO (MM)		16	4
		A	B		
		6	320		
		12	320		
		18	320		
		24	320		

4
peças
parts | piezas

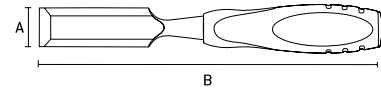

- Lâmina de aço especial de alta resistência para absorção de impactos | High strength special steel blade for impact absorption | Lámina de acero especial de alta resistencia para absorción de impactos
- Cabo anatômico de plástico com borracha termoplástica | Anatomical plastic cable with thermoplastic rubber | Cable anatómico de plástico con caucho termoplástico

Jogo de formões para entalhador

Chisels set | Juego de cinceles



antigo	novos	KG	DIMENSÕES SIZE TAMAÑO (MM)			72	12
246165	2461655	140g	A	B	C		
			189	270	20		



13
peças
parts | piezas

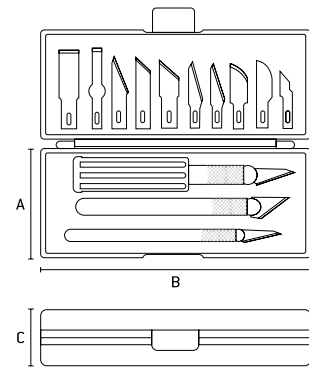

- Lâmina de aço | Steel Blade | Lámina de acero
- Cabo plástico | Plastic cable | Cable de plástico
- Embalagem: Caixa Plástica | Packing: Plastic Box | Embalaje: Caja Plástica

Pé de cabra

Wrecking Bar | Barreta Sacaclavos



antigo	novos	KG	DIMENSÕES SIZE TAMAÑO (MM)		12	1
252265	2522655	1kg	A	B		
			31	600		
252285	2522855	1.398g	14	900	12	1*

HRC
42

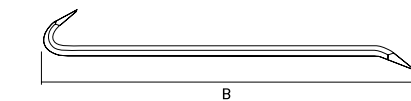

- Corpo sextavado | Hexagonal body | Cuerpo hexagonal
- Aço forjado | Forged steel | Acero forjado
- Para retirar pregos, desmontar caixarias, casas de madeiras | To remove nails, disassemble boxes, wooden houses | Para retirar clavos, desmontar cajeros, casas de madera

Pé de cabra

Wrecking Bar | Barreta Sacaclavos



252339	24" (600 mm)	1960g	DIMENSÕES SIZE TAMAÑO (MM)		6	1
			A	B		
			45	600		

HRC
44



- Corpo sextavado pintado | Painted hexagonal body | Cuerpo hexagonal pintado
- Aço forjado | Forged steel | Acero forjado
- Para retirar pregos, desmontar caixarias, casas de madeiras | To remove nails, disassemble boxes, wooden houses | Para retirar clavos, desmontar cajeros, casas de madera



MEDICÇÃO

MEASUREMENT | MEDICIÓN

FERRAMENTAS DE MEDICÇÃO

MEASURING'S TOOLS
HERRAMIENTAS DE MEDICIÓN

As ferramentas de medição GROSS, MTX e Sparta proporcionam precisão ao trabalho a ser desenvolvido. Utilizando matérias primas de qualidade as ferramentas tem um ótimo desempenho e proporcionam um excelente resultado tanto para profissionais quanto para amadores.

The GROSS, MTX and Sparta measuring tools give precision to the work to be done. Using quality raw materials the tools have a great performance and provide an excellent result for both professionals and amateurs.

Las herramientas de medición GROSS, MTX y Sparta proporcionan precisión al trabajo a desarrollar. Utilizando materias primas de calidad las herramientas tiene un óptimo rendimiento y proporciona un excelente resultado tanto para profesionales como para aficionados.

SIMBOLOGIA



CÓDIGO
CODE



CARACTERÍSTICAS
Technical Features



PESO DA PEÇA
Part Weight
Peso de la Pieza



CAIXA MASTER
Box Master | Caja Máster



QUANT. MINÍMA
Quant. Minimum
Cantidad Mínima



Trena

Trains | Cinta Métrica

AUTO SERVIÇO



antigo	novo	KG	DIMENSÕES SIZE TAMAÑO (MM)			Quant. Min.		
			A	B	C			
31311	3131155	3m x 16mm	134g	65	65	16	120	12
31312	3131255	5m x 18mm	203g	70	70	18	120	12
31314	3131455	10m x 25mm	438g	95	95	25	72	6
	3130255	3m x 19mm	100g	65	65	19	120	12
	3130355	5m x 25mm	242g	75	75	25	120	12
	3130455	7,5m x 25mm	300g	80	80	25	60	6
	3130555	10m x 25mm	395g	95	95	25	60	6



3130255
3130355
3130455
3130555

- estojo plástico | plastic case | caja de plástico
- graduação mm/pol. | graduation mm / in. | graduación mm / pulg.

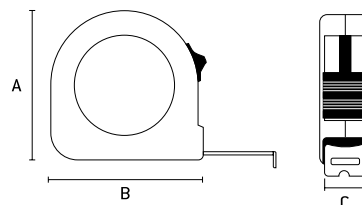

3131155
3131255
3131455

- estojo emborrachado | rubbery | recubierto de goma
- graduação mm | graduation mm | graduación mm

- Fita de aço | Steel strip | Cinta de acero
- Botão de trava da fita | Ribbon lock button | Botón de bloqueo de cinta
- Clipe metálico para cinto | Metal clip for belt | Clip metálico para cinturón
- Alça de nylon para transporte | Nylon carrying handle | Alza de nylon para transporte
- Gancho auto ajustável da fita | Auto Adjustable Ribbon Hook | Gancho auto ajustable de la cinta
- Embalagem: encartelado | Packing: Incarcerated | Embalaje: embalado

Trena

Trains | Cinta Métrica

AUTO SERVIÇO



antigo	novo	KG	DIMENSÕES SIZE TAMAÑO (MM)			Quant. Min.		
			A	B	C			
310169	310169	3m x 13mm	117g	65	65	13	120	12
310179	310179	5m x 19mm	200g	70	70	19	120	12
310189	310189	7,5m x 25mm	340g	80	80	25	72	6
3100455	3100455	3m x 19mm	108g	65	65	19	120	12
3100555	3100555	5m x 25mm	250g	70	70	25	120	12
3100655	3100655	7,5m x 25mm	317g	80	80	25	60	6
3100055	3100055	10m x 25mm	417g	95	95	25	60	6



310169
310179
310189

- estojo plástico | plastic case | caja de plástico
- graduação mm | graduation mm | graduación mm

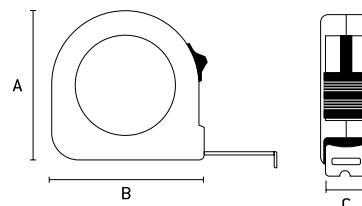

3100455
3100555
3100655
3100055

- estojo emborrachado | rubbery | recubierto de goma
- imantado | magnetized | magnetizado
- graduação mm/pol. | graduation mm / in. | graduación mm / pulg.

- Fita de aço | Steel strip | Cinta de acero
- Estojo Anatômico | Anatomical Case | Estuche Anatómico
- 3 Botões de trava da fita | 3 Ribbon lock buttons | 3 Botones de bloqueo de cinta
- Clipe metálico para cinto | Metal clip for belt | Clip metálico para cinturón
- Alça de nylon para transporte | Nylon carrying handle | Alza de nylon para transporte
- Gancho auto ajustável da fita | Auto Adjustable Ribbon Hook | Gancho auto ajustable de la cinta
- Embalagem: encartelado | Packing: Incarcerated | Embalaje: embalado

Trena

Trains | Cinta Métrica

AUTO SERVIÇO



Código	Dimensões	Peso	DIMENSÕES SIZE TAMAÑO (MM)			Quant. Min.	
			A	B	C		
31122	3m x 16mm	160g	65	65	16	144	12*
31124	5m x 25mm	323g	70	70	25	96	2*
31126	10m x 25mm	593g	95	95	25	48	6*

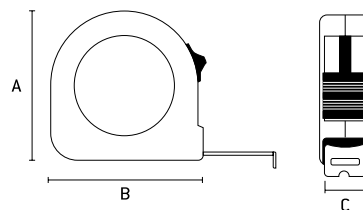

- Emborrachado | rubbery | recubierto de goma
- Fixador e marcador de dois lados | two-sided marker and fastener | fijador y marcador de dos lados
- Fita de aço com cobertura de nylon e marcação em milímetros | Steel tape with nylon cover and marking in millimeters | Cinta de acero con cubierta de nylon y marcado en milímetros
- Botão de trava da fita | Ribbon lock button | Botón de bloqueo de cinta
- Clipe metálico para cinto | Metal clip for belt | Clip metálico para cinturón
- Alça de nylon para transporte | Nylon carrying handle | Alza de nylon para transporte
- Gancho auto ajustável da fita | Auto Adjustable Ribbon Hook | Gancho auto ajustable de la cinta
- Embalagem: Blister | Packing: Blieter | Embalaje: Blister

Trena Longa

Long Trains | Cinta Métrica Larga



Código	Código	Dimensões	Peso	DIMENSÕES SIZE TAMAÑO (MM)			Quant. Min.	
				A	B	C		
314305	3143055	20m x 12,5mm	375g	145	240	22	40	1
314355	3143555	30m x 12,5mm	468g	145	255	22	40	1
314405	3144055	50m x 12,5mm	700g	170	260	22	20	1

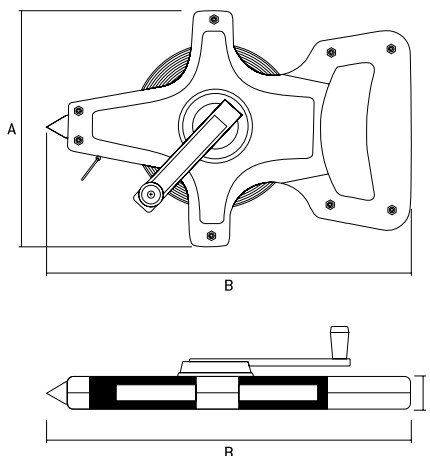

- Corpo de plástico resistente | Sturdy plastic body | Cuerpo de plástico resistente
- Ponta para fixar no terreno | Fixing point on the ground | Punta para fijar sobre el terreno
- Fita de PVC milimetrada | Millimeter PVC tape | Cinta de PVC milimétrica
- Largura da Fita de 12,5mm | 12,5mm Width Thickness | Ancho de la cinta de 12,5mm
- Resistente a umidade e variações de temperatura | Resistant to moisture and temperature variations | Resistente a la humedad y variaciones de temperatura
- Manivela para recolhimento da fita | Crank for tape pickup | Manivela para la recogida de la cinta
- Clipe metálico na ponta da fita | Metal clip on the end of the ribbon | Clip metálico en la punta de la cinta
- Embalagem: caixa | Packing: Box | Embalaje: caja

Paquímetro Digital

Digital Caliper | Calibrador Digital



316119	150mm	322g	DIMENSÕES SIZE TAMAÑO (MM)			50	10
			A	B	C		
			90	245	25		

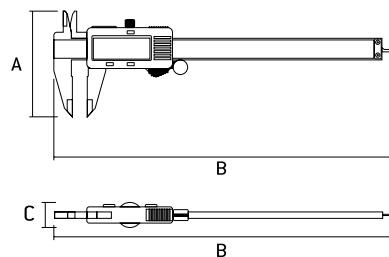

- Faixa de medição: (de 0" a 6") 0 a 150mm | Measuring range: (from 0 "to 6") 0 to 150mm | Rango de medición: (de 0 a 6) 0 a 150 mm
- Divisão de escala: $\pm 0,01\text{mm}$ / $0,0005 - 1/64"$ | Accuracy: $0,01\text{mm}$ / $0,0005 - 1/64"$ | Precisión: $0,01\text{mm}$ / $0,0005 - 1/64"$
- Bateria 2x 1,5V - SR44 | 2x 1.5V Battery - SR44 | Bateria 2x 1,5V - SR44
- Medição fácil e com precisão | Easy and accurate measurement | Medición fácil y con precisión
- Indicado para medições internas e externas | Indicated for internal and external measurements | Indicado para mediciones internas y externas
- Embalagem: caixa plástica | Packing: plastic box | Embalaje: caja plástica

Paquímetro Digital

Universal Caliper | Calibrador Universal



3163159	6"/150mm	306g	DIMENSÕES SIZE TAMAÑO (MM)			50	10
			A	B	C		
3163259	8"/200mm	431g	105	310	20	50	10

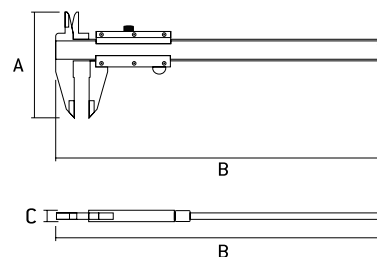

- Divisão de escala $\pm 0,02\text{ mm}$ | Scale division $\pm 0,02\text{ mm}$ | División de escala $\pm 0,02\text{ mm}$
- Faixa de medição: milímetros | Measuring range: millimeters | Rango de medición: milímetros
- Quadrimensão | Four dimensions | Cuatro dimensiones
- Cursor Monobloco | Monobloc Cursor | Cursor Monobloco
- Embalagem: caixa plástica | Packing: plastic box | Embalaje: caja plástica

Micrômetro

Micrometer | Micrómetro



3172559	0 - 25 mm	303g	DIMENSÕES SIZE TAMAÑO (MM)			50	5
			A	B	C		
3175059	25 - 50 mm	382g	95	185	30	50	5
3177559	50 - 75 mm	580g	108	210	30	25	5
3170059	75 - 100mm	725g	130	240	30	20	5

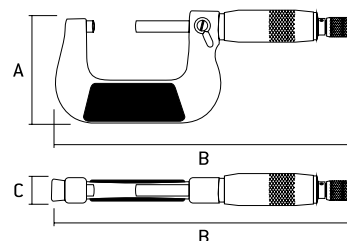

- Com catraca | With ratchet | Con carraca
- Fases de medição com metal duro | Measurement steps with carbide | Fases de medición con metal duro
- Uso Industrial | Industrial use | Uso Industrial
- Graduação de 0,01mm | Graduation of 0,01mm | Graduación de 0,01mm
- Embalagem: caixa plástica | Packing: plastic box | Embalaje: caja plástica

Esquadro
Square | Escuadro



antigo	novo	CS	KG	DIMENSÕES SIZE TAMAÑO (MM)			Quant. Min.	
				A	B	C		
323425	3234255	10" (250mm)	108g	130	250	15	120	12
323445	3234455	12" (300mm)	132g	130	300	15	120	12
323465	3234655	14" (350mm)	142g	150	350	15	120	12
323525	3235255	20" (500mm)	183g	150	500	15	120	12

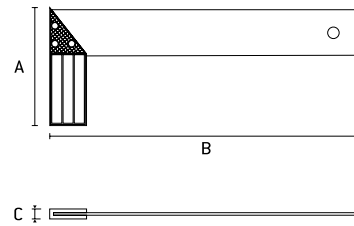

- Cabo de Alumínio | Aluminum Cable | Cable de aluminio
- Lâmina de Aço carbono | Carbon Steel Blade | Lámina de Acero de carbono

Esquadro Combinado (Uso Industrial)

Combined Square (Industrial Use) | Escuadrón Combinado (Uso Industrial)



	CS	KG	DIMENSÕES SIZE TAMAÑO (MM)			Quant. Min.	
			A	B	C		
3236755	12" (300mm)	292g	140	362	17	60	10

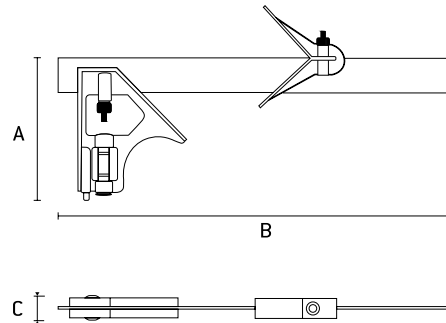

- Nível / Esquadro | Level / Square | Nivel / Escuadra
- Corpo / Base em alumínio fundido | Cast aluminum body / base | Cuerpo / Base de aluminio fundido
- Régua deslizante de aço inox | Stainless steel sliding ruler | Riego deslizante de acero inoxidable

Esquadro de Aço carbono

Carbon Steel Square | Escuadra de acero carbono



	CS	KG	DIMENSÕES SIZE TAMAÑO (MM)			Quant. Min.	
			A	B	C		
323709	12" (300mm)	240g	210	310	2	72	6
323719	24" (600mm)	721g	410	601	2	24	6

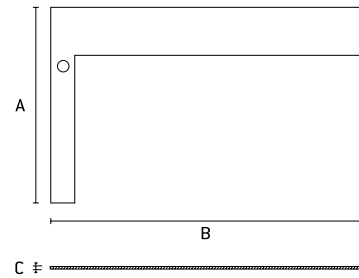

- Todo em aço carbono | All in carbon steel | Todo en acero al carbono

Esquadro de alumínio

Aluminum Square | Escuadra de aluminio



	CS	KG	DIMENSÕES SIZE TAMAÑO (MM)			Quant. Min.	
			A	B	C		
324719	10" (250mm)	158g	135	250	15	40	20
324729	12" (300mm)	188g	160	300	15	40	20
324739	14" (350mm)	225g	185	350	15	40	20
324749	16" (400mm)	263g	210	400	15	40	20

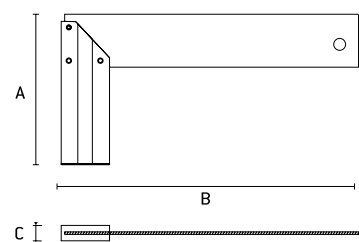

3

Nível de Alumínio 3 Bolhas

Level of Aluminum 3 Bubbles | Nivel de aluminio 3 burbujas



Código	Tamanho	Peso	DIMENSÕES SIZE TAMAÑO (MM)			Quant. Min.	
			A	B	C		
332179	10"(250mm)	100g	50	250	25	60	1
332189	12"(300mm)	135g	50	300	25	60	1
332199	14"(350mm)	150g	50	350	25	60	1
332209	16"(400mm)	194g	50	400	25	60	1
332239	24"(600mm)	259g	50	600	25	60	1
332269	32"(800mm)	318g	50	800	25	60	1
332299	40"(1000mm)	360g	50	1000	25	60	1
332389	71"(1800mm)	618g	50	1800	25	30	1*
332419	79"(2000mm)	733g	50	2000	25	30	1

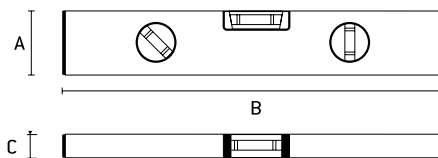

- Margem de erro permitida: 0,057° - 1 mm / 1m | Permitted error range: 0.057° - 1 mm / 1m | Margen de error permitido: 0,057° - 1 mm / 1m
- Alumínio | Aluminum | Aluminio
- Régua Graduada | Graduated Ruler | Régua Graduada
- 3 Bolhas | 3 Bubbles | 3 Burbujas

Nível de Alumínio Reforçado

Level of Aluminum | Nivel de aluminio



Código	Tamanho	Peso	DIMENSÕES SIZE TAMAÑO (MM)			Quant. Min.	
			A	B	C		
340049	16"(400mm)	333g	60	420	25	60	12
340069	24"(600mm)	431g	60	615	25	48	12
340089	32"(800mm)	553g	60	815	25	36	12
340109	40"(1000mm)	687g	60	1020	25	36	12

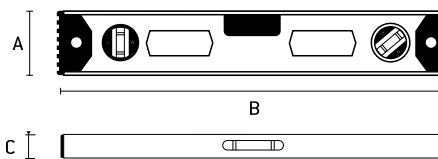

- Margem de erro permitida: 0,057° - 1 mm / 1m | Permitted error range: 0.057° - 1 mm / 1m | Margen de error permitido: 0,057° - 1 mm / 1m
- Alumínio | Aluminum | Aluminio
- 2 Bolhas / 1 Rotativa | 2 Bubbles / 1 Rotary | 2 Burbujas / 1 Rotativa
- Régua Graduada escala (mm e pol.) | Ruler graduated scale (mm and in.) | Regla Graduada escala (mm y pulg.)
- Reforçado | Reinforced | Reforzado



Bolha Rotativa
Rotary Bubble
Burbuja Rotativa

Nível de Alumínio

Level of Aluminum | Nivel de aluminio



Código	Tamanho	Peso	DIMENSÕES SIZE TAMAÑO (MM)			Quant. Min.	
			A	B	C		
340209	16"(400mm)	60g	60	400	25	60	12*
340389	71"(1800mm)	540g	60	1800	25	36	12*
340419	79"(2000mm)	583g	60	2000	25	36	12*

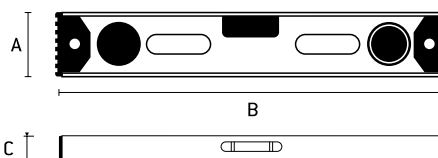

- Margem de erro permitida: 0,057° - 1 mm / 1m | Permitted error range: 0.057° - 1 mm / 1m | Margen de error permitido: 0,057° - 1 mm / 1m
- Alumínio | Aluminum | Aluminio
- 2 Bolhas / 1 Rotativa | 2 Bubbles / 1 Rotary | 2 Burbujas / 1 Rotativa
- Régua Graduada | Graduated Ruler | Régua Graduada
- Reforçado | Reinforced | Reforzado



Bolha Rotativa
Rotary Bubble
Burbuja Rotativa

Nível 2 bolhas

Level 2 bubbles | Nivel 2 burbujas



antigo	novo	kg	DIMENSÕES SIZE TAMAÑO (MM)			Quant. Min.		
			A	B	C			
	3510155	10"(250mm)	55g	47	250	17	60	1
	3510255	12"(300mm)	75g	47	300	17	60	1
	3510355	14"(350mm)	105g	47	350	17	60	1
35104	3510455	16"(400mm)	125g	47	400	17	60	1
35106	3510655	24"(600mm)	158g	47	600	17	60	1
35108	3510855	32"(800mm)	193g	47	800	17	60	1
35110	3511055	40"(1000mm)	233g	47	1000	17	30	1
35118		71"(1800mm)	500g	47	1800	17	30	1*
35120	3512055	79"(2000mm)	380g	47	2000	17	30	1

- Margem de erro permitida: 0,057° - 1 mm / 1m | Permitted error range: 0.057° - 1 mm / 1m | Margen de error permitido: 0,057° - 1 mm / 1m
- Alumínio | Aluminum | Aluminio
- Régua Graduada | Graduated Ruler | Régua Graduada

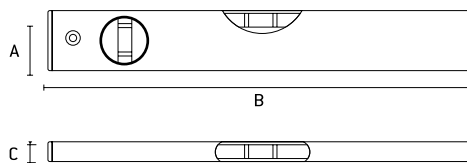

Nível de alumínio imantando

Level of aluminum magnetizing | Nivel de aluminio imantando



antigo	novo	kg	DIMENSÕES SIZE TAMAÑO (MM)			Quant. Min.		
			A	B	C			
	347049	16"(400mm)	305g	60	400	25	40	1
	347069	24"(600mm)	415g	60	600	25	40	1
	347089	32"(800mm)	545g	60	800	25	40	1
	347109	40"(1000mm)	640g	60	1000	25	40	1*
	347159	60"(1500mm)	910g	60	1500	25	20	1
	347209	80"(2000mm)	1225g	60	2000	25	20	1

- Margem de erro permitida: 0,057° - 1 mm / 1m | Permitted error range: 0.057° - 1 mm / 1m | Margen de error permitido: 0,057° - 1 mm / 1m
- Alumínio | Aluminum | Aluminio
- Imantado | Magnetized | Magnetizado
- 3 Bolhas | 3 Bubbles | 3 Burbujas
- Com 1 espelho | With 1 mirror | Con 1 espejo

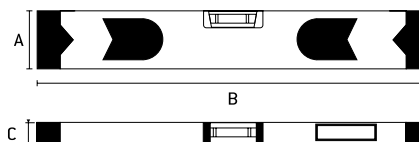

Nível Plástico imantado

Plastic Level magnetized | Nivel Plástico imantado



antigo	novo	kg	DIMENSÕES SIZE TAMAÑO (MM)			Quant. Min.		
			A	B	C			
	3461155	9 1/2"(230mm) torpedo	93g	15	230	40	120	20

- 3 Bolhas | 3 Bubbles | 3 Burbujas
- Formato Torpedo | Torpedo shape | Formato de Torpedo
- Imantado | Magnetized | Magnetizado

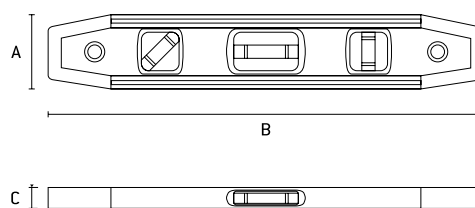

Nível Trapezoidal

Trapezoidal Level | Nivel Trapezoidal



antigo	novo	kg	DIMENSÕES SIZE TAMAÑO (MM)			Quant. Min.		
			A	B	C			
	349079	24"(600mm)	513g	5	600	20	40	1*

- Alumínio | Aluminum | Aluminio
- 2 Bolhas | 2 Bubbles | 2 Burbujas
- Com espelho | With mirror | Con espejo

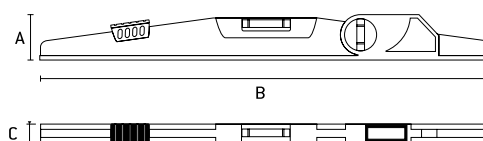

Nível a laser com prumo

Plummet and laser level | Prumo y nivel láser



350069



125g

DIMENSÕES | SIZE | TAMAÑO (MM)

A

B

C



Quant. Min.

1

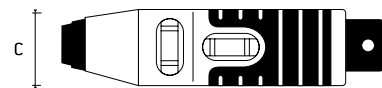
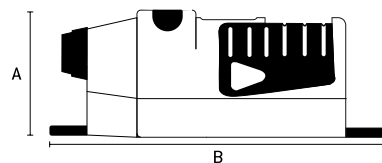

02 Bolhas de nivelamento

02 leveling bubbles

burbujas de nivelación

- Marcação de prumo | Plumb Tagging | Marcado de plomado
- Utilizados para verificar plano verticais e horizontais | Used to check vertical and horizontal planes | Utilizados para comprobar plan vertical y horizontal
- Embalagem: Plástica | Packing: Plastic | Embalaje: Plástico

Nível a laser esquadro

Level laser square | Nivel láser escuadra



350079



243g

DIMENSÕES | SIZE | TAMAÑO (MM)

A

B

C



Quant. Min.

1



Aplicação

Application

Aplicación



2 ventosas para fixação

2 suction cups

2 ventosas para fijación

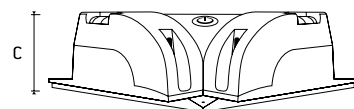
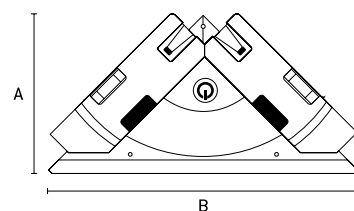

- Tipo de Marcação: Linha de ângulos | Marking Type: Line of Angles | Tipo de marcado: Línea de ângulos
- 03 Bolhas | 03 Bubbles | 03 Burbujas
- Embalagem: Caixa | Packing: Carton | Embalaje: Caja

Nível a laser para furação

Level laser square | Nivel láser escuadra



350409



5m



402g

DIMENSÕES | SIZE | TAMAÑO (MM)

A

B

C



Quant. Min.

1

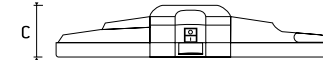
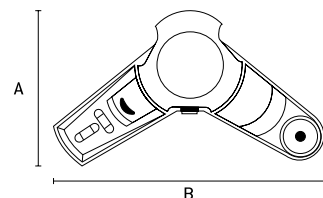

- Marcação para furação | Drilling marking | Marcado para perforación
- Coletor de pó | Dust collector | Colector de polvo
- 2 Bolhas | 2 Bubbles | 2 Burbujas
- Diâmetro máximo 10mm | Maximum diameter 10mm | Diámetro máximo 10mm
- Ideal para acabamentos de instalações | Ideal for finishing installations | Ideal para acabados de instalaciones
- Protetor plástico na parte inferior | Plastic protector on the bottom | Protector plástico en la parte inferior
- Embalagem: Caixa | Packing: Carton | Embalaje: Caja



Aplicação

Application

Aplicación

Prumo / Nível a Laser com tripé

Plumb / Laser Level with Tripod | Prumo / Nivel a laser con trípode



350229



213g

DIMENSÕES | SIZE | TAMAÑO (MM)

A	B	C
125	240	35



Quant. Min.

10

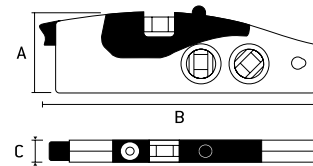

- Magnético | Magnetic | Magnético
- Marcação em vertical e horizontal | Cross marking | Marcado en cruz
- Altura do tripé 220mm | Tripod height 220mm | Altura del trípode 220mm
- 4 bolhas | 4 Bubbles | 4 Burbujas
- Embalagem: Blister | Packing: Blister | Embalaje: Blister
- Alcance da marcação em cruz 10 metros | Cross-marking range 10 meters | Alcance del marcado en cruz 10 metros
- Alcance da marcação em ponto 50 metros | Point-marking range 50 meters | Alcance del marcado en punto 50 metros



Magnético
Magnetic
Magnético



Nível a laser com tripé

Laser Level with Tripod | Nivel láser con trípode



350209



10m



195g

DIMENSÕES | SIZE | TAMAÑO (MM)

A	B	C
124	242	30



Quant. Min.

10*

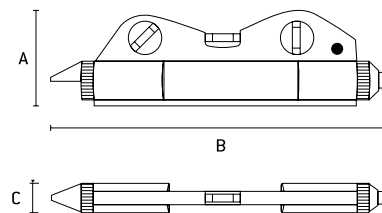

- Magnético | Magnetic | Magnético
- Altura do tripé 150mm | Tripod height 150mm | Altura del trípode 150mm
- 3 Bolhas | 3 Bubbles | 3 Burbujas
- Embalagem: Blister | Packing: Blister | Embalaje: Blister

Nível a laser com tripé

Laser Level with Tripod | Nivel láser con trípode



350299



10m



2415g

DIMENSÕES | SIZE | TAMAÑO (MM)

A	B	C
100	545	165



Quant. Min.

1*

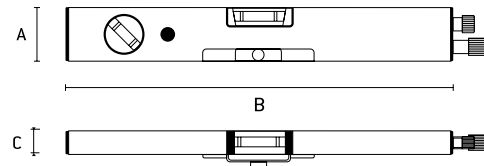

- Altura do tripé 1050mm | Tripod height 1050mm | Altura del trípode 1050mm
- Marcação | Marking | Marcando
- 3 Bolhas | 3 Bubbles | 3 Burbujas
- Embalagem: Plástica | Packing: Plastic | Embalaje: Plástico

Medidor de distância a laser Laser Distance Meter | Medidor de distancia láser



38001	70m	345g	DIMENSÕES SIZE TAMAÑO (MM) A B C 20	Quant. Min. 1*

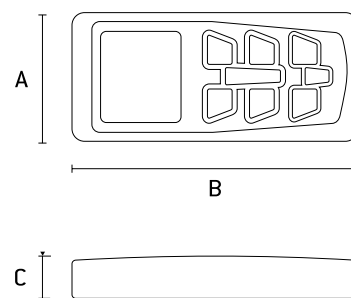

- Profissional | Professional | Profesional
- Revestimento protetor para trena | Protective coating for treadmill | Revestimiento protector para trena
- Unidades de medição: mm/cm - pés / pelegada | Measuring units: mm / cm - feet / inches | Unidades de medición: mm / cm - pies / pelegada
- Amplitude de medição: 0,05 - 70 mts | Measuring range: 0.05 - 70 m | Amplitud de medición: 0,05 - 70 mts
- Precisão de medição $\pm 1,5\text{mm}$ | Measuring accuracy $\pm 1,5\text{mm}$ | Precisión de medición $\pm 1,5\text{mm}$
- Medições retas, angulares (altura) e cúbicas | Straight, angular (height) and cubic measurements | Mediciones rectas, angulares (altura) y cúbicas
- Caneta de marcação | Marking pen | Pluma de marcado
- Capacidade de armazenamento: 20 valores de medição | Storage capacity: 20 measurement values | Capacidad de almacenamiento: 20 valores de medición
- Alça de nylon para transporte | Nylon carrying handle | Alza de nylon para transporte
- Embalagem: Caixa, protetor trena, pilhas e bolsa com porta cintos | Packing: Case, strap protector, batteries and bag with belt strap | Embalaje: Caja, protector trena, pilas y bolsa con puerta cinturones

Nível de canto Level of corner | Nivel de esquina



348205	135g	DIMENSÕES SIZE TAMAÑO (MM) A B 100	20	Quant. Min. 20

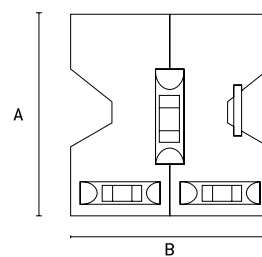

- Plástico | Plastic | Plástico
- Magnético | Magnetic | Magnético
- 3 Bolhas de medição | 3 Measuring bubbles | 3 Burbujas de medición
- Embalagem: Caixa | Packing: Carton | Embalaje: Caja



Aplicação
Application
Aplicación

Tripé

Tripod | Trípode



			DIMENSÕES SIZE TAMAÑO (MM)			
350909	420 - 1260mm	910g	A	420 a 1260mm	10	1

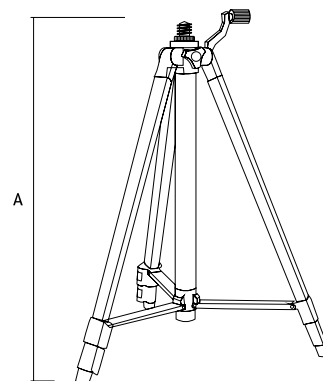

- Alumínio | Aluminum | Aluminio
- Ajuste de altura | Height Adjustment | Ajuste de altura
- Elevação 420 - 1260 mm | Elevation 420 - 1260 mm | Elevación 420 - 1260 mm
- Rosca 5/8" | Thread 5/8 " | Rosca 5/8 "
- Acessório para produtos: 350339 e 350359 | Accessory for products: 350339 and 350359 | Accesorio para productos: 350339 y 350359

Nível a Laser de alta precisão com tripé

High Precision Laser Level with Tripod | Nivel láser de alta precisión con trípode



			DIMENSÕES SIZE TAMAÑO (MM)			
350339	10m	2863g	A	B	4	1



Base giratória (regulável) 360°
Swivel base (adjustable) 360°
Base giratoria (ajustable) 360°

Maleta com o Nível e os acessórios
Suitcase with the Levels of the Accessories
Maleta con Nivel e os acessórios

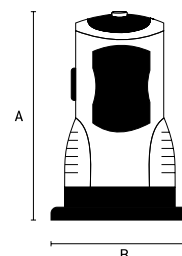

Distância aproximada de operação: ~10m
Approximate operating distance: ~ 10m
Distancia aproximada de funcionamiento: ~ 10m

Potência do laser: 1nW
Laser power: 1nW
Potencia del laser: 1nW

Comprimento da onda do laser: 650nm
Laser wave length: 650nm
Longitud de la onda del laser: 650nm

Alimentação: 3 Pilhas AA 1,5V
Power: 3 AA batteries 1,5V
Alimentación: 3 pilas AA 1,5V



- Alta precisão de onda horizontal e vertical: ~2nW/m | High horizontal and vertical wave precision: ~ 2nW / m | Alta precisión de onda horizontal y vertical: ~ 2nW / m
- Auto nivelamento | Auto leveling | Auto nivelación
- Marcação em cruz | Cross marking | Marcado en cruz
- Óculos de proteção | Protective goggles | Anteojos de protección
- Altura tripé 1100m, rosca 5/8" | Tripod height 1100m, thread 5/8 " | Altura de trípode 1100m, rosca 5/8 "
- 3 bolhas | 3 bubbles | 3 burbujas
- Embalagem: Caixa Plástica | Packing: Plastic Box | Embalaje: Caja Plástica

NÍVEL A LASER 5 LINHAS

5 LEVEL LASER LEVEL | NIVEL A LASER 5 LÍNEAS

			DIMENSÕES SIZE TAMAÑO (MM)			
350359	10m	2333g	A	B	6	1



DESCRIÇÃO

- Alcance: 10m ambientes internos
- Aviso sonoro de desnivelamento
- Possui 3 bolhas de nivelamento
- Utiliza 3 Pilhas AA (incluso)
- Fonte Bivolt (incluso)
- Óculos para melhor visualização do laser (incluso)
- Acompanha maleta para transporte

DESCRIPTION

- Range: 10m indoor environments
- Unbalanced sound warning
- It has 3 leveling bubbles
- Uses 3 AA batteries (included)
- Bivolt Source (included)
- Glasses for better visualization of the laser (included)
- Carrying case included

DESCRIPCIÓN

- Alcance: 10m ambientes internos
- Advertencia sonora de desnivel
- Tiene 3 burbujas de nivelación
- Utiliza 3 pilas AA (incluidas)
- Fuente Bivolt (incluido)
- Gafas para una mejor visualización del láser (incluido)
- Acompaña maletín para transporte

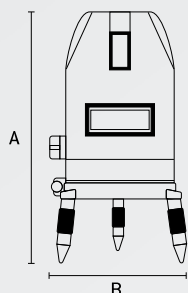

LIGA E DESLIGA

- ON AND OFF
- LIGA Y APAGADO

AJUSTE PRECISO 360°

- 360° PRECISION ADJUSTMENT
- 360° PRECISION ADJUSTMENT

- Comprimento da onda do laser: 650nm
- Laser wave length: 650nm
- Longitud de la onda del laser: 650nm
- Nível de Precisão +/- 0,5mm/5m
- Accuracy Level +/- 0.5mm / 5m
- Nivel de precisión +/- 0,5mm / 5m
- Desvio do angulo direito 90° a +/- 1°
- Deviation from right angle 90° to +/- 1°
- Desviación del ángulo derecho 90° a +/- 1°

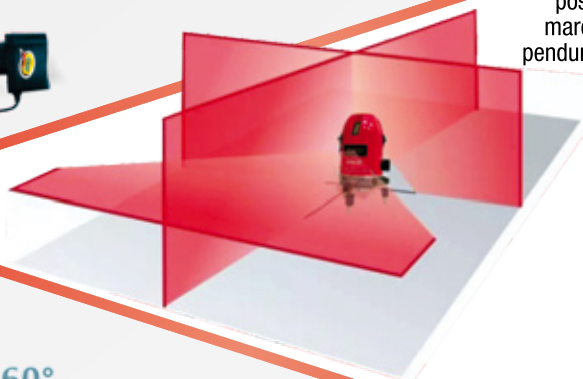

4 SAÍDAS DE LINHAS VERTICAIS

- 4 OUTPUTS OF VERTICAL LINES
- 4 SALIDAS DE LÍNEAS VERTICALES

SAÍDA DE LINHA HORIZONTAL

- HORIZONTAL LINE OUTPUT
- SALIDA DE LÍNEA HORIZONTAL

BASE AJUSTÁVEL

- ADJUSTABLE BASE
- BASE AJUSTABLE

PAINEL FRONTAL

BOLHA DE NÍVEL ILUMINADO

- ILLUMINATED LEVEL BUBBLE
- BURBUJA DE NIVEL ILUMINADO

LINHA HORIZONTAL

- HORIZONTAL LINE
- LÍNEA HORIZONTAL

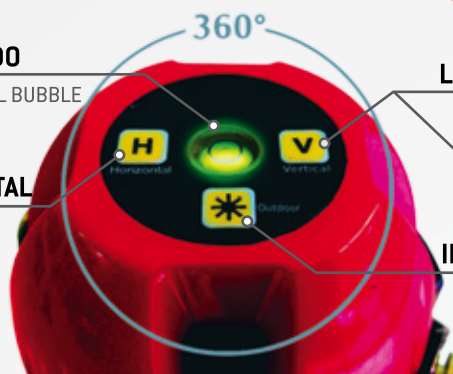

LINHA VERTICAL

- VERTICAL LINE
- LÍNEA VERTICAL

CLIQUE DUPLO PARA ACIONAMENTO DAS 4 LINHAS VERTICAIS

- DOUBLE CLICK FOR TRANSFER OF 4 VERTICAL LINES
- CLIQUE DOBLE PARA ACCIONAMIENTO DE LAS 4 LÍNEAS VERTICALES

INTENSIDADE DO LASER

- LASER INTENSITY
- INTENSIDAD DEL LÁSER

- **Nível Laser MTX** projeta em qualquer superfície, rápido e sem riscar.
- A ferramenta é utilizada para calibrar as posições corretas relativas dos objetos na distância, marcando as bases. Perfeito para instalar prateleiras, pendurar quadros, colocar portas, azulejos, janelas, etc.

- MTX Laser Level projects in any surface, fast and without scratching.
- The tool is used to calibrate the relative positions of objects in the distance, marking the bases. Perfect for installing shelves, hang frames, put doors, tiles, windows, etc.

- Nivel láser MTX proyecta en cualquier superficie, rápido y sin rayar.
- La herramienta se utiliza para calibrar las posiciones correctas relativas de los objetos en la distancia, marcando las bases. Perfecto para instalar estantes, colgar cuadros, colocar puertas, azulejos, ventanas, etc.



FERRAMENTAS DE MONTAGEM

ASSEMBLY'S TOOLS
HERRAMIENTAS DE MONTAJE

As ferramentas de montagem GROSS, MTX proporcionam a ergonomia apropriada ao trabalho a ser desenvolvido. Utilizando matérias primas de qualidade as ferramentas tem um ótimo desempenho e proporcionam um excelente resultado tanto para profissionais quanto para amadores. Toda a ferramenta é testada para realizar o trabalho com perfeição e confiança.

The GROSS, MTX assembly tools provide the appropriate ergonomics for the work to be done. Utilizing quality raw materials the tools have a great performance and provide an excellent result for both professionals and amateurs. The entire tool is tested to perform the job with perfection and confidence.

Las herramientas de montaje GROSS, MTX proporcionan la ergonomía apropiada al trabajo a ser desarrollado. Utilizando materias primas de calidad las herramientas tienen un óptimo desempeño y proporcionan un excelente resultado tanto para profesionales como para aficionados. Toda la herramienta se prueba para realizar el trabajo con la perfección y la confianza.

SIMBOLOGIA



CÓDIGO
CODE



CARACTERÍSTICAS
Technical Features



PESO DA PEÇA
Part Weight
Peso de la Pieza



CAIXA MASTER
Box Master | Caja Máster



QUANT. MINÍMA
Quant. Minimum
Cantidad Mínimo

Rebitador Manual Profissional

Professional Manual Riveter | Rebajador Manual Profesional



40405



285mm



840g

DIMENSÕES | SIZE | TAMAÑO (MM)

A

B

C



Quant. Min.

20

10*



BLISTER



Aplicação Gancho ajustável para medições internas e externas

Adjustable hook for internal and external measurements

Gancho ajustable para mediciones internas y externas

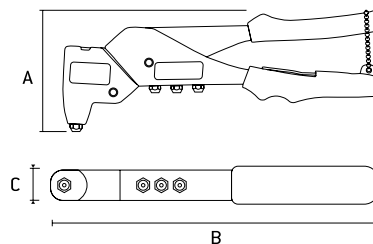

- Rebitos | Rivets | Remaches 2,4 | 3,0 | 3,2 | 4,0 | 4,8 | 5,0 mm
- Indicado para unir peças como: chapas, tubos, perfis através de rebites de repuxo | Suitable for joining parts such as: plates, pipes, profiles through fissure rivets | Indicado para unir piezas como: chapas, tubos, perfiles a través de remaches de repuesto
- Corpo em chapa de aço fundido | Body in cast steel sheet | Cuerpo en chapa de acero fundido
- Rebites de alumínio e de aço | Aluminum and steel rivets | Rejillas de aluminio y de acero
- Embalagem: Blister | Packing: Blister | Embalaje: Blister

Rebitador Tipo Alicete

Riveter Pliers Type | Rebajador Tipo Alicate



405279



250mm



725g

DIMENSÕES | SIZE | TAMAÑO (MM)

A

B

C



Quant. Min.

24

1



BLISTER



• 405279



Cabeça ajustável 0-90°

Adjustable head 0-90°

Cabeza ajustable 0-90°

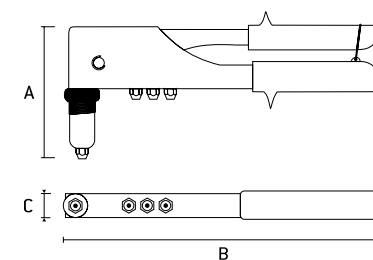

• 405339



Cabeça giratória 0-360°

Swivel head 0-360°

Cabeza giratoria 0-360°

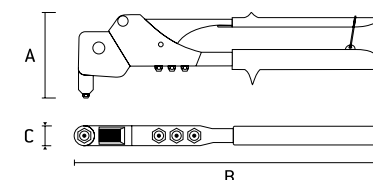

- Rebitos | Rivets | Remaches 2,4 | 3,2 | 4,0 | 4,8 mm
- Indicado para unir peças como: chapas, tubos, perfis através de rebites de repuxo | Suitable for joining parts such as: plates, pipes, profiles through fissure rivets | Indicado para unir piezas como: chapas, tubos, perfiles a través de remaches de repuesto
- Corpo em chapa de aço fundido | Body in cast steel sheet | Cuerpo en chapa de acero fundido
- Rebites de alumínio e de aço | Aluminum and steel rivets | Rejillas de aluminio y de acero
- Embalagem: Blister | Packing: Blister | Embalaje: Blister

Rebitador Manual Tipo Alicate

Manual Riveter Pliers Type | Rebajador Manual Tipo Alicate



• 405159

• 405249

Barcode	kg	DIMENSÕES SIZE TAMAÑO (MM)			Quant. Min.		
		A	B	C			
405159	225mm	542g	130	225	30	24	1
405249	250mm	583g	130	250	30	24	1

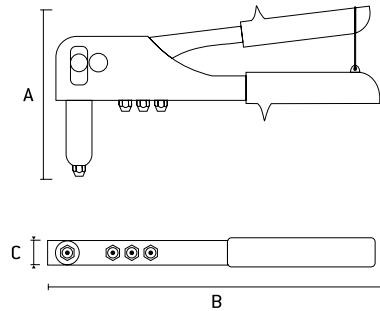

- Rebitos | Rivets | Remaches 2,4 | 3,2 | 4,0 | 4,8 mm
- Indicado para unir peças como: chapas, tubos, perfis através de rebites de repuxo | Suitable for joining parts such as: plates, pipes, profiles through fissure rivets | Indicado para unir piezas como: chapas, tubos, perfiles a través de remaches de repuesto
- Corpo em chapa de aço fundido | Body in cast steel sheet | Cuerpo en chapa de acero fundido
- Rebitos de alumínio e de aço | Aluminum and steel rivets | Rejillas de aluminio y de acero
- Embalagem: Blister | Packing: Blister | Embalaje: Blister

Rebitador Manual Tipo Alavanca

Manual Riveter Type Lever | Rebajador Manual Tipo Palanca



Barcode	kg	DIMENSÕES SIZE TAMAÑO (MM)			Quant. Min.		
		A	B	C			
405359	500mm	2030g	175	540	45	10	1

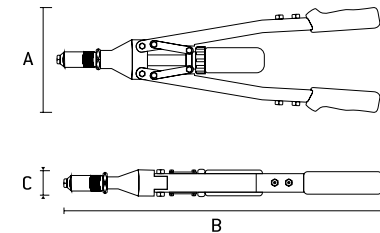

- Rebitos | Rivets | Remaches | 3,2 | 4,0 | 4,8 | 6,0 | 6,4 mm
- Indicado para unir peças como: chapas, tubos, perfis através de rebites de repuxo | Suitable for joining parts such as: plates, pipes, profiles through fissure rivets | Indicado para unir piezas como: chapas, tubos, perfiles a través de remaches de repuesto
- Embalagem: Caixa | Packing: Box | Embalaje: Caja

Rebitador Manual Tipo Alavanca

Manual Riveter Type Lever | Rebajador Manual Tipo Palanca



Barcode	kg	DIMENSÕES SIZE TAMAÑO (MM)			Quant. Min.		
		A	B	C			
405385	450 mm	930g	110	450	35	10	1

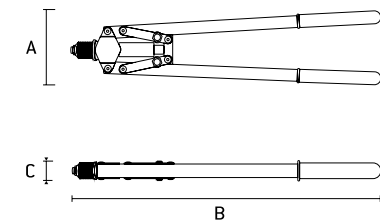

- Rebitos | Rivets | Remaches | 3,2 | 4,0 | 4,8 | 6,0 mm
- Indicado para unir peças como: chapas, tubos, perfis através de rebites de repuxo | Suitable for joining parts such as: plates, pipes, profiles through fissure rivets | Indicado para unir piezas como: chapas, tubos, perfiles a través de remaches de repuesto
- Embalagem: Caixa | Packing: Box | Embalaje: Caja



Grampeador e Pinador manual - Profissional

Stapler and Manual Pincher - Professional | Grapadora y Pinador manual - Profesional



BLISTER



409019	908g	DIMENSÕES SIZE TAMAÑO (MM)			24	Quant. Min.
		A	B	C		

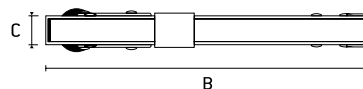
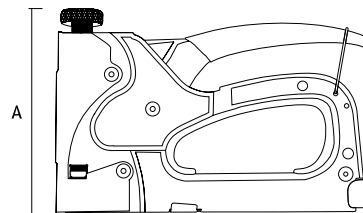

- Grampos e Pinos Tipo | Clamps and Pins Type | Grapas y Perros Tipo: 36, 140, 300, 500
- Para utilização em estofarias | For use on upholstery | Para uso en tapizados
- Ajuste de pressão | Pressure adjustment | Ajuste de presión
- Uso profissional | Professional use | Uso profesional
- Para grampos de 6 - 14mm | For 6 - 14mm clamps | Para grapas de 6 - 14mm
- Corpo em chapa de aço cromado | Chrome plated steel body | Cuerpo en chapa de acero cromado
- Embalagem: Blister | Packing: Blister | Embalaje: Blister
- Acompanha Grampos | Accompany Clamps | Acompaña Clips

Grampeador Tapeceiro | Controle de Pressão

Stapler Upholsterer | Pressure Control | Grapadora Tapicería | Control de Presión



BLISTER



409029	650g	DIMENSÕES SIZE TAMAÑO (MM)			40	Quant. Min.
		A	B	C		

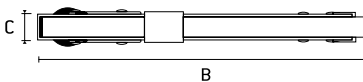
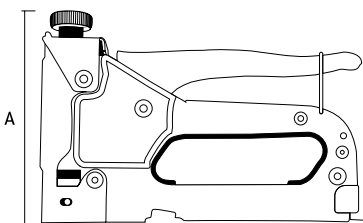

- Para utilização em estofarias | For use on upholstery | Para uso en tapizados
- Ajuste de pressão | Pressure adjustment | Ajuste de presión
- Para grampos tipo 53 de 4 - 14mm | For clamps type 53 in 4 - 14mm | Para grapas tipo 53 de 4 - 14mm
- Corpo em chapa de aço cromado | Chrome plated steel body | Cuerpo en chapa de acero cromado
- Embalagem: Blister | Packing: Blister | Embalaje: Blister
- Acompanha Grampos | Accompany Clamps | Acompaña Clips

Grampeador Tapeceiro

Stapler Upholsterer | Grapadora Tapicería



BLISTER



409039	475g	DIMENSÕES SIZE TAMAÑO (MM)			40	Quant. Min.
		A	B	C		

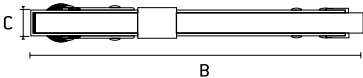
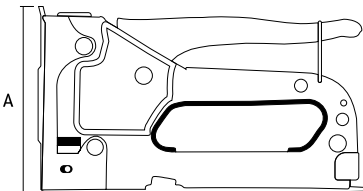

- Para utilização em estofarias | For use on upholstery | Para uso en tapizados
- Para grampos tipo 53 de 4-8 mm | For Type 53 Clips | Para grapas tipo 53
- Corpo em chapa de aço cromado | Chrome plated steel body | Cuerpo en chapa de acero cromado
- Embalagem: Blister | Packing: Blister | Embalaje: Blister
- Acompanha Grampos | Accompany Clamps | Acompaña Clips

Grampeador Tapeceiro de Plástico

Stapler Upholsterer Plastic | Grapadora Tapicería de Plástico



409079



250g

DIMENSÕES | SIZE | TAMAÑO (MM)

A

B

C



80



20



BLISTER

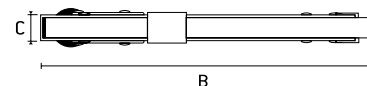
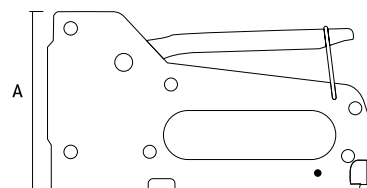

- Para utilização em estofarias | For use on upholstery | Para uso en tapizados
- 4 Para grampos tipo 53 de 4 - 8mm | For 4 - 8mm clamps | Para grapas de 4 - 8mm
- Embalagem: Blister | Packing: Blister | Embalaje: Blister
- Corpo Plástico | Plastic Body | Cuerpo Plástico

Grampeador Tapeceiro Reforçado

Stapler Upholsterer Reinforced | Grapadora Tapicería reforzada



41000



605g

DIMENSÕES | SIZE | TAMAÑO (MM)

A

B

C



40



10*



BLISTER

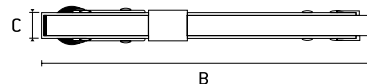
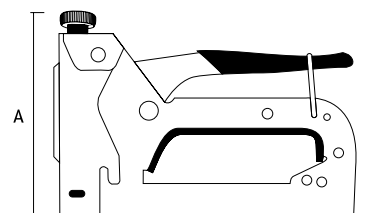

- Ajuste de Pressão | Pressure Adjustment | Ajuste de presión
- Cabo emborrachado | Rubberized cable | Cable de goma
- Corpo de metal reforçado | Reinforced metal body | Cuerpo de metal reforzado
- Grampo tipo 53 (4-14mm) | Type 53 clip (4-14mm) | Grapa tipo 53 (4-14mm)
- Embalagem: Blister | Packing: Blister | Embalaje: Blister

Grampeador Manual

Manual Stapler | Grapadora manual



42003



4200355



950g



20



5

AUTO SERVIÇO



- Kit Contém | Kit Contains | Kit Contiene
- Grampeador (6-14mm) | Stapler (6-14mm) | Grapadora (6-14mm)
- Trena de 2mt x 13mm | Measuring tape 2 mt x 13mm | Trena de 2 mt x 13mm
- 500 grampos tipo 53 (8mm) | 500 cli ps type 53 (8mm) | 500 grapas ti po 53 (8mm)

Extrator de grampos

Staple Remover | Extractor de grapas



409129	universal	143g	DIMENSÕES SIZE TAMAÑO (MM)			84	42
			A	B	C		



BLISTER

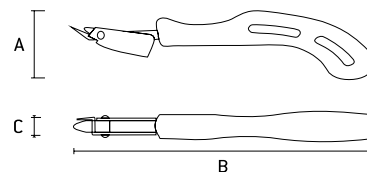

Grampos

Clamp | Grapa



411169	6 mm - tipo 53	6	11,3	0,7	300	1
411189	8 mm - tipo 53	8	11,3	0,7	300	1
411209	10 mm - tipo 53	10	11,3	0,7	240	1
411229	12 mm - tipo 53	12	11,3	0,7	180	1
411249	14 mm - tipo 53	14	11,3	0,7	180	1



• Tipo | Type 53

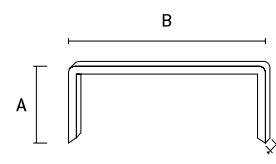

10,6

• Embalagem caixa com 1000 peças | Packing box with 1000 pieces | Embalaje caja con 1000 piezas

Grampos Temperados

Clamp | Grapa



412069	6 mm - tipo 53	6	11,3	0,7	300	1
412089	8 mm - tipo 53	8	11,3	0,7	300	1
412109	10 mm - tipo 53	10	11,3	0,7	240	1
412129	12 mm - tipo 53	12	11,3	0,7	180	1
412149	14 mm - tipo 53	14	11,3	0,7	180	1
413069	6 mm - tipo 140	6	10,6	1,25	200	1
413089	8 mm - tipo 140	8	10,6	1,25	180	1
413109	10 mm - tipo 140	10	10,6	1,25	150	1
413129	12 mm - tipo 140	12	10,6	1,25	120	1
413149	14 mm - tipo 140	14	10,6	1,25	120	1
414129	12 mm - tipo 36 U	12	7,74	1,25	150	1
414149	14 mm - tipo 36 U	14	7,74	1,25	120	1



• Tipo | Type 53



• Tipo | Type 140



• Tipo | Type 36 U

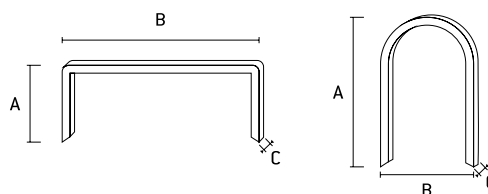

• Temperados | Tempered | Sazonado

• Embalagem caixa com 1000 peças | Packing box with 1000 pieces | Embalaje caja con 1000 piezas

Pinos para pinadores manuais

Staple Remover | Extractor de grapas



415109	10 mm - Tipo 300 T-VT	0,088g	10	1,25	1	250	1
415129	12 mm - Tipo 300 T-VT	0,105g	12	1,25	1	250	1
415149	14 mm - Tipo 300 T-VT	0,126g	14	1,25	1	250	1

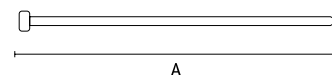
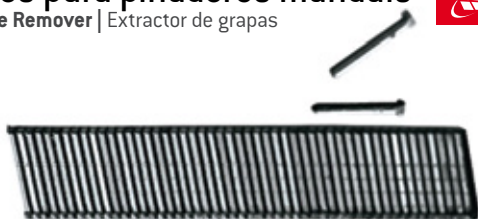

• Tipo | Type 300 T-VT

• Com Cabeça | With head | Con Cabeza

• Embalagem caixa com 1000 peças | Packing box with 1000 pieces | Embalaje caja con 1000 piezas

Rebites de repuxo

Flake rivets | Rejillas de repuesto



Código	Dimensões	Peso	DIMENSÕES SIZE TAMAÑO (MM)		Quant. Min.
			A	B	
406109	3,2 x 6 mm	0,050g	3,2	6	400
406209	3,2 x 8 mm	0,052g	3,2	8	400
406259	3,2 x 10 mm	0,052g	3,2	10	400
406279	3,2 x 12 mm	0,057g	3,2	12	400
406319	4,0 x 6 mm	0,070g	4,0	6	200
406329	4,0 x 8 mm	0,076g	4,0	8	200
406359	4,0 x 10 mm	0,078g	4,0	10	200
406409	4,0 x 12 mm	0,084g	4,0	12	200
406439	4,0 x 14 mm	0,090g	4,0	14	200
406459	4,0 x 16 mm	0,091g	4,0	16	200
406509	4,8 x 8 mm	0,110g	4,8	8	200
406559	4,8 x 10 mm	0,120g	4,8	10	200
406609	4,8 x 12 mm	0,125g	4,8	12	200
406639	4,8 x 14 mm	0,132g	4,8	14	100
406659	4,8 x 16 mm	0,143g	4,8	16	100

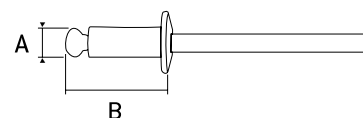

- Corpo Alumínio | Body Aluminum | Cuerpo Aluminio
- Embalagem: pacotes com 50 peças | Packing: packages with 50 pieces | Embalaje: paquetes con 50 piezas

Pinos para pinadores pneumáticos

Pines | Pinos



Código	Dimensões	Peso	DIMENSÕES SIZE TAMAÑO (MM)			Quant. Min.
			A	B	C	
576029	10 mm - 18GA - cx 5000 pçs	450g	10	1,25	1	20
576049	15 mm - 18GA - cx 5000 pçs	750g	15	1,25	1	20
576069	20 mm - 18GA - cx 5000 pçs	823g	20	1,25	1	20
576089	25 mm - 18GA - cx 5000 pçs	1075g	25	1,25	1	20
576109	30 mm - 18GA - cx 5000 pçs	1300g	30	1,25	1	20
576149	35 mm - 18GA - cx 5000 pçs	1500g	35	1,25	1	10
576169	40 mm - 18GA - cx 5000 pçs	1700g	40	1,25	1	10
576209	50 mm - 18GA - cx 5000 pçs	2020g	50	1,25	1	10

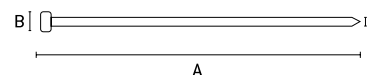

- Largura 1,25mm | Width 1,25mm | Ancho 1,25mm
- Espessura 1mm | Thickness 1mm | Espesor 1mm
- Caixa com 5.000 peças | Box with 5,000 pieces | Caja con 5.000 piezas

Grampos para grampeadores pneumáticos

Bobby pins | Clips



Código	Dimensões	Peso	DIMENSÕES SIZE TAMAÑO (MM)			Quant. Min.
			A	B	C	
576529	6 mm - 20GA - cx 5000 pçs	500g	6	1,25	1	30
576549	8 mm - 20GA - cx 5000 pçs	600g	8	1,25	1	30
576569	10 mm - 20GA - cx 5000 pçs	700g	10	1,25	1	30
576609	16 mm - 20GA - cx 5000 pçs	933g	16	1,25	1	15
576649	22 mm - 20GA - cx 5000 pçs	1300g	22	1,25	1	15

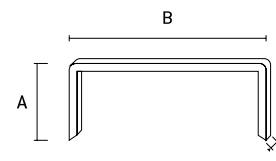





- Largura 11,2mm | Width 11,2mm | Ancho 11,2mm
- Espessura 0,6mm | Thickness 0,6mm | Espesor 0,6mm
- Caixa com 5.000 peças | Box with 5,000 pieces | Caja con 5.000 piezas



Pinador Pneumático para pinos 10-50mm

Pneumatic Pincher/10-50mm | Pintor Neumático/10-50mm



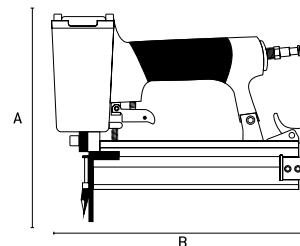

			DIMENSÕES SIZE TAMAÑO (MM)			
574109	10 - 50mm	1120g	A	B	10	1



• Pressão de trabalho: 7 BAR (100 PSI)

Grampeador Pneumático para grampos 10 - 22 mm

Pneumatic Stapler | Grapadora Neumática

			DIMENSÕES SIZE TAMAÑO (MM)			
574209	10 - 22mm	1483g	A	B	10	1

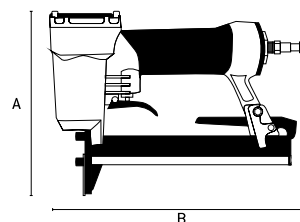

• Pressão de trabalho: 7 BAR (100 PSI)



AUTOMOTIVA

AUTOMOTIVE | AUTOMOTOR

FERRAMENTAS AUTOMOTIVAS

AUTOMOTIVE'S TOOLS
HERRAMIENTAS AUTOMOTORES

As ferramentas automotivas MTX e Sparta proporcionam a ergonomia apropriada ao trabalho a ser desenvolvido. Utilizando matérias primas de qualidade as ferramentas tem um ótimo desempenho e proporcionam um excelente resultado tanto para profissionais quanto para amadores.

MTX and Sparta automotive tools provide the right ergonomics for the work to be done. Utilizing quality raw materials the tools have a great performance and provide an excellent result for both professionals and amateurs.

Las herramientas automotrices MTX y Sparta proporcionan la ergonomía apropiada al trabajo a ser desarrollado. Utilizando materias primas de calidad las herramientas tienen un óptimo desempeño y proporcionan un excelente resultado tanto para profesionales como para aficionados.

SIMBOLOGIA



CÓDIGO
CODE



CARACTERÍSTICAS
Technical Features



PESO DA PEÇA
Part Weight
Peso de la Pieza



CAIXA MASTER
Box Master | Caja Máster



QUANT. MINÍMA
Quant. Minimum
Cantidad Mínimo



Soquete para vela estriado 1/2"

Socket for candle | Enchufe para la vela



Barcode	Description	Weight (KG)	DIMENSÕES SIZE TAMANHO (MM)		Box Qty	Quant. Min.
			A	B		
13187	ESTRIADO 14MM	124g	14	134	96	24
13188	ESTRIADO 16MM	109g	16	135	96	24
13189	ESTRIADO 21MM	162g	21	133	96	24

CrV
Alta
Qualidade

AUTO
SERVIÇO

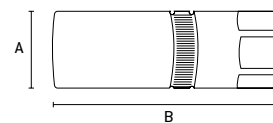

- Acabamento Polido | Polished Finish | Acabado Pulido
- Encaixe 1/2" | Fitting 1/2" | Encaje 1/2"
- Com imã | With magnet | Con el imán

Jogo de Soquetes 1/2"

Socket Set | Juego de Enchufe



Barcode	Description	Weight (KG)	DIMENSÕES SIZE TAMANHO (MM)		Box Qty	Quant. Min.
			Ø			
13513	17 19 21	840g	17	20	1*	
			19			
			21			

HEX

CrMo
STAHL



- Indicado para utilização em ferramentas pneumáticas | Suitable for use on pneumatic tools | Indicado para uso en herramientas neumáticas
- Resistente a impactos | Impact resistant | Resistente a impactos
- Encaixe 1/2" | 1/2" fitting | Enganche 1/2"

Soquetes Estriado

Striated Sockets | Enchufe Estriado



Barcode	Barcode	Description	Weight (KG)	DIMENSÕES SIZE TAMANHO (MM)		Box Qty	Quant. Min.
				A	B		
13636	1363655	ESTRIADO 16 mm	94g	16	65	240	40
13637	1363755	ESTRIADO 21 mm	141g	21	65	150	25

BIHEX

CrV
Alta
Qualidade

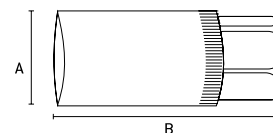

- Longo | Long | Largo
- Encaixe quadrado 1/2" | Square fitting 1/2" | Encaje cuadrado 1/2"

Jogo de Soquetes | Multifuncional
Socket Set Multifuncional | Juego de Enchufe multifuncional



antigo	novo	encaixe	KG	DIMENSÕES SIZE TAMAÑO (MM)		Quant. Min.	
				A	B		
13190	1319055	encaixe 1/2"	675g	11-32	153	20	10
13191	1319155	encaixe 3/8"	191g	6-21	123	96	12

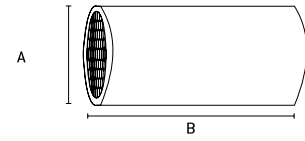

Ajustável a várias cabeças de parafusos
Adjustable to multiple screw heads
Ajustable a varias cabeças de tornillo

• Acabamento Polido | Polished Finish | Acabado Pulido

Soquetes Sextavados Temperados 1/2"

Tempered Hexagonal Sockets | Enchufes Sexto Templado



antigo	novo	KG	DIMENSÕES SIZE TAMAÑO (MM)		Quant. Min.	
			A	B		
1380855	8 mm	55g	50	8	200	10
1380955	9 mm	55g	50	9	200	10
1381055	10 mm	55g	50	10	200	10
1381155	11 mm	55g	50	11	200	10
1381255	12 mm	55g	20	12	200	10
1381355	13 mm	63g	50	13	200	20
1381455	14 mm	63g	50	14	200	10
1381555	15 mm	65g	50	15	200	10
1381655	16 mm	65g	25	16	200	10
1381755	17 mm	75g	20	17	160	8
1381855	18 mm	75g	50	18	160	8
1381955	19 mm	81g	50	19	160	8
1382055	20 mm	88g	25	20	160	8
1382155	21 mm	94g	50	21	160	8
1382255	22 mm	106g	50	22	160	8
1382355	23 mm	117g	50	23	120	6
1382455	24 mm	121g	50	24	120	5
1382655	26 mm	165g	30	26	100	5
1382755	27 mm	175g	50	27	100	5
1382855	28 mm	200g	40	28	80	4
1383055	30 mm	213g	50	30	80	4
1383255	32 mm	200g	50	32	80	4
1384555	3/8"	55g	3/8"	100	200	10
1384655	7/16"	55g	7/16"	40	200	10
1384755	1/2"	55g	1/2"	100	200	20
1384855	9/16"	63g	9/16"	100	200	10
1384955	5/8"	65g	5/8"	100	200	10
1385055	11/16"	75g	11/16"	40	160	8
1385155	3/4"	75g	3/4"	100	160	8
1385255	13/16"	88g	13/16"	100	160	8
1385355	7/8"	106g	7/8"	100	160	8
1385455	15/16"	117g	15/16"	100	120	6
1385555	1"	165g	1"	40	100	5
1385655	1.1/8"	200g	1.1/8"	100	80	4
1385755	1.3/16"	213g	1.3/16"	40	80	4
1385855	1.1/4"	220g	1.1/4"	100	80	4

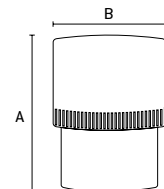

• Encaixe 1/2" | Fitting 1/2" | Encaje 1/2"
• Acabamento Niquelado e cromado fosco | Finish Nickel plated and chrome plated | Acabado Niquelado y cromado mate

Soquetes Estriado 1/2"

Striated Sockets 1/2" | Enchufes Estriado 1/2"



	SKU	KG	DIMENSÕES SIZE TAMAÑO (MM)		Quant. Min.	
			A	B		
1390855	8 mm	55g	35	8	200	10
1390955	9 mm	55g	35	9	200	10
1391055	10 mm	55g	35	10	200	10
1391155	11 mm	55g	35	11	200	10
1391255	12 mm	55g	35	12	200	10
1391355	13 mm	63g	40	13	200	10
1391455	14 mm	63g	40	14	200	10
1391555	15 mm	65g	40	15	200	10
1391655	16 mm	65g	40	16	200	10
1391755	17 mm	75g	40	17	160	8
1391855	18 mm	75g	40	18	160	8
1391955	19 mm	81g	40	19	160	8
1392055	20 mm	88g	40	20	160	8
1392155	21 mm	94g	40	21	160	8
1392255	22 mm	106g	40	22	160	8
1392355	23 mm	117g	40	23	120	6
1392455	24 mm	121g	40	24	120	6
1392655	26 mm	165g	40	26	100	5
1392755	27 mm	175g	40	27	100	5
1392855	28 mm	200g	45	28	80	4
1393055	30 mm	213g	45	30	80	4
1393255	32 mm	225g	45	32	80	4
<hr/>						
1394555	3/8"	55g	35	9,525	200	10
1394655	7/16"	55g	35	11,113	200	10
1394755	1/2"	55g	35	12,700	200	20
1394855	9/16"	63g	40	14,288	200	10
1394955	5/8"	65g	40	15,875	200	10
1395055	11/16"	75g	40	17,463	160	8
1395155	3/4"	75g	40	19,050	160	8
1395255	13/16"	88g	40	20,638	160	8
1395355	7/8"	106g	40	22,225	160	8
1395455	15/16"	117g	40	23,813	120	6
1395555	1"	165g	40	25,400	100	5
1395655	1.1/8"	200g	45	28,575	80	4
1395755	1.3/16"	213g	45	30,163	80	4
1395855	1.1/4"	225g	45	31,750	80	4

- Aço CrV Temperado | Stel CrV Temperate | Acero CrV templado
- Bi-Sextavado | Bi-hex | Bi-Hex
- Encaixe quadrado 1/2" | Square fitting 1/2" | Encaje cuadrado 1/2"
- Embalagem clip Plástico | Plastic Clip Packing | Embalaje de plástico

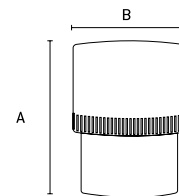

Linha de soquetes industriais

Industrial Socket Line | Línea de sockets industriales



	SKU	KG	DIMENSÕES SIZE TAMAÑO (MM)		Quant. Min.	
			A	B		
1322155	17 mm	275g	76	17	84	12
1322455	19 mm	276g	76	19	84	14
1322255	22 mm	308g	76	22	72	12

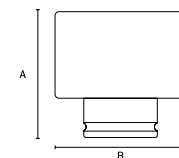

- Série Longa | Long Series | Serie Larga
- Aço CrMo de alta resistência Mecânica | CrMo Steel High Strength Mechanical | Acero CrMo de alta resistencia mecánica
- Tem alojamento para pino e anel de segurança | It has housing for pin and ring of security | Tiene alojamiento para pino y anillo de seguridad
- Para trabalhar com máquinas de impacto | To work with impact machines | Para trabajar con máquinas de impacto
- Encaixe quadrado 1/2" | Square fitting 1/2" | Encaje cuadrado 1/2"
- Embalagem: Caixa | Packing: Box | Embalaje: Caja

Linha de soquetes industriais

Industrial Socket Line | Línea de sockets industriales



Barcode	Size	Weight	DIMENSÕES SIZE TAMAÑO (MM)		Box	Quant. Min.
			A	B		
1320155	10 mm	75g	35	10	270	30
1320355	11 mm	76g	35	11	270	30
1320255	12 mm	76g	35	12	270	30
1320455	13 mm	77g	35	13	270	30
1320555	14 mm	82g	35	14	270	30
1320655	15 mm	119g	35	15	180	20
1320855	17 mm	125g	35	17	180	20
1320955	18 mm	124g	35	19	180	20
1321055	19 mm	124g	35	18	180	20
1321355	22 mm	135g	35	22	180	20

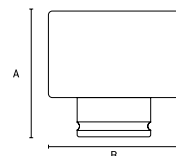

- Série Curta | Short Series | Serie Corta
- Aço CrMo de alta resistência Mecânica | CrMo Steel High Strength Mechanical | Acero CrMo de alta resistencia mecánica
- Tem alojamento para pino e anel de segurança | It has housing for pin and ring of security | Tiene alojamiento para pino y anillo de seguridad
- Para trabalhar com máquinas de impacto | To work with impact machines | Para trabajar con máquinas de impacto
- Encaixe quadrado 1/2" | Square fitting 1/2" | Encaje cuadrado 1/2"
- Embalagem: Caixa | Packing: Box | Embalaje: Caja

5

Linha de soquetes industriais

Industrial Socket Line | Línea de sockets industriales



Barcode	Size	Weight	DIMENSÕES SIZE TAMAÑO (MM)		Box	Quant. Min.
			A	B		
1325455	32 mm	460g	55	32	55	7
1325955	36 mm	495g	55	36	42	6
1325855	38 mm	510g	55	38	36	11
1325655	41 mm	620g	55	41	40	5

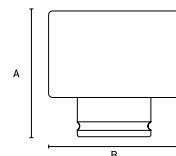

- Série Curta | Short Series | Serie Corta
- Aço CrMo de alta resistência Mecânica | CrMo Steel High Strength Mechanical | Acero CrMo de alta resistencia mecánica
- Tem alojamento para pino e anel de segurança | It has housing for pin and ring of security | Tiene alojamiento para pino y anillo de seguridad
- Para trabalhar com máquinas de impacto | To work with impact machines | Para trabajar con máquinas de impacto
- Encaixe quadrado 3/4" | Square fitting 3/4" | Encaje cuadrado 3/4"
- Embalagem: Caixa | Packing: Box | Embalaje: Caja

Jogo de Soquetes sextavados - 10 peças 1/2"

Socket Set Hexagonal - 10 parts | Juego de Sockets hexagonales - 10 piezas



10
peças
parts | piezas

Composição | Composition | composición:

- 10 soquetes: 10, 11, 12, 13, 14, 15, 17, 18, 19 e 22 mm.



1326155	1433g	15	1
---------	-------	----	---

CHAVE CORRESPONDENTE CORRESPONDING KEY CLAVE CORRESPONDENTE	KG	DIMENSÕES SIZE TAMAÑO (MM)	
		A	B
10 mm	75g	35	10
11 mm	76g	35	11
12 mm	76g	35	12
13 mm	77g	35	13
14 mm	82g	35	14
15 mm	119g	35	15
17 mm	125g	35	17
18 mm	124g	35	19
19 mm	124g	35	18
22 mm	135g	35	22

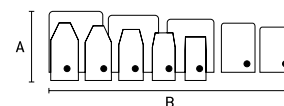

- Aço CrMo de alta resistência Mecânica | CrMo Steel High Strength Mechanical | Acero CrMo de alta resistencia mecánica
- Tem alojamento para pino e anel de segurança | It has housing for pin and ring of security | Tiene alojamiento para pino y anillo de seguridad
- Impacto | Sixth grade | Hexagonal
- Encaixe quadrado 1/2" | Square fitting 1/2" | Encaje cuadrado 1/2 "

Jogo de Soquetes sextavados - 11 peças 1/2"

Socket Set Hexagonal - 11 parts | Juego de Sockets hexagonales - 11 piezas



11
peças
parts | piezas

Composição | Composition | composición:

- 11 soquetes: 10, 11, 12, 13, 14, 15, 17, 18, 19, 22 e 24 mm.



1326255	3283g	6	1
---------	-------	---	---

CHAVE CORRESPONDENTE CORRESPONDING KEY CLAVE CORRESPONDENTE	KG	DIMENSÕES SIZE TAMAÑO (MM)	
		A	B
10 mm	150g	76	10
11 mm	152g	76	11
12 mm	152g	76	12
13 mm	154g	76	13
14 mm	164g	76	14
15 mm	238g	76	15
17 mm	250g	76	17
18 mm	248g	76	19
19 mm	248g	76	18
22 mm	270g	76	22
24 mm	308g	76	24

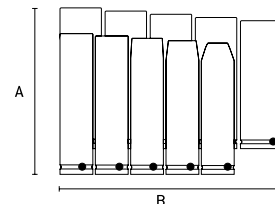

- Aço CrMo de alta resistência Mecânica | CrMo Steel High Strength Mechanical | Acero CrMo de alta resistencia mecánica
- Tem alojamento para pino e anel de segurança | It has housing for pin and ring of security | Tiene alojamiento para pino y anillo de seguridad
- Impacto | Sixth grade | Hexagonal
- Encaixe quadrado 1/2" | Square fitting 1/2" | Encaje cuadrado 1/2"

Soquetes Sextavado 1/2"

Sixth Sockets 1/2" | Enchufes Sextavado 1/2"



Código	mm	g	DIMENSÕES SIZE TAMAÑO (MM)		Quant. Min.
			A	B	
131109	10 mm	54g	35	10	400
131129	11 mm	56g	35	11	400
131119	12 mm	55g	35	12	400
131139	13 mm	58g	40	13	400
131149	14 mm	68g	40	14	400
131159	15 mm	58g	40	15	400
131169	16 mm	58g	40	16	400
131179	17 mm	67g	40	17	400
131189	18 mm	67g	40	18	300
131199	19 mm	70g	40	19	300
131209	20 mm	95g	40	20	200
131219	21 mm	90g	40	21	200
131229	22 mm	100g	40	22	200
131239	23 mm	110g	40	23	200
131249	24 mm	115g	40	24	200
131279	27 mm	160g	45	27	100
131309	30 mm	205g	45	30	120
131329	32 mm	230g	45	32	120

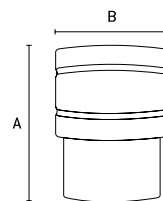

- Aço CrV Temperado | Stel Steel CrV Temperate | Acero CrV templado
- Acabamento Polido | Polished Finish | Acabado Pulido
- Encaixe quadrado 1/2" | Square fitting 1/2" | Encaje cuadrado 1/2"

Soquetes Estriado 1/2"

Striated Sockets 1/2" | Enchufes Estriado 1/2"



Código	mm	g	DIMENSÕES SIZE TAMAÑO (MM)		Quant. Min.
			A	B	
136769	8 mm	53g	35	8	400
136809	9 mm	55g	35	9	400
136789	10 mm	55g	35	10	400
136829	11 mm	58g	40	11	400
136849	12 mm	58g	40	12	400
136869	13 mm	58g	40	13	400
136889	14 mm	58g	40	14	400
136899	15 mm	60g	40	15	400
136909	17 mm	65g	40	17	300
136919	19 mm	70g	40	19	300
136929	22 mm	95g	40	22	200
136939	24 mm	110g	40	24	200
136959	27 mm	150g	45	30	120
136979	30 mm	200g	45	30	120
136989	32 mm	218g	45	32	120

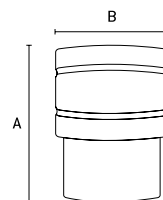

- Aço CrV Temperado | Stel Steel CrV Temperate | Acero CrV templado
- Bi-Sextavado | Bi-hex | Bi-Hex
- Acabamento Polido | Polished Finish | Acabado Pulido
- Encaixe quadrado 1/2" | Square fitting 1/2" | Encaje cuadrado 1/2"

5

Jogo de Soquetes 3/4"

Socket Set | Juego de Sockets



135369	soquetes 19 - 50	12.750g	DIMENSÕES SIZE TAMAÑO (MM)			2	1
			A	B	C		



Ajustável a várias cabeças de parafusos
Adjustable to multiple screw heads
Ajustable a varias cabezas de tornillo

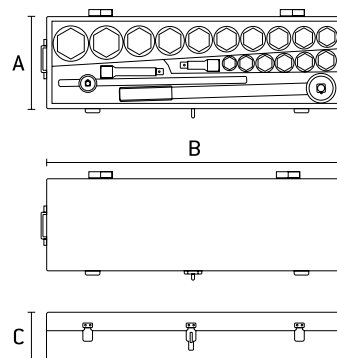

Composição | Composition | composición:

- 1 catraca de 3/4"
- 1 cabo de força T de 3/4"
- 1 extensão de 4" (100 mm)
- 1 extensão de 8" (200 mm)
- 16 soquetes: 19, 21, 22, 23, 24, 26, 27, 30, 32, 34, 36, 38, 41, 46, 48 e 50 mm.

- Aço CrV | Stel CrV | Acero CrV
- Caixa metálica | Metal case | Caja metálica
- Soquete Sextavado | Socket Sixth | Enchufe Hexagonal
- Encaixe 3/4" | Fitting 3/4 " | Encaje 3/4 "

Jogo de Soquetes - 26pçs - 3/4"

Socket Set - 26pcs - 3/4" | Juego de Sockets - 26pzs - 3/4"



135399	soquetes 21 - 62	19.500g	DIMENSÕES SIZE TAMAÑO (MM)			1	1
			A	B	C		

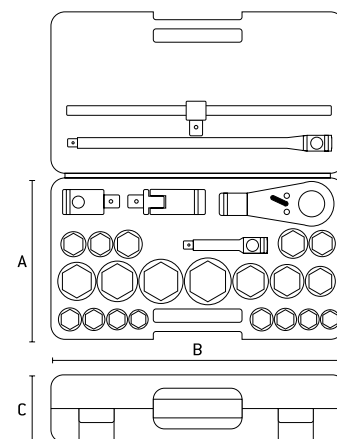

Composição | Composition | composición:

- 1 catraca de 3/4"
- 1 adaptador de 3/4" - 1"
- 1 cabo de força T de 3/4" (525 mm)
- 1 extensão reta de (525 mm)
- 1 extensão L de 8" (200 mm)
- 1 extensão de 8" (200 mm)
- 20 soquetes: 21, 22, 23, 24, 26, 27, 28, 29, 30, 31, 32, 34, 36, 38, 41, 46, 50, 55, 60 e 65 mm.

- Aço CrV | Stel CrV | Acero CrV
- Caixa plástica | Plastic box | Caja de plástico
- Soquete Sextavado | Socket Sixth | Enchufe Hexagonal
- Encaixe 3/4" | Fitting 3/4 " | Encaje 3/4 "

Jogo de Ferramentas/24pçs 1/2"

Tool Set - 24pcs | Juego de Herramientas-24pzs



135769



3500g

DIMENSÕES | SIZE | TAMAÑO (mm)

A B C

250 320 80



6



1



24
peças
parts / piezas



Catraca com 72 dentes

Ratchet with 72 teeth

Catraca con 72 dientes



CONTEÚDO DA EMBALAGEM

- 1 Chave catraca reversível 1/2" com cabo emborrachado / 72 dentes
- 1 Barra extensora de 10"
- 1 Barra extensora de 5"
- 1 Chave de vela (soquete sextavado longo) de 21mm
- 1 Chave de vela (soquete sextavado longo) de 16mm
- 1 Cabo T ajustável 1/2"
- 18 Soquetes estriados 1/2": [8, 9, 10, 11, 12, 13, 14, 15, 16, 17, 18, 19, 21, 22, 24, 27, 30 e 32mm]

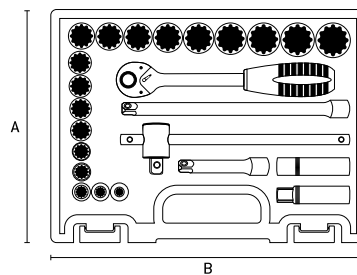

- Aço CrV de alta qualidade | High quality CrV steel | Acero CrV de alta calidad
- Bi-Sextavado | Bi-hex | Bi-Hex
- Caixa plástica | Plastic box | Caja de plástico
- Acabamento Fosco | Matte Finish | Acabado Mate
- Encaixe quadrado 1/2" | Square fitting 1/2" | Encaje cuadrado 1/2"

Jogo de Ferramentas/18pçs 1/2"

Tool Set-18pcs | Juego de Herramientas-18pzs



135779



4000g

DIMENSÕES | SIZE | TAMAÑO (mm)

A B C

250 320 80



6



1



18
peças
parts / piezas



Catraca com 72 dentes

Ratchet with 72 teeth

Catraca con 72 dientes



CONTEÚDO DA EMBALAGEM

- 1 Chave catraca reversível 1/2" com cabo emborrachado / 72 dentes
- 1 Barra extensora de 10"
- 1 Barra extensora de 5"
- 1 Cabo T ajustável 1/2"
- 14 Soquetes estriados 1/2": [10, 11, 12, 13, 14, 15, 16, 17, 19, 21, 24, 27, 30 e 32mm]

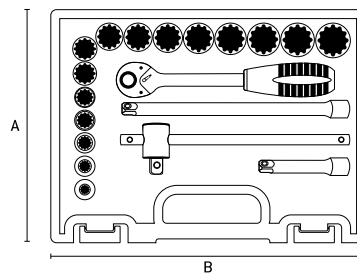

- Aço CrV de alta qualidade | High quality CrV steel | Acero CrV de alta calidad
- Bi-Sextavado | Bi-hex | Bi-Hex
- Caixa plástica | Plastic box | Caja de plástico
- Acabamento Fosco | Matte Finish | Acabado Mate
- Encaixe quadrado 1/2" | Square fitting 1/2" | Encaje cuadrado 1/2"

Jogo de Ferramentas/39pçs 1/2"

Tool Set-39pcs | Juego de Herramientas-39pzs



135789



5520g

DIMENSÕES | SIZE | TAMAÑO (mm)

A B C

290 380 100



4



1



39
peças
parts / piezas



Catraca com 72 dentes

Ratchet with 72 teeth

Catraca con 72 dientes



CONTEÚDO DA EMBALAGEM

- 1 Chave catraca reversível 1/2" com cabo emborrachado / 72 dentes
- 1 Barra extensora de 10"
- 1 Barra extensora de 3"
- 1 Barra extensora de 5"
- 1 Junta Universal de 1/2"
- 18 Soquetes estriados 1/2" em mm: [10, 11, 12, 13, 14, 15, 16, 17, 18, 19, 20, 21, 22, 23, 24, 27, 30 e 32mm]
- 14 Soquetes estriados 1/2 em polegadas: [1/2, 3/8, 7/16, 9/16, 5/8, 11/16, 3/4, 13/16, 7/8, 15/16, 1, 1-1/16, 1-1/8, 1-3/16 polegadas]
- 2 Soquetes longos sextavados: 5/8 e 13/16"

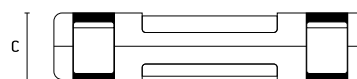
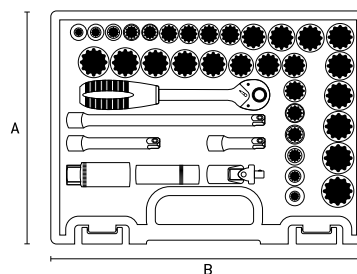

- Aço CrV de alta qualidade | High quality CrV steel | Acero CrV de alta calidad
- Bi-Sextavado | Bi-hex | Bi-Hex
- Caixa plástica | Plastic box | Caja de plástico
- Acabamento Fosco | Matte Finish | Acabado Mate
- Encaixe quadrado 1/2" | Square fitting 1/2" | Encaje cuadrado 1/2"

5

Jogo de Ferramentas/41 pçs

TOOL SET 41PCS | JUEGO DE HERRAMIENTAS 41PZS

135799	Maleta: 250x320x80mm	4700g	6	1



DETALHES DO PRODUTO

Material:
Aço cromo vanádio com acabamento cromado
Catraca com design ergonômico e 72 dentes
Encaixe de 1/2"
Acompanha maleta plástica

CONTEÚDO DA EMBALAGEM

- 1 Catraca reversível
- 1 Extensão 125mm
- 1 Junta universal
- 4 Soquetes estriados longos:
(14, 15, 17 e 19 mm)
- 13 Soquetes estriados:
(10, 11, 12, 13, 14, 15, 17, 19, 22, 24, 27, 30 e 32 mm)
- 1 Adaptador 1/2" F x 3/8"
- 1 Adaptador para bit 1/2" x 5/16"
- 8 Bits:
- 2 Pozidriv: PZ3 e PZ4
- 2 Phillips: PH3 e PH4
- 2 Fenda: 8 e 10 mm
- 2 Allen: 8 e 10 mm
- 1 Jogo de chaves allens com 9 peças e suporte:
(1.5, 2, 2.5, 3, 4, 5, 6, 8 e 10 mm)



STELS

1358099	6667g	Maleta: 380x280x85mm	3	1

Jogo de Ferramentas/94 pçs

TOOL SET 94PCS | JUEGO DE HERRAMIENTAS 94PZS



DETALHES DO PRODUTO

- Encaixe: 1/2" e 1/4"
- **Material:** Aço Cromo Vanádio
- Produtos de excelente qualidade, soquetes e chaves em Aço CR-V
- Soquetes 1/2" com boca estriada
- Catraca reversível com cabo emborrachado / 72 dente
- Maleta resistente

CONTEÚDO DA EMBALAGEM

- 1 Chave catraca reversível 1/2" com cabo emborrachado
- 1 Chave catraca reversível 1/4" com cabo emborrachado
- 1 Barra extensora 1/2 de 5"
- 1 Barra extensora 1/4 de 50mm
- 1 Barra extensora 1/4 de 100mm
- 1 Barra extensora flexível 1/4 de 150mm
- 1 Junta Universal de 1/2"
- 1 Junta Universal de 1/4"
- 1 Chave T de 1/2"
- 1 Chave T de 1/4"
- 1 Chave reta de 1/4"
- 18 Soquetes estriados:
(1/2" 10, 11, 12, 13, 14, 15, 16, 17, 18, 19, 20, 21, 22, 23, 24, 27, 30 e 32mm)
- 13 Soquetes estriados de 1/4":
(4, 4.5, 5, 5.5, 6, 7, 8, 9, 10, 11, 12, 14 e 14mm)
- 4 Soquetes longos multi-estriados 1/2: (14, 15, 17 e 19mm)
- 8 Soquetes longos multi-estriados 1/4:
(6, 7, 8, 9, 10, 11, 12 e 13mm)
- 33 pontas diversas, fenda, phillips, torx e allen
- 1 adaptador para bits de 1/2"
- 2 Chaves de vela (soquetes sextavados) de 16 e 21mm
- 3 Chaves Allen: 1.5, 2, 2.5mm



Jogo de Ferramentas/29 pçs 1/4"

TOOL SET 29PCS | JUEGO DE HERRAMIENTAS 29PZS

antigo	novo			
14100	1410055	Maleta: 160x270x80mm	20	1



DETALHES DO PRODUTO

- Encaixe 1/4
- Produtos de excelente qualidade, soquetes e chaves em Aço CR-V
- Soquetes 1/4 com boca sextavada
- Catraca reversível 1/4 com cabo emborrachado / 72 dente
- Maleta resistente

CONTEÚDO DA EMBALAGEM

- 1 Chave catraca reversível 1/4 com cabo emborrachado
- 1 Barra extensora 2 polegadas
- 1 Junta universal de 1/4
- 1 Cabo T ajustável 1/4
- 1 Chave manual encaixe quadrado de 1/4
- 12 Soquetes sextavados encaixe 1/4 medidas: [4, 4.5, 5, 5.5, 6, 7, 8, 9, 10, 11, 12, 13mm]
- 12 Soquetes bits, sendo:
 - 2 bits phillips: PH1, PH2
 - 2 bits pozidriv: PZ1, PZ2
 - 3 bits fenda: SL4, SL5.5, SL7
 - 5 bits tipo allen: H3, H4, H5, H6, H8



STELS

antigo	novo			
14101	1410155	Maleta - 160X270mm	15	1

Jogo de Ferramentas/57 pçs 1/4"

TOOL SET 57PCS | JUEGO DE HERRAMIENTAS 57PZS



DETALHES DO PRODUTO

- Encaixe 1/4
- Produtos de excelente qualidade, soquetes e chaves em Aço CRV
- Soquetes 1/4 com boca sextavada
 - Catraca reversível 1/4 com cabo emborrachado / 72 dente
 - Maleta resistente

CONTEÚDO DA EMBALAGEM

- 1 Chave catraca reversível 1/4 com cabo emborrachado
- 1 Barra extensora 2 polegadas
- 1 Barra extensora 4 polegadas
- 1 Junta universal de 1/4
- 1 Chave manual encaixe quadrado de 1/4
- 4 Chaves hexagonais tipo allen, medidas: [1.5, 2, 2.5, 3mm]
- 4 Soquetes sextavados longos, medidas: [6, 7, 8, 10]
- 13 Soquetes sextavados encaixe 1/4, medidas: [4, 4.5, 5, 5.5, 6, 7, 8, 9, 10, 11, 12, 13, 14mm]
- 06 Soquetes torx fêmea, medidas: [E4, E5, E6, E7, E8, E10]
- 24 Soquetes bits, sendo:
 - 3 bits phillips: PH1, PH2, PH3
 - 3 bits pozidriv: PZ1, PZ2, Pz3
 - 3 bits fenda: SL4, SL5.5, SL6.5
 - 7 bits tipo allen: H3, H4, H5, H6, H8
- 8 bits torx (sem furo guia): T8, T10, T15, T20, T25, T27, T30, T40



Jogo de Soquetes/curto

Socket Set /short | Juego de Sockets /corto



Código	Descrição	DIMENSÕES SIZE TAMAÑO (MM)		Quant. Min.	
		A	B		
135579	ENCAIXE 1/2" 10 - 22mm	100	390	30	1
135589	ENCAIXE 3/8" 8 - 19mm	965	330	50	10
135599	ENCAIXE 1/4" 4 - 13mm	70	245	60	10



10 peças
parts | piezas

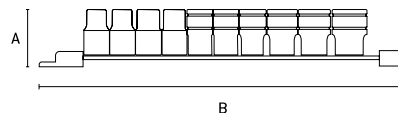

- Aço CrV | CrV steel | Acero CrV
- Sextavado | Sixth grade | Hexagonal
- Acabamento Polido | Polished Finish | Acabado Pulido

- Composição | Composition | composición:
- 135579: 10 soquetes 1/2": 10, 11, 12, 13, 14, 15, 17, 18, 19, 22 mm.
 - 135589: 10 soquetes 3/8: 8,,10, 11, 12, 13, 14, 15, 17, 18, 19 mm.
 - 135599: 10 soquetes 1/4: 4, 5, 6, 7, 8, 9, 10, 11, 12, 13 mm.

Jogo de Soquetes/curto

Socket Set /short | Juego de Sockets /corto



Código	Descrição	DIMENSÕES SIZE TAMAÑO (MM)		Quant. Min.	
		A	B		
135949	ENCAIXE 1/4" 4 - 13mm	70	245	60	10
135969	ENCAIXE 1/2" 10 - 24mm	100	390	30	10



10 peças
parts | piezas

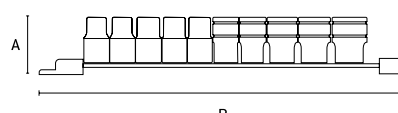

- Aço CrV | CrV steel | Acero CrV
- Bi-Sextavado | Bi-hex | Bi-Hex
- Estriado | Striated | Estriado
- Acabamento Polido | Polished Finish | Acabado Pulido

- Composição | Composition | composición:
- 135949: 10 soquetes 1/4: 4, 5, 6, 7, 8, 9, 10, 11, 12, 13 mm.
 - 135969: 10 soquetes 1/2": 10, 11, 12, 13, 14, 16, 17, 19, 22 e 24 mm.

Jogo de Soquetes/longo

Sockets / Long Set | Juego de Sockets / Largo



Código	Descrição	DIMENSÕES SIZE TAMAÑO (MM)		Quant. Min.	
		A	B		
135909	ENCAIXE 1/2" 10 - 22mm	120	355	20	5
135919	ENCAIXE 3/8" 8 - 19mm	120	355	30	5



10 peças
parts | piezas

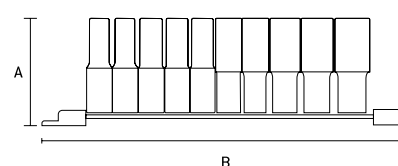

- Aço CrV | CrV steel | Acero CrV
- Sextavado | Sixth grade | Hexagonal
- Longo | Long | Largo
- Acabamento Polido | Polished Finish | Acabado Pulido

- Composição | Composition | composición:
- 135909: 10 soquetes 1/2": 10, 11, 12, 13, 14, 15, 17, 18, 19, 22 mm
 - 135919: 10 soquetes 3/8: 8,,10, 11, 12, 13, 14, 15, 17, 18, 19 mm.

Jogo de Soquetes SPLINE 1/2"

Socket Set SPLINE | Juego de Sockets SPLINE



Código	Descrição	DIMENSÕES SIZE TAMAÑO (MM)		Quant. Min.	
		A	B		
135979	ENCAIXE 1/2" 10 - 22	100	10 - 22mm	30	10



10 peças
parts | piezas

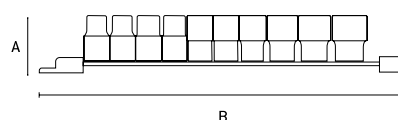

- Aço CrV | CrV steel | Acero CrV
- Spline | Spline | Spline
- Curtos | Short | Corto
- Acabamento Polido | Polished Finish | Acabado Pulido

- Composição | Composition | composición:
- 135979: 10 soquetes 1/2": 10, 11, 12, 13, 14, 15, 17, 18, 19, 22 mm

Jogo de Soquetes/curto

Socket Set /short | Juego de Sockets /corto



- Aço CrV | CrV steel | Acero CrV
- Sextavado | Sixth grade | Hexagonal
- Curtos | Short | Corto
- Acabamento Polido | Polished Finish | Acabado Pulido

Código	Encaixe	DIMENSÕES SIZE TAMAÑO (MM)		Quant. Min.
		A	B	
1355755	Encaixe 1/2" 10 - 22mm	100	390	30 1
1355855	Encaixe 3/8" 8 - 19mm	965	330	50 10
1355955	Encaixe 1/4" 4 - 13mm	70	245	60 10

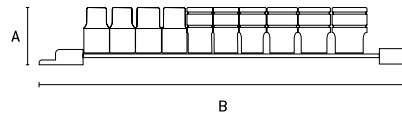

Composição | Composition | composición:
 • 1355755: 10 soquetes 1/2": 10, 11, 12, 13, 14, 15, 17, 18, 19, 22 mm.
 • 1355855: 10 soquetes 3/8": 8,,10, 11, 12, 13, 14, 15, 17, 18, 19 mm.
 • 1355955: 10 soquetes 1/4": 4, 5, 6, 7, 8, 9, 10, 11, 12, 13 mm.

Jogo de Soquetes/curto

Socket Set /short | Juego de Sockets /corto



- Aço CrV | CrV steel | Acero CrV
- Bi-Sextavado | Bi-hex | Bi-Hex
- Estriado | Striated | Estriado
- Curtos | Short | Corto
- Acabamento Polido | Polished Finish | Acabado Pulido

Código	Encaixe	DIMENSÕES SIZE TAMAÑO (MM)		Quant. Min.
		A	B	
1359455	Encaixe 1/4" 4 - 13mm	70	245	60 10
1359655	Encaixe 1/2" 10 - 24mm	100	390	30 10



Composição | Composition | composición:
 • 1359455: 10 soquetes 1/4": 4, 5, 6, 7, 8, 9, 10, 11, 12, 13 mm.
 • 1359655: 10 soquetes 1/2": 10, 11, 12, 13, 14, 16, 17, 19, 22 e 24 mm.

Jogo de Soquetes/longo

Sockets / Long Set | Juego de Sockets / Largo



- Aço CrV | CrV steel | Acero CrV
- Sextavado | Sixth grade | Hexagonal
- Longo | Long | Largo
- Acabamento Polido | Polished Finish | Acabado Pulido

Código	Encaixe	DIMENSÕES SIZE TAMAÑO (MM)		Quant. Min.
		A	B	
1359055	Encaixe 1/2" 10 - 22mm	120	355	20 5
1359155	Encaixe 3/8" 8 - 19mm	120	355	30 5

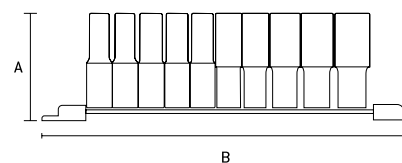

Composição | Composition | composición:
 • 1359055: 10 soquetes 1/2": 10, 11, 12, 13, 14, 15, 17, 18, 19, 22 mm
 • 1359155: 10 soquetes 3/8": 8,,10, 11, 12, 13, 14, 15, 17, 18, 19 mm.

Jogo de Soquetes SPLINE

Socket Set SPLINE | Juego de Sockets SPLINE



- Aço CrV | CrV steel | Acero CrV
- Spline | Spline | Spline
- Curtos | Short | Corto
- Acabamento Polido | Polished Finish | Acabado Pulido

Código	Encaixe	DIMENSÕES SIZE TAMAÑO (MM)		Quant. Min.
		A	B	
1359755	Encaixe 1/2" 10 - 22	100	10 - 22mm	30 10

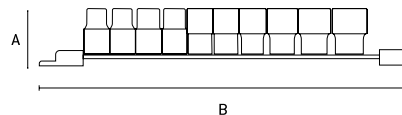

Composição | Composition | composición:
 • 1359755: 10 soquetes 1/2": 10, 11, 12, 13, 14, 15, 17, 18, 19, 22 mm

5

Extensão Flexível

Flexible Extension | Extensión Flexible



	ESTELS	KG	DIMENSÕES SIZE TAMAÑO (MM)		Quant. Min.	
			A	B		
11367	1136756	76g	13	260	50	10
11369	1136956	96g	13	278	50	10

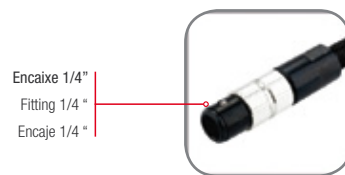
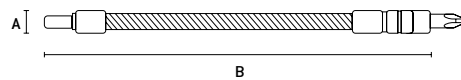

- Adaptador Magnético | Magnetic Adapter | Adaptador magnético

Extensões

Extensions | Extensiones



antigo	novo	KG	DIMENSÕES SIZE TAMAÑO (MM)			Quant. Min.	
			A	B	C		
13902	1390255	24g	6	50	12	900	60
13903	1390355	67g	6	150	12	300	20
13904	1390455	84g	10	75	18	240	40
13905	1390555	150g	10	150	18	150	25
13906	1390655	202g	13	125	23	120	30
13908	1390856	405g	13	250	22	60	10

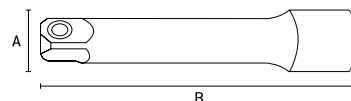

- Aço CrV de alta qualidade | High quality CrV steel | Acero CrV de alta calidad
- Acabamento Fosco | Matte Finish | Acabado Mate

Extensões

Extensions | Extensiones



	KG	DIMENSÕES SIZE TAMAÑO (MM)		Quant. Min.	
		A	B		
139729 125mm encaixe 1/2"	205g	13	125	120	20
139739 250mm encaixe 1/2"	400g	13	250	60	10

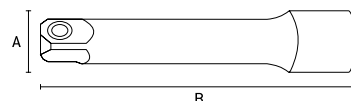

- Aço CrV | CrV steel | Acero CrV
- Acabamento Polido | Polished Finish | Acabado Pulido

Extensões abaulada

Extensions bulging | Extensiones abombadas



139709	1/4"	48g	DIMENSÕES SIZE TAMAÑO (MM)		500	10
			A	B		
139719	3/8"	78g	10	75	300	10
139799	1/2"	230g	13	125	100	10

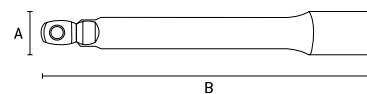

- Ponta abaulada | Bullet point | Extremidad abombada
- Articula em ângulo de 25° | Articulates at an angle of 25° | Articula en ángulo de 25°

- Aço CrV | CrV steel | Acero CrV
- Acabamento Polido | Polished Finish | Acabado Pulido

Extensão Flexível | 1/4"

Flexible Extension-1/4" | Extensión Flexible-1/4"



13909	1390955	150mm	1/4"	62g	DIMENSÕES SIZE TAMAÑO (MM)		400	20
					A	B		
					12	150		



- Aço CrV | Stel CrV | Acero CrV
- Para soquetes manuais com encaixe quadrado 1/4" | For manual sockets with square fitting 1/4" | Para sockets manuales con ranura cuadrada 1/4"
- Acabamento Polido | Polished Finish | Acabado Pulido
- Flexível | Flexible | Flexible

Cabo de Força Articulado 1/2" quadrado

Articulated Power Cable 1/2" square | Cable de Fuerza Articulado 1/2" cuadradas



140669	380mm, encaixe 1/2"	750g	DIMENSÕES SIZE TAMAÑO (MM)		28	7
			A	B		
			13	380		

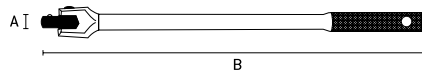

- A articulação em ângulo de (180 graus) | The angled articulation of (180 degrees) | La articulación en ángulo de (180 grados)

- Aço CrV | CrV steel | Acero CrV
- Acabamento Polido | Polished Finish | Acabado Pulido



Junta universal

Universal joint | Junta universal

CrV
Alta
Qualidade



Barcode	Size	KG	DIMENSÕES SIZE TAMAÑO (MM)		Box	Quant. Min.
			A	B		
139939	1/4"	33g	12	40	500	10
139949	3/8"	67g	20	54	300	60
139959	1/2"	155g	23	72	200	25

VENDA POR

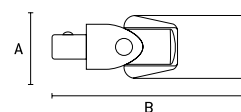

- Aço CrV | CrV steel | Acero CrV
- Acabamento Polido | Polished Finish | Acabado Pulido

Adaptador

Adapter | Adaptador

CrV
Alta
Qualidade

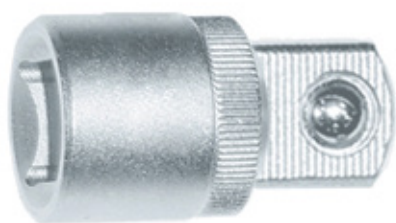

VENDA POR

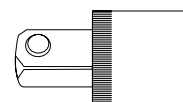

Barcode	Size	KG	Box	Quant. Min.
1390155	1/4" - 3/8"	21g	200	50
1391156	3/8" - 1/2"	55g	200	30

Chave suporte para soquetes

Socket wrench holder | Llave de soporte para sockets

CrV
Alta
Qualidade



Barcode	Size	KG	DIMENSÕES SIZE TAMAÑO (MM)		Box	Quant. Min.
			A	B		
14012	1/4" (150)	94g	6,350	150	240	30

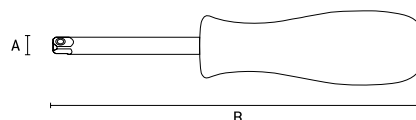

VENDA POR

- Haste em Aço CrV | CrV Steel Rod | Vástago en Acero CrV
- Cabo ergonômico | Ergonomic cable | Mango ergonómico
- Encaixe quadrado | Fitting square | Encaje cuadrado
- Para soquetes | For sockets | Para los sockets

Chave suporte para soquetes

Socket wrench holder | Llave de soporte para sockets

CrV
Alta
Qualidade



Barcode	Size	KG	DIMENSÕES SIZE TAMAÑO (MM)		Box	Quant. Min.
			A	B		
139209	1/4" (150)	95g	6,350	150	200	10

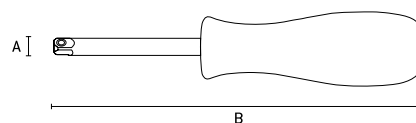

VENDA POR

- Encaixe quadrado | Fitting square | Encaje cuadrado

Cabo de força "T"

Power cable "T" | Cable de fuerza "T"

CrV
Alta
Qualidade



Código	Descrição	Peso (KG)	DIMENSÕES SIZE TAMAÑO (MM)			Quant. Min.
			A	B	C	
139869	115mm, encaixe 1/4"	48g	25	115	500	100
139879	200mm, encaixe 3/8"	181g	32	200	120	20
139889	250mm, encaixe 1/2"	371g	42	250	48	12

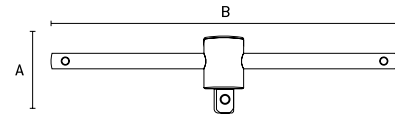

- Aço CrV | CrV steel | Acero CrV
- Acabamento Fosco | Matte Finish | Acabado Mate

Cabo de força "T"

Power cable "T" | Cable de fuerza "T"

CrV
Alta
Qualidade



Código	Descrição	Peso (KG)	DIMENSÕES SIZE TAMAÑO (MM)			Quant. Min.
			A	B	C	
14011	115mm, encaixe 1/4"	47g	14	115	400	100

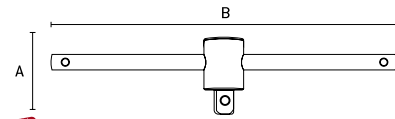

- Aço CrV de alta qualidade | High quality CrV steel | Acero CrV de alta calidad
- Acabamento Fosco | Matte Finish | Acabado Mate

Chave de catraca

Ratchet wrench | Llave de trinquete

CrV
Alta
Qualidade



Código	Descrição	Peso (KG)	DIMENSÕES SIZE TAMAÑO (MM)			Quant. Min.	
			A	B	C		
140205	Encaixe 1/4"	136g	6,350	125	30	100	20
140405	Encaixe 3/8"	223g	9,525	185	32	50	10
140605	Encaixe 1/2"	270g	12,700	230	35	50	10

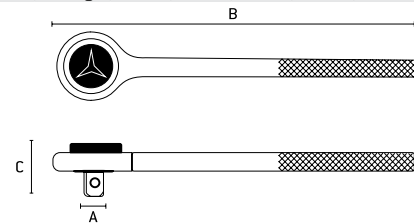

- Sistema reversível com pino | Reversible system with pin | Sistema reversible con pin
- Acabamento Cromado | Chrome Finish | Acabado Cromado

Chave de catraca

Ratchet wrench | Llave de trinquete

CrV
Alta
Qualidade



Código	Descrição	Peso (KG)	DIMENSÕES SIZE TAMAÑO (MM)			Quant. Min.	
			A	B	C		
140139	Encaixe 3/8"	272g	9,525	200	32	50	5*

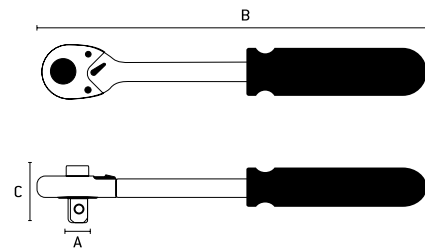

- Aço CrV | CrV steel | Acero CrV
- Sistema reversível com pino | Reversible system with pin | Sistema reversible con pin
- Acabamento Cromado | Chrome Finish | Acabado Cromado

Chave de catraca

Ratchet wrench | Llave de trinquete

CrV
Alta
Qualidade



Código	Descrição	Peso (KG)	DIMENSÕES SIZE TAMAÑO (MM)			Quant. Min.	
			A	B	C		
1401055	Encaixe 1/4"	170g	6,350	150	30	100	5
1401355	Encaixe 3/8"	250g	9,525	200	35	50	5
140159	Encaixe 1/2"	300g	12,700	250	40	25	1

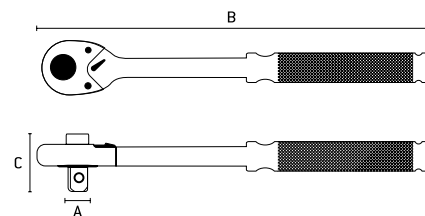

- Aço CrV | CrV steel | Acero CrV
- Sistema reversível com pino | Reversible system with pin | Sistema reversible con pin
- Acabamento Cromado | Chrome Finish | Acabado Cromado

5

Chave de catraca

Ratchet wrench | Llave de trinquete



antigo	novo	SKU	KG	DIMENSÕES SIZE TAMAÑO (MM)			Quant. Min.	
				A	B	C		
14025	1402555	Encaixe 1/4"	150g	6,350	150	30	100	20
14026	1402655	Encaixe 3/8"	250g	9,525	200	35	50	10
14127	1412755	Encaixe 1/2"	300g	12,700	250	40	50	10

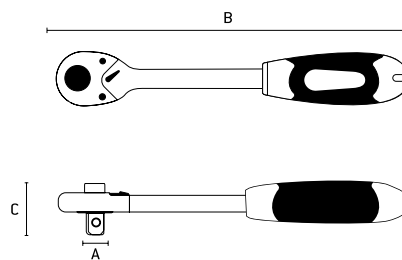

- Sistema reversível com pino rápido | Reversible system with fast pin | Sistema reversible con pin rápido
- Catraca com 72 Dentes | Ratchet with 72 Teeth | Catraca con 72 dientes
- Cabo de dois componentes | Two-component cable | Mango de dos componentes

Chave de catraca Teflonada

Teflon Ratchet wrench | Llave de trinquete Teflón



antigo	novo	SKU	KG	DIMENSÕES SIZE TAMAÑO (MM)			Quant. Min.	
				A	B	C		
14028	1402855	Encaixe 1/4"	150g	6,350	150	30	100	10
14029	1402955	Encaixe 3/8"	250g	9,525	200	35	50	10
14030	1403055	Encaixe 1/2"	300g	12,700	250	40	50	5

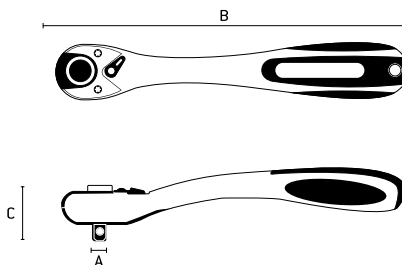

- Sistema reversível com pino rápido | Reversible system with fast pin | Sistema reversible con pin rápido
- Catraca com 72 Dentes | Ratchet with 72 Teeth | Catraca con 72 dientes
- Teflonada | Teflon | Teflón

Chave de catraca Teflonada

Teflon Ratchet wrench | Llave de trinquete Teflón



SKU	SKU	KG	DIMENSÕES SIZE TAMAÑO (MM)			Quant. Min.	
			A	B	C		
14082	Encaixe 1/2"	300g	12,700	250	40	24	6*
14084	Encaixe 3/8"	250g	9,525	200	35	48	12*
14086	Encaixe 1/4"	150g	6,350	150	30	100	25*



Sistema reversível com pino rápido
Reversible system with fast pin
Sistema reversible con pin rápido

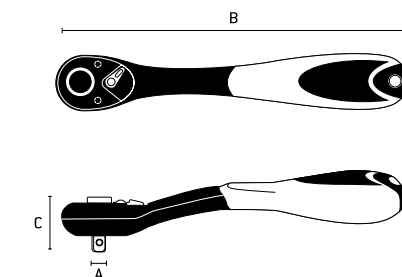

- Catraca com 72 Dentes | Ratchet with 72 Teeth | Catraca con 72 dientes
- Teflonada | Teflon | Teflón

Jogo de Chave de catraca 11 peças

11 Piece Ratchet Wrench Set | Juego de llave de trinquete 11 piezas



SKU	SKU	KG	DIMENSÕES SIZE TAMAÑO (MM)		Quant. Min.	
			A	B		
1412755	1/2" Soquetes (10-22mm)	1253g	100	320	15	5

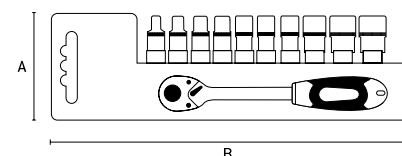

Composição:

- 1 Chave de catraca de 1/2"
- 10 soquete sextavado: 10 | 12 | 13 | 14 | 15 | 16 | 17 | 19 | 21 | 22mm

- Catraca com 72 Dentes | Ratchet with 72 Teeth | Catraca con 72 dientes
- Soquetes (10 - 22mm) | Sockets (10 - 22mm) | Enchufe (10 - 22mm)

Torquímetro

Torque meter | Llave dinamométrica



	Barcode	Description	DIMENSÕES SIZE TAMAÑO (MM)		Box	Quant. Min.
			A	B		
141609		42 - 210 n.m (21 kg)	75	485	15	1
141629		70 - 350 n.m (35 kg)	80	658	8	1

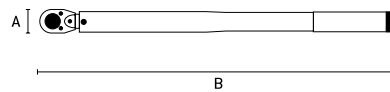

- Encaixe de 1/2" | 1/2 "fitting | Encaje de 1/2 "
- Divisão de escala: 0,35 Nm | Range Division: 35 Nm | División de escala: 0,35 Nm
- Ajuste de torque com trava (cabo) | Torque adjustment with lock (cable) | Ajuste de torsión con traba (cable)
- O torquímetro permite limitar com precisão a força aplicada para apertar parafusos | The torque wrench allows you to precisely limit the force applied to tightening screws | El torquímetro permite limitar con precisión la fuerza aplicada para apretar tornillos
- É fabricado em aço cromo Vanádio com catraca reversa | It is made of chrome Vanadium steel with reverse ratchet | Es fabricado en acero cromo Vanadio con catraca reversa

Torquímetro eletrônico

Electronic torque wrench | Torquímetro electrónico



	Barcode	Description	DIMENSÕES SIZE TAMAÑO (mm)		Box	Quant. Min.
			A	B		
14164		40 a 200 h.m (4 a 20 kgh.m)	114	247	24	6



- Com Adaptador 1/2" | With Adapter 1/2" | Con Adaptador 1/2"

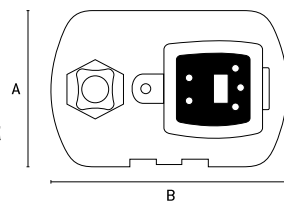

• CAPTURE O COD. QR PARA VER O VÍDEO DE EXPLICAÇÃO TÉCNICA
CAPTURE THE CODE. QR TO VIEW THE VIDEO OF TECHNICAL EXPLANATION

CAPTURE EL CÓDIGO QR PARA VER EL VIDEO DE EXPLICACION TÉCNICA



- **Chave torque eletrônico**
- **Indicado para apertar juntas roscadas com torque de aperto controlada 40-200 Hm**
- **1 adaptador quadrado de aço cromo-vanádio (CrV) 1/2"**
- **Visor de cristal líquido localizado no lado frontal da ferramenta, bem como a presença de nível aperto faixa de alarme de luz e som em tempo real.**
- **Saída de dados para o mostrador fornecida nas seguintes unidades de medição: kg / cm kg / m, lbs lb / pol. / ft, Nm.**
- **Bateria da chave é do tipo lítio CR2032 com vida útil de 55 horas.**
- **Embalagem: Caixa plástica e capa protetora chave**

- Chave torque eletrônico
- Indicado para apertar juntas roscadas com torque de aperto controlada 40-200 Hm
- 1 adaptador quadrado de aço cromo-vanádio (CrV) 1/2"
- Visor de cristal líquido localizado no lado frontal da ferramenta, bem como a presença de nível aperto faixa de alarme de luz e som em tempo real.
- Saída de dados para o mostrador fornecida nas seguintes unidades de medição: kg / cm kg / m, lbs lb / pol. / ft, Nm.
- Bateria da chave é do tipo lítio CR2032 com vida útil de 55 horas.
- Embalagem: Caixa plástica e capa protetora chave

- Llave de giro electrónico
- Indicado para apertar juntas roscas con torque de apriete controlado 40-200 Hm
- 1 adaptador cuadrado de acero cromo-vanadio (CrV) 1/2 "
- Visor de cristal líquido situado en el lado frontal de la herramienta, así como la presencia de nivel de banda de alarma de luz y sonido en tiempo real.
- Salida de datos para la pantalla suministrada en las siguientes unidades de medida: kg / cm kg / m, lbs lb / pulg. / ft, Nm.
- La batería de la llave es del tipo litio CR2032 con una vida útil de 55 horas.
- Embalaje: Caja plástica y tapa protectora clave

5

Chave de Roda Tipo L

Type L Wheel Wrench | Llave de Rueda Tipo L



Barcode	SKU	KG	DIMENSÕES SIZE TAMAÑO (MM)		Box	Quant. Min.
			A	B		
1421055	17mm	575g	115	250	40	10
1422455	19mm	625g	115	250	40	10

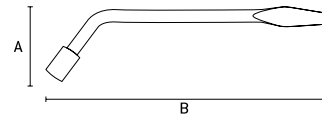

- Com espátula | With spatula | Con espátula

Chave de Roda em Cruz

Cross Wheel Wrench | Llave de Rueda en Cruz



Barcode	SKU	KG	DIMENSÕES SIZE TAMAÑO (MM)		Box	Quant. Min.
			A	B		
1424555	Encaixe 1/2"	1892g	492		12	1

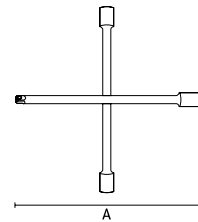

Chave de Roda

Wheel Wrench | Llave de Rueda



Barcode	SKU	KG	DIMENSÕES SIZE TAMAÑO (MM)		Box	Quant. Min.
			A	B		
142379	Encaixe 1/2"; 17x19 mm	1055g	137	427	20	5

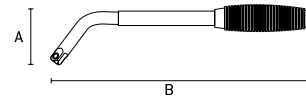

- Com Soquete 17x19mm | With Socket 17x19mm | Con Socket 17x19mm

Chave de Roda

Wheel Wrench | Llave de Rueda



Barcode	SKU	KG	DIMENSÕES SIZE TAMAÑO (MM)		Box	Quant. Min.
			A	B		
14250	Encaixe 1/2" 17x18x21mm	1444g	467		16	8

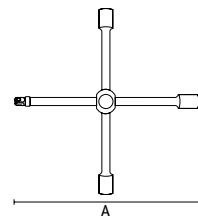

- Aço CrV Temperado | Tempered CrV Steel | Acero CrV Templado

Chave de Biela

Connecting rod wrench | Llave de Biela



Barcode	SKU	KG	DIMENSÕES SIZE TAMAÑO (MM)		Box	Quant. Min.
			A	B		
1420155	3/8"	250g	85	230	100	10
1420255	7/16"	270g	85	230	100	10
1420355	1/2"	320g	85	240	80	8
1420455	9/16"	420g	95	240	80	8
1420555	5/8"	420g	95	240	50	5
1420655	11/16"	470g	100	260	50	5
1420755	3/4"	530g	100	260	40	4
1430155	8mm	220g	85	230	100	10
1430255	9mm	230g	85	230	100	10
1430355	10mm	250g	85	230	100	10
1430455	11mm	270g	85	230	60	6
1430555	12mm	270g	95	240	200	8
1430655	13mm	320g	95	240	80	8
1430755	14mm	320g	95	240	80	8
1430855	15mm	420g	95	240	50	5
1430955	16mm	420g	95	240	50	5
1431055	17mm	440g	100	260	50	5
1431155	18mm	470g	100	260	40	4
1431255	19mm	530g	100	260	40	4

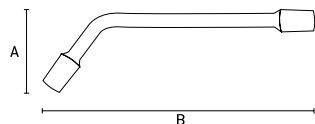

- Aço CrV | Steel CrV | Acero CrV
- Tipo L | Type L | Tipo L
- Niquelado | Nickel plated | Níquel

Chave de Roda Montável

Mountable Wheel Wrench | Llave de Rueda de montaje



antigo	novo		KG	DIMENSÕES SIZE TAMAÑO (MM)				Quant. Min.
				A	B	C		
14270	1427055	17 X 19 X 21 X 23mm	1892g	81	492	65	12	1

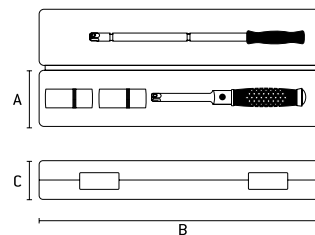

- Chave montável com soquetes | Mountable switch with sockets | Llave de montaje con sockets

Chave Fixa

Fixed key | Clave fija

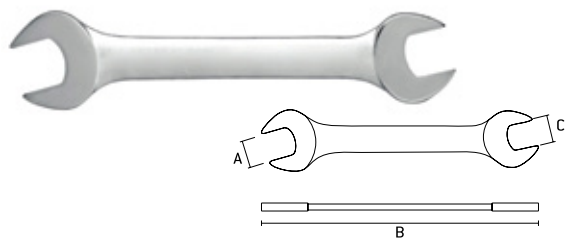

			KG	DIMENSÕES SIZE TAMAÑO (MM)				Quant. Min.
				A	B	C		
1440155	6 X 7 mm	30g	20	120	7	1000	50	
1440255	8 X 9 mm	40g	20	130	9	600	50	
1440355	10 X 11 mm	60g	70	280	11	400	50	
1440455	12 X 13 mm	80g	30	170	13	300	25	
1440555	14 X 15 mm	100g	30	180	15	250	25	
1440655	16 X 17 mm	140g	35	200	17	100	25	
1440755	18 X 19 mm	190g	40	220	19	100	10	
1440855	20 X 22 mm	230g	45	230	22	100	10	
1440955	21 X 23 mm	260g	50	240	23	100	10	
1441055	24 X 26 mm	350g	50	260	26	60	5	
1441155	25 X 28 mm	430g	60	270	28	50	5	
1441255	27 X 32 mm	580g	55	290	32	50	5	
1441355	30 X 32 mm	550g	65	280	32	40	5	

- Aço CrV Temperado | Tempered CrV Steel | Acero CrV Templado
- Acabamento Fosco | Matte Finish | Acabado Mate

Chave Fixa

Fixed key | Clave fija



			KG	DIMENSÕES SIZE TAMAÑO (MM)				Quant. Min.
				A	B	C		
144305	6 X 7 mm	18g	6	95	7	600	10*	
144365	8 X 10 mm	27g	8	110	10	500	10*	
144655	20 X 22 mm	152g	20	193	22	150	5*	
144715	22 X 24 mm	204g	22	210	24	100	5*	
144775	24 X 27 mm	246g	24	220	27	100	5*	

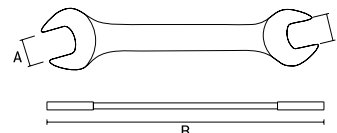

- Acabamento Cromado | Chrome Finish | Acabado Cromado
- Aço carbono | Carbon steel | Acero carbono

Chave Estrela

Star key | Clave estrella



			KG	DIMENSÕES SIZE TAMAÑO (MM)				Quant. Min.
				A	B	C		
147615	17 X 19 mm	231g	17	265	19	100	5*	



- Acabamento Cromado | Chrome Finish | Acabado Cromado

Chave Combinada

Combined key | Llave Combinada



			KG	DIMENSÕES SIZE TAMAÑO (MM)			Quant. Min.
				A	B		
150355	8 mm	27g	8	120	500	10*	
150425	15 mm	90g	15	190	200	10*	
150445	17 mm	130g	17	210	100	10*	
150465	19 mm	135g	19	230	100	10*	



- Acabamento Cromado | Chrome Finish | Acabado Cromado
- Galvanizada | Galvanized | Galvanizado

5

Chave estrela c/ catraca

Fixed wrench with ratchet | Llave fija con tornillo



Barcode	Size	Weight (KG)	DIMENSÕES SIZE TAMAÑO (MM)			Pack	Quant. Min.
			A	B	C		
145039	12 X 13 mm	138g	12	235	13	200	10
145049	14 X 15 mm	190g	14	246	15	150	10
145059	16 X 17 mm	242g	16	250	17	100	5
145079	18 X 19 mm	336g	18	235	19	50	5

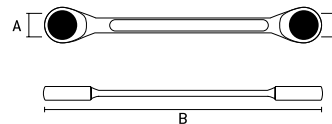

- Cabeça com catraca | Ratchet head | Cabeza con trinquete
- Acabamento Cromado | Chrome Finish | Acabado Cromado
- Norma DIN 3113 | Standard DIN 3113 | Norma DIN 3113

Chave Combinada

Combined key | Llave Combinada



Barcode	Size	Weight (KG)	DIMENSÕES SIZE TAMAÑO (MM)		Pack	Quant. Min.
			A	B		
1460155	6 mm	32g	6	160	300	75
1460255	7 mm	39g	7	170	300	75
1460355	8 mm	45g	8	170	240	60
1460455	9 mm	49g	9	180	240	60
1460555	10 mm	61g	10	190	200	25
1460655	11 mm	69g	11	200	200	25
1460755	12 mm	73g	12	200	200	25
1460855	13 mm	89g	13	220	200	25
1460955	14 mm	108g	14	220	200	25
1461055	15 mm	124g	15	220	200	25
1461155	16 mm	139g	16	240	120	30
1461255	17 mm	151g	17	240	120	30
1461355	18 mm	161g	18	240	120	30
1461455	19 mm	183g	19	260	100	25
1461555	20 mm	207g	20	260	100	25
1461655	21 mm	225g	21	280	80	20
1461755	22 mm	240g	22	280	80	20
1461855	23 mm	285g	23	280	80	20
1461955	24 mm	327g	24	305	60	10
1462055	25 mm	337g	25	305	60	10
1462155	26 mm	375g	26	305	60	10
1462255	27 mm	415g	27	320	60	10
1462355	28 mm	450g	28	320	40	10
1462455	29 mm	483g	29	320	40	10
1462555	30 mm	515g	30	360	40	10
1462655	32 mm	595g	32	360	20	5
1462755	36 mm	940g	36	360	20	5

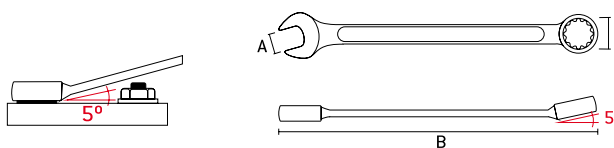

- Acabamento Fosco | Matte Finish | Acabado Mate

Chave Estrela

Star key | Clave estrella



Barcode	Size	Weight (KG)	DIMENSÕES SIZE TAMAÑO (MM)			Pack	Quant. Min.
			A	B	C		
1450155	6 X 7 mm	40g	6	170	7	400	50
1450255	8 X 9 mm	60g	8	190	9	300	20
1450355	10 X 11 mm	90g	10	200	11	200	20
1450455	12 X 13 mm	110g	12	220	13	200	20
1450555	14 X 15 mm	140g	14	240	15	150	10
1450655	16 X 17 mm	180g	16	270	17	100	10
1450755	18 X 19 mm	230g	18	300	19	100	10
1450855	20 X 22 mm	320g	20	330	22	60	5
1450955	21 X 23 mm	370g	21	320	23	60	5
1451055	24 X 26 mm	420g	24	350	26	60	5
1451155	26 X 28 mm	480g	26	360	28	50	5
1451255	27 X 32 mm	640g	27	370	32	40	5
1451355	30 X 32 mm	640g	30	370	32	40	5



- Aço CrV Temperado | Tempered CrV Steel | Acero CrV Templado
- Acabamento Fosco | Matte Finish | Acabado Mate

Chave Combinada

Combined key | Llave Combinada

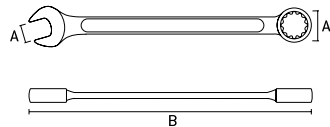

- Aço CrV Temperado de alta qualidade | High Quality Tempered CrV Steel | Acero CrV Templado de alta calidad
- Acabamento Fosco | Matte Finish | Acabado Mate

Barcode	Size	Weight (g)	DIMENSÕES SIZE TAMAÑO (MM)		Box	Quant. Min.
			A	B		
1463055	1/4"	20g	6,350	100	1200	100
1463155	5/16"	30g	7,938	120	600	100
1463255	3/8"	40g	9,525	135	600	50
1463355	7/16"	50g	11,113	150	400	50
1463455	1/2"	80g	12,700	170	300	50
1463555	9/16"	80g	14,288	180	300	30
1463655	5/8"	110g	15,875	200	200	20
1463755	11/16"	130g	17,463	200	200	20
1463855	3/4"	180g	19,050	230	150	10
1463955	13/16"	220g	20,638	250	100	10
1464055	7/8"	260g	22,225	250	100	10
1464155	15/16"	300g	23,813	280	80	10
1464255	1"	330g	25,400	290	80	5
1464355	1.1/16"	390g	26,988	310	60	5
1464455	1.1/8"	460g	28,575	330	50	5
1464555	1.3/16"	500g	30,163	340	40	5
1464655	1.1/4"	570g	31,750	360	40	5

Chave Combinada

Combined key | Llave Combinada



- Acabamento acetinado | Matte Finish | Acabado Mate
- Norma DIN 3113 | Standard DIN 3113 | Norma DIN 3113
- Alta resistência a torções, não quebra e não estilhaça com sobrecarga | High torsional, non-breaking and non-shattering with overload | Alta resistencia a la torsión, no se rompe y no se rompe con sobrecarga

Barcode	Size	Weight (g)	DIMENSÕES SIZE TAMAÑO (MM)		Box	Quant. Min.
			A	B		
151029	6 mm	27g	6	100	300	75
151039	7 mm	30g	7	111	300	75
151049	8 mm	42g	8	123	240	60
151059	9 mm	38g	9	130	240	60
151069	10 mm	55g	10	140	200	50
151079	11 mm	62g	11	150	200	50
151089	12 mm	72g	12	160	200	50
151099	13 mm	95g	13	170	200	20
151109	14 mm	102g	14	182	200	50
151119	15 mm	098g	15	190	200	50
151139	17 mm	130g	17	210	200	50
151159	19 mm	188g	19	230	100	25
151169	20 mm	218g	20	240	100	25
151189	22 mm	270g	22	260	80	20
151199	24 mm	333g	24	280	60	15
151209	27 mm	410g	27	310	50	5
151219	32 mm	648g	32	360	50	5

Chave Combinada com catraca

Combined key | Llave Combinada

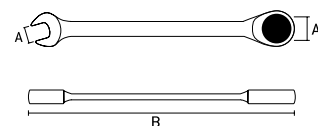

- Cabeça com catraca | Ratchet head | Cabeza con trinquete
- Acabamento Cromado | Chrome Finish | Acabado Cromado
- Norma DIN 3113 | Standard DIN 3113 | Norma DIN 3113
- Permite execução de trabalhos com facilidade e menor esforço usuário | Allows execution of jobs with ease and less user effort | Permite la ejecución de trabajos con facilidad y menor esfuerzo de usuario

Barcode	Size	Weight (g)	DIMENSÕES SIZE TAMAÑO (MM)		Box	Quant. Min.
			A	B		
148019	8 mm	70g	8	200	240	10
148029	9 mm	95g	9	150	240	10
148039	10 mm	90g	10	160	240	10
148049	11 mm	44g	11	165	240	10
148059	12 mm	119g	12	175	200	10
148069	13 mm	135g	13	180	200	10
148079	14 mm	155g	14	193	100	10
148089	15 mm	200g	15	201	150	10
148099	16 mm	210g	16	270	120	5
148109	17 mm	220g	17	228	100	10
148119	18 mm	270g	18	240	100	5
148129	19 mm	296g	19	245	100	5

Chave Combinada com catraca articulada

Combination wrench with articulated ratchet | Llave Combinada con trinquete articulado

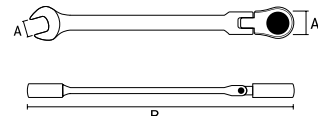

- Cabeça móvel com catraca reversível | Reversible ratchet head | Cabeza móvil con trinquete reversible
- Acabamento Cromado | Chrome Finish | Acabado Cromado

Barcode	Size	Weight (g)	DIMENSÕES SIZE TAMAÑO (MM)		Box	Quant. Min.
			A	B		
148609	8 mm	78g	8	147	240	10
148629	10 mm	105g	10	162	240	10
148649	12 mm	138g	12	170	200	5
148659	13 mm	155g	13	180	100	10
148669	14 mm	160g	14	240	100	10
148699	17 mm	240g	17	283	100	10
148719	19 mm	330g	19	247	100	5

Jogo de Chave Fixa

Combination Key Set | Juego de Llave combinada



Código	Qtd. Peças	Medidas (mm)	Peso (g)	DIMENSÕES SIZE TAMAÑO (MM)		Qtd. Peças	Quant. Min.
				A	B		
152319	6	6mm - 17mm	342g	110	158	60	10
152769	8	6mm - 22mm	641g	141	192	32	8

CrV
Alta
Qualidade

NORMA
DIN 3113

AUTO
SERVIÇO



• **152319 - Composição:**
06 peças de medidas:
6 x 7, 8 x 9, 10 x 11, 12 x 13,
14 x 15 e 16 x 17.

• **152769 - Composição:**
08 peças de medidas:
6x7 - 8x9 - 10x11 - 12x13 - 14x15
16x17 - 18x19 - 20x22 mm

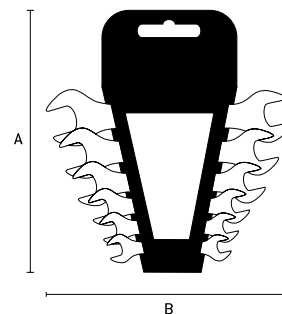

- Norma DIN 3113 | Standard DIN 3113 | Norma DIN 3113
- Acabamento Cromado | Chrome Finish | Acabado Cromado

Jogo de chave estrela

Star key set | Juego de llave estrella



Código	Qtd. Peças	Medidas (mm)	Peso (g)	DIMENSÕES SIZE TAMAÑO (MM)		Qtd. Peças	Quant. Min.
				A	B		
153319	6	6mm - 17mm	710g	112	252	30	5
153329	8	6mm - 22mm	1240g	154	295	20	1

CrV
Alta
Qualidade

NORMA
DIN 3113

AUTO
SERVIÇO



• **153319 - Composição:**
06 peças de medidas:
6x7,8x9,10x11,12x13,14x15,16x17mm

• **153329 - Composição:**
08 peças de medidas:
6 x 7, 8 x 9, 10 x 11, 12 x 13,
14 x 15, 16 x 17, 18 x 19, 20 x 22 mm

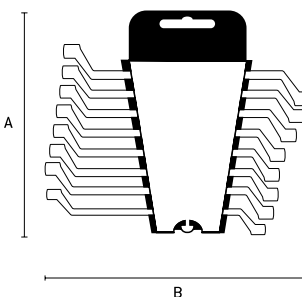

- Norma DIN 3113 | Standard DIN 3113 | Norma DIN 3113
- Para porcas profundas e rebaixadas | For deep and recessed nuts | Para tuercas profundas y rebajadas
- Ângulo de 5° para otimização de transmissão de força | Angle of 5th for power transmission optimization | Ángulo de 5° para optimización de transmisión de fuerza
- Elevada resistência a torção | High torsional resistance | Alta resistencia a la torsión

Jogo de chave Combinada

Combined key set | Juego de clave Combinada



154029	6 peças parts piezas	6mm - 17 mm	390g	101	219	30	5
154089	8 peças parts piezas	6mm - 19mm	755g	130	228	20	5
154129	12 peças parts piezas	6mm - 22mm	1140g	182	258	10	1

CrV
Alta
Qualidade

NORMA
DIN 3113



AUTO
SERVIÇO



154029 | 6 | 8 | 10 | 13 | 14 | 17mm

6
peças
parts / piezas

154089 | 6 | 8 | 10 | 11 | 13 | 14 | 17 | 19 mm

8
peças
parts / piezas

154129 | 6 | 7 | 8 | 9 | 10 | 11 | 12 | 13 | 14 | 17 | 19 | 22mm

12
peças
parts / piezas



Imagem meramente ilustrativa | Merely illustrative image | Imagen meramente ilustrativa

- Norma DIN 3113 | Standard DIN 3113 | Norma DIN 3113
- Acabamento Cromo/Fosco | Chrome Finish / Frosted | Acabado Cromo / Fosco

Jogo de chave fixa

Fixed key set | Juego de llave fija

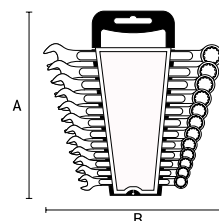

1523655	710g	DIMENSÕES SIZE TAMAÑO (MM)		30	5
		A	B		

Composição | 6X7 | 8X9 | 10X11 | 12X13 | 14X15 | 16X17mm

CrV
Alta
Qualidade

AUTO
SERVIÇO

NORMA
DIN 3113



6
peças
parts | piezas

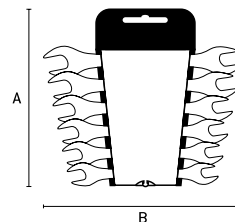

• Aço CrV Temperado de alta qualidade | High Quality Tempered CrV Steel | Acero CrV Templado de alta calidad

Jogo de chave fixa

Fixed key set | Juego de llave fija



1523855	1240g	DIMENSÕES SIZE TAMAÑO (MM)		20	1
		A	B		

Composição | 6X7 | 8X9 | 10X11 | 12X13 | 14X15 | 16X17 | 18X19 | 20X22mm

CrV
Alta
Qualidade

AUTO
SERVIÇO

NORMA
DIN 3113



8
peças
parts | piezas

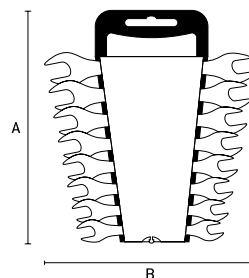

• Aço CrV Temperado de alta qualidade | High Quality Tempered CrV Steel | Acero CrV Templado de alta calidad

Jogo de chave fixa

Fixed key set | Juego de llave fija



1524255	1350g	DIMENSÕES SIZE TAMAÑO (MM)		20	1
		A	B		

Composição | 6X7 | 8X9 | 10X11 | 12X13 | 14X15 | 16X17 | 18X19 | 20X22 | 21X23 | 24X26 | 25X28 | 27X32mm

CrV
Alta
Qualidade

AUTO
SERVIÇO

NORMA
DIN 3113



12
peças
parts | piezas

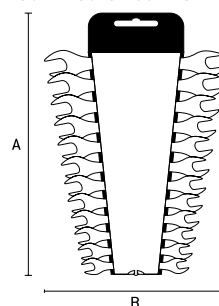

• Aço CrV Temperado de alta qualidade | High Quality Tempered CrV Steel | Acero CrV Templado de alta calidad

Jogo de chave estrela

Fixed key set | Juego de llave fija



1533155	6 peças parts piezas	710g	DIMENSÕES SIZE TAMAÑO (MM)		30	5
			A	B		
1533255	8 peças parts piezas	1240g	154	295	20	1
1533355	12 peças parts piezas	1350g	160	310	20	1

1533155 | 6X7 | 8X9 | 10X11 | 12X13 | 14X15 | 16X17mm

1533255 | 6X7 | 8X9 | 10X11 | 12X13 | 14X15 | 16X17 | 18X19 | 20X22mm

1533355 | 6X7 | 8X9 | 10X11 | 12X13 | 14X15 | 16X17 | 18X19 | 20X22 | 21X23 | 24X26 | 25X28 | 27X32mm

CrV
Alta
Qualidade

AUTO
SERVIÇO

NORMA
DIN 3113

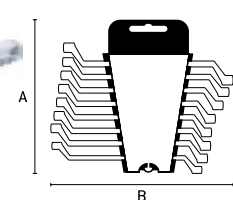

6
peças
parts | piezas

8
peças
parts | piezas

12
peças
parts | piezas



• Aço CrV Temperado de alta qualidade | High Quality Tempered CrV Steel | Acero CrV Templado de alta calidad

Chave Estrela de Bater

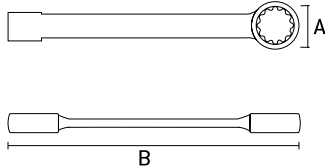

Barcode	SKU	KG	DIMENSÕES SIZE TAMAÑO (MM)			Box	Quant. Min.
			A	B	C		
1426955	24 mm	250g	20	170	46	80	2
1427155	27 mm	311g	20	187	53	80	1
1427355	30 mm	475g	20	197	55	60	2
1427455	32 mm	450g	40	205	60	60	2
1427555	36 mm	600g	22	213	66	40	2
1427655	41 mm	800g	24	240	70	30	1
1427755	46 mm	1050g	25	245	80	24	1
1427855	50 mm	1333g	26	262	87	20	1
1427955	55 mm	1583g	25	280	90	16	1
1428055	60 mm	1588g	28	282	97	16	1

Chave Fixa de Bater

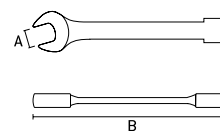

Barcode	SKU	KG	DIMENSÕES SIZE TAMAÑO (MM)			Box	Quant. Min.
			A	B	C		
1428155	24 mm	250g	20	170	46	80	2
1428255	27 mm	311g	20	187	53	80	1
1428355	30 mm	475g	20	197	55	60	2
1428455	32 mm	450g	40	205	60	60	2
1428555	36 mm	600g	22	213	66	40	2
1428655	41 mm	800g	24	240	70	30	1
1428755	46 mm	1050g	25	245	80	24	1
1428855	50 mm	1333g	26	262	87	20	1
1428955	55 mm	1583g	25	280	90	16	1
1429055	60 mm	1588g	28	282	97	16	1

Chave Fixa, CrV, Fosfatizada

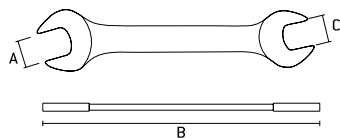

Barcode	SKU	KG	DIMENSÕES SIZE TAMAÑO (MM)			Box	Quant. Min.
			A	B	C		
1432055	6 x 7 mm	30g	20	120	20	1000	50
1432155	8 x 9 mm	40g	20	130	10	600	50
1432255	10 x 11 mm	60g	70	280	15	400	50
1432355	12 x 13 mm	80g	30	170	5	300	25
1432455	14 x 15 mm	100g	30	180	10	250	25
1432555	16 x 17 mm	140g	35	200	10	100	25
1432655	18 x 19 mm	190g	40	220	10	100	10
1432755	20 x 22 mm	230g	45	230	10	100	10
1432855	21 x 23 mm	260g	50	240	10	100	10
1432955	24 x 26 mm	350g	50	260	10	60	5
1433055	25 x 28 mm	430g	60	270	10	50	5
1433155	27 x 32 mm	580g	55	290	10	50	5
1433255	30 x 32 mm	550g	65	280	20	40	5

Chave Estrela, CrV, Fosfatizada

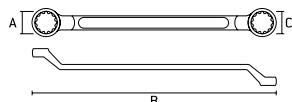

Barcode	SKU	KG	DIMENSÕES SIZE TAMAÑO (MM)			Box	Quant. Min.
			A	B	C		
1465155	6 x 7 mm	40g	25	170	10	400	50
1465255	8 x 9 mm	60g	10	190	30	300	20
1465355	10 x 11 mm	90g	10	200	30	200	20
1465455	12 x 13 mm	110g	10	220	30	200	20
1465555	14 x 15 mm	140g	10	240	35	150	10
1465655	16 x 17 mm	180g	10	270	35	100	10
1465755	18 x 19 mm	230g	20	300	40	100	10
1465855	20 x 22 mm	320g	10	330	40	60	5
1465955	21 x 23 mm	370g	10	320	45	60	5
1466055	24 x 26 mm	420g	40	350	20	60	5
1466155	25 x 28 mm	480g	40	360	20	50	5
1466255	27 x 32 mm	640g	45	370	20	40	5
1466355	30 x 32 mm	640g	45	370	20	40	5

Chave Combinada, CrV, Fosfatizada



CrV
Alta
Qualidade

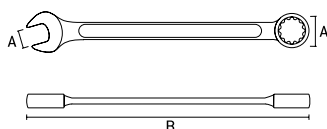

Barcode	KG	DIMENSÕES SIZE TAMAÑO (MM)			Quant. Min.		
		A	B	C			
1490155	6 mm	32g	50	160	8	300	75
1490255	7 mm	39g	50	170	8	300	75
1490355	8 mm	45g	50	170	8	240	60
1490455	9 mm	49g	50	180	10	240	60
1490555	10 mm	61g	50	190	10	200	25
1490655	11 mm	69g	50	200	10	200	25
1490755	12 mm	73g	50	200	10	200	25
1490855	13 mm	89g	50	220	12	200	25
1490955	14 mm	108g	50	220	12	200	25
1491055	15 mm	124g	50	220	12	200	25
1491155	16 mm	139g	50	240	16	120	30
1491255	17 mm	151g	50	240	17	120	30
1491355	18 mm	161g	50	240	17	120	30
1491455	19 mm	183g	50	260	17	100	25
1491555	20 mm	207g	50	260	18	100	25
1491655	21 mm	225g	50	280	20	80	20
1491755	22 mm	240g	50	280	20	80	20
1491855	23 mm	285g	50	280	20	80	20
1491955	24 mm	327g	70	305	20	60	10
1492055	25 mm	337g	70	305	20	60	10
1492155	26 mm	375g	70	305	20	60	10
1492255	27 mm	415g	70	320	22	60	10
1492355	28 mm	450g	70	320	22	40	10
1492455	29 mm	483g	70	320	22	40	10
1492555	30 mm	515g	70	360	25	40	10
1492655	32 mm	595g	70	360	25	20	5

Jogo de Chave Combinada, CrV, Fosfatizada

CrV
Alta
Qualidade



1493055 | 6 | 8 | 10 | 13 | 14 | 17 mm

6
peças
para 1 peça



1493155 | 6 | 8 | 10 | 11 | 12 | 13 | 14 | 17 | 19 mm

8
peças
para 1 peça

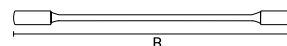

1493255 | 6 | 7 | 8 | 9 | 10 | 11 | 12 | 13 | 14 | 17 | 19 | 22 mm

12
peças
para 1 peça

Barcode	KG	DIMENSÕES SIZE TAMAÑO (MM)			Quant. Min.		
		A	B	C			
1493055	6 x 17 mm - 6 pçs	390g	101	219	38	30	5
1493155	6 x 19 mm - 8 pçs	755g	130	228	38	20	5
1493255	6 x 22 mm - 12 pçs	1140g	182	258	40	10	1

Jogo de Chave Fixa, CrV, Fosfatizada

CrV
Alta
Qualidade



- 1496655 - Composição:
06 peças de medidas:
6 x 7, 8 x 9, 10 x 11, 12 x 13, 14 x 15, 16 x 17 mm
- 1496755 - Composição:
08 peças de medidas:
6x7, 8x9, 10x11, 12x13, 14x15, 16x17, 18x19, 20x22 mm
- 152769 - Composição:
12 peças de medidas:
6x7, 8x9, 10x11, 12x13, 14x15, 16x17, 18x19, 20x22,, 21x23, 24x26, 25x28, 27x32 mm

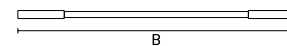
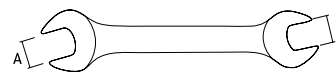

Barcode	KG	DIMENSÕES SIZE TAMAÑO (MM)			Quant. Min.		
		A	B	C			
1496655	6 x 17 mm - 6 pçs	1240g	154	295	35	20	1
1496755	6 x 22 mm - 8 pçs	1350g	160	310	35	20	1
1496555	6 x 32 mm - 12 pçs	710g	112	252	30	30	5

Jogo de Chave Estrela, CrV, Fosfatizada

CrV
Alta
Qualidade



1499555 | 6X7 | 8X9 | 10X11 | 12X13 | 14X15 | 16X17mm

6
peças
para 1 peça



1499655 | 6X7 | 8X9 | 10X11 | 12X13 | 14X15 | 16X17 | 18X19 | 20X22mm

8
peças
para 1 peça

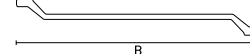

1499755 | 6X7 | 8X9 | 10X11 | 12X13 | 14X15 | 16X17 | 18X19 | 20X22 | 21X23 | 24X26 | 25X28 | 27X32mm

12
peças
para 1 peça

Barcode	KG	DIMENSÕES SIZE TAMAÑO (MM)			Quant. Min.		
		A	B	C			
1499555	6 x 17 mm - 6 pçs	0,710	112	252	30	30	5
1499655	6 x 22 mm - 8 pçs	1,240	154	295	35	20	1
1499755	6 x 32 mm - 12 pçs	1,350	160	310	35	20	1

Chave Starter

Starter wrench | Llave Starter



Código	Tamanho	Peso	DIMENSÕES SIZE TAMAÑO (MM)			Quant. Min.
			A	B	C	
1452155	10 X 11 mm	100g	10	150	11	20
1452255	14 X 16 mm	170g	14	180	16	20
1452355	15 X 17 mm	170g	15	180	17	10
1452455	19 X 22 mm	290g	19	230	22	10
1452555	7/16 X 1/2"	100g	7/16"	150	1/2"	25
1452655	9/16 X 5/8"	170g	9/16"	180	5/8"	20
1452755	3/4 X 7/8"	290g	3/4"	230	7/8"	10

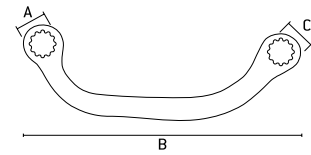

- Meia Lua | Half Moon | Media Luna
- Acabamento Fosco | Matte Finish | Acabado Mate

Jogo de chave Combinada

Combined key set | Juego de clave Combinada



Código	Quantidade	Peso	DIMENSÕES SIZE TAMAÑO (MM)		Quant. Min.
			A	B	
1540355	8 peças parts piezas	710g	112	252	5
1540555	12 peças parts piezas	1240g	154	295	1
1540755	15 peças parts piezas	1350g	160	310	1

1540355 | 8 | 9 | 10 | 11 | 12 | 13 | 14 | 17mm



1540555 | 6 | 7 | 8 | 9 | 10 | 11 | 12 | 13 | 14 | 17 | 19 | 22 mm



1540755 | 6 | 7 | 8 | 9 | 10 | 11 | 12 | 13 | 14 | 17 | 19 | 22 | 24 | 27 | 30 | 32mm



Imagem meramente ilustrativa | Merely illustrative image | Imagen meramente ilustrativa

Cinta para amarração de carga

Load lashing strap | Cinta de amarre de carga



Código	Peso	DIMENSÕES SIZE TAMAÑO (MM)		Quant. Min.
		A	B	
5440355	1450g	220	300	1

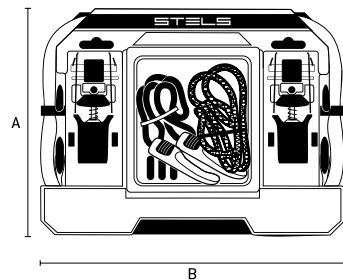

- O kit inclui 2 elásticos com gancho de Ø 0,8 x 0,6 m e Ø 0,8 x 0,8 m e 2 cintas de planas com gancho e catraca de fixação 0,025 mm x 4,50 m | The kit includes 2 elastics with hook of Ø 0,8 x 0,6 m and Ø 0,8 x 0,8 m and 2 straps of flat with hook and ratchet of fixation 0,025 mm x 4,50 m | El kit incluye 2 elásticos con gancho de Ø 0,8 x 0,6 m y Ø 0,8 x 0,8 m y 2 cintas de planas con gancho y trinquete de fijación 0,025 mm x 4,50 m

Cinta para amarração de carga

Load lashing strap | Cinta de amarre de carga

antigo	novo	Capacidade Capacity	Peso	DIMENSÕES SIZE TAMAÑO (MM)		Quant. Min.
				A	B	
54365	543655	700Kg - 0,38X5MT	917g	110	320	1
54366	543665	1000Kg - 0,38X10MT	1250g	160	350	4

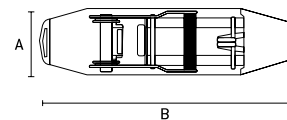

Macaco Hidráulico tipo jacaré 3T

Alligator Type Hydraulic Jack | Gato hidráulico tipo jacaré



antigo	novo	3t/altura min.130 - max.490mm	29,5kg	DIMENSÕES SIZE TAMAÑO (MM)			Quant. Min.
510105	5101055			A	B	1	1

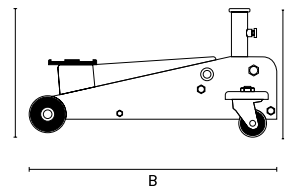

altura min.130mm - max.490mm

- Acompanha cabo | Accompany cable | Acompaña cable
- Embalagem: Caixa Individual | Packing: Individual carton | Embalaje: Caja Individual

Macaco Hidráulico tipo jacaré 2T

Alligator Type Hydraulic Jack | Gato hidráulico tipo jacaré



antigo	novo	2t/altura min.135 - max.300 mm	7,5kg	DIMENSÕES SIZE TAMAÑO (MM)			Quant. Min.
510085	5100855			A	B	1	1

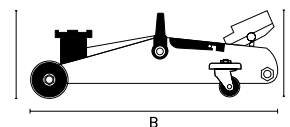

altura min.135 mm - max.300 mm

- Acompanha cabo | Accompany cable | Acompaña cable
- Embalagem: Caixa Individual | Packing: Individual carton | Embalaje: Caja Individual

Macaco Hidráulico tipo jacaré

Alligator Type Hydraulic Jack | Gato hidráulico tipo jacaré



Reforçado com 2 bombas
Reinforced with 2 pumps
Reforzado con 2 bombas

antigo	novo	3 t / altura min.135 - max.465 mm	33,5Kg	DIMENSÕES SIZE TAMAÑO (MM)			Quant. Min.
51133	5113355			A	B	1	1
51135	5113555	3,5 t / altura min.100 - max.565 mm	47Kg	A	B	1	1

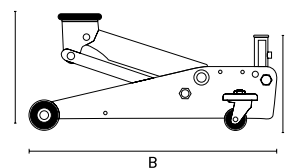

51133 : altura min.135 mm - max.465 mm
51135 : altura min.100mm - max.565 mm

- Acompanha cabo | Accompany cable | Acompaña cable
- Embalagem: Caixa Individual | Packing: Individual carton | Embalaje: Caja Individual

Macaco Hidráulico tipo jacaré 2T

Alligator Type Hydraulic Jack | Gato hidráulico tipo jacaré



	2 t/altura min.135 - max.385 mm	12,8Kg	DIMENSÕES SIZE TAMAÑO (MM)			Quant. Min.
510289			A	B	1	1

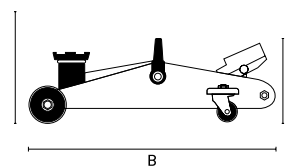

altura min.135mm - max.385 mm

- Portátil | Portable | Portátil
- Acompanha cabo | Accompany cable | Acompaña cable
- Embalagem: Caixa Individual | Packing: Individual carton | Embalaje: Caja Individual

5

Macaco Hidráulico tipo garrafa

Bottle type hydraulic jack | Gato hidráulico tipo botella



antigo	novo	KG	DIMENSÕES SIZE TAMAÑO (MM)		Quant. Min.		
			A	B			
50321	5032155	2 t / altura min.148- max.278 mm	2,19Kg	153	107	10	1
50322	5032255	5 t / altura min.196- max.380 mm	2,33Kg	185	120	5	1
50323	5032355	3 t / altura min.180- max.340 mm	3,62Kg	200	125	5	1
50324	5032455	8 t / altura min.205- max.385 mm	4,95Kg	205	130	4	1
50325	5032555	10 t / altura min.200- max.385 mm	5,55Kg	210	130	4	1

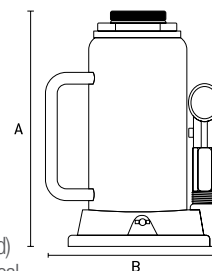

- 1 estágio | 1 stage | 1 práctica
- Com válvula de segurança (para evitar elevação superior a sua capacidade) | With safety valve (to avoid elevation exceeding its capacity) | Con válvula de seguridad (para evitar elevación superior a su capacidad)
- Usar e armazenar somente na posição vertical | Use and store only in upright position | Utilizar y almacenar solamente en posición vertical
- Acompanha cabo | Accompany cable | Acompaña cable
- Embalagem: Caixa Individual | Packing: Individual carton | Embalaje: Caja Individual

Saca polias

Remove pulleys | Saca poleas



antigo	novo	KG	DIMENSÕES SIZE TAMAÑO (MM)		Quant. Min.		
			A	B			
525305	5253055	100mm	436g	55	100	60	1
525355	5253555	150mm	750g	60	150	36	1

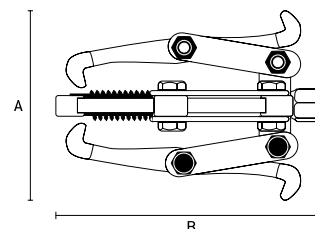

- GARRAS ARTICULADAS | ARTICULATED CLAMPS | GARRAS ARTICULADAS
- Cromada | Chrome plated | cromo
- Uso Leve | Light use | Uso Ligero
- Embalagem: Caixa | Packing: carton | Embalaje: Caja

Chave de corrente

Power switch | Llave de corriente



antigo	novo	KG	DIMENSÕES SIZE TAMAÑO (MM)		Quant. Min.		
			A	B			
528205	5282055	5" (125 mm)	303g	80	125	80	10

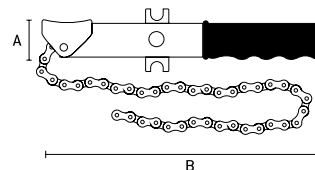

- Tipo leve | Light type | Tipo ligero
- Para filtros | For filters | Para filtros
- Cabo plástico | Plastic cable | Cable de plástico
- Capacidade: 5-125mm | Capacity: 5-125mm | Capacidad: 5-125mm

Almotolia metálica

Metal almotolia | Almotolia metálica



antigo	novo	KG	DIMENSÕES SIZE TAMAÑO (MM)		Quant. Min.		
			A	B			
531305	5313055	300ml	210g	125	70	50	10

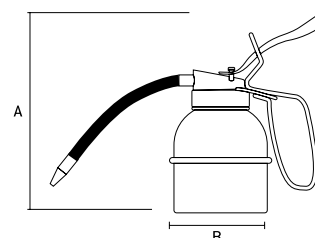

- Bomba para óleo | Oil pump | Bomba de aceite
- Bico Flexível regulável | Adjustable Flexible Nozzle | Boquilla flexible regulable
- Corpo metálico | Metal body | Cuerpo metálico

Chave de Teste

Test Key | Clave de prueba



antigo	novo	6 - 24V	DIMENSÕES SIZE TAMAÑO (MM)		250	Quant. Min.
555205	5552055		A	B		

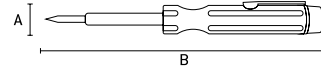

Ideal para identificar cabos rompidos, fusíveis queimados
 Ideal for identifying broken cables, blown fuses
 Ideal para identificar cables rotos, fusibles quemados

- Corpo plástico | Plastic body | Cuerpo plástico
- Corpo para aterramento | Body for grounding | Cuerpo para puesta a tierra
- Indicado para teste de tensão CC | Suitable for CC voltage test | Indicado para prueba de tensión CC

Funil plástico

Plastic funnel | Embudo plástico



5372059	130g	DIMENSÕES SIZE TAMAÑO (MM)		150	1
		A			

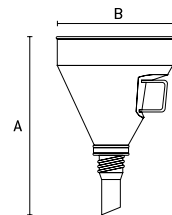

- Flexível | Flexible | Flexible
- Com peneira e alça | With sieve and handle | Con criba y alza
- Diâmetro: 120mm | Diameter: 120mm | Diámetro: 120mm

Abraçadeira rosca sem fim

Endless threaded clamp | Abrazadera rosca sin fin



540025	5400255	8 - 18 mm	31g	500	1
540045	5400455	11 - 20 mm	32g	500	1
540065	5400655	13 - 23 mm	33g	500	1
540085	5400855	14 - 27 mm	34g	500	1
540105	5401055	18 - 25 mm	36g	500	1

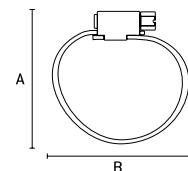

- Aço carbono galvanizado | Carbon steel, galvanized | Acero al carbono galvanizado
- Embalagem com 5 peças | Pack of 5 pieces | Embalaje con 5 piezas

Rodo multiuso

Multipurpose wheel | Rodo multiuso



5521855	20cm	126g	DIMENSÕES SIZE TAMAÑO (MM)		80	20
5521955	16cm	99g	A	B		
5522155	22cm	113g	217	260	80	20

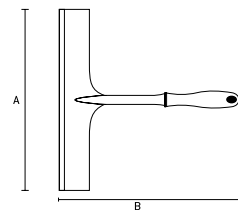

Cabo para Transmissão de Carga de Bateria



5591755	2,5 amperes	700g	20	1
5591955	3 amperes	955g	20	1



5

Filtro de Purificador / Secador de ar

Compressed air filter | Filtro de aire comprimido



570089	1/4"	115g	DIMENSÕES SIZE TAMAÑO (MM)		100	1
			A	B		
			40	90		

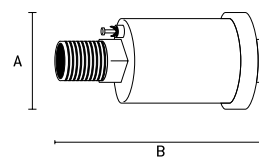

Aplicação
Application
Aplicación

- **Uso profissional** | Professional use | Uso profesional
- **Indicado para retirada de umidade do ar acumulado na mangueira** | Suitable for removing moisture from the air entering the compressor | Indicado para retirar la humedad del aire que entra en el compresor
- **Rosca de 1/4"** | 1/4" thread | Rosca de 1/4"
- **Acessório para todas as ferramentas pneumáticas** | Accessory for all pneumatic tools | Accesorio para todas las herramientas neumáticas
- **Embalagem: caixa** | Packing: Carton | Embalaje: caja

Jogo de engate rápido

Quick coupling kit | Juego de acoplamiento rápido



5701655	1/4" NPT	100g	DIMENSÕES SIZE TAMAÑO (MM)		200	50
			A	B		
			20	45		



BLISTER

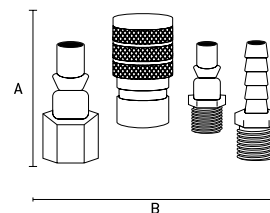

- **Uso profissional e industrial** | Professional and industrial use | Uso profesional e industrial
- **Composição: 4 peças** | Composition: 4 pieces | Composición: 4 piezas

Mangueira espiral de ar

Spiral air hose | Manguera espiral de aire



5700455	1/4" NPT Rosca/Screw/tornillo	340g	DIMENSÕES SIZE TAMAÑO (MM)		50	1
			A	B		
			80	350		
5700555	1/4" NPT Engate rápido Quick coupling/Enganche rápido	340g	DIMENSÕES SIZE TAMAÑO (MM)		50	1
			A	B		
			80	350		

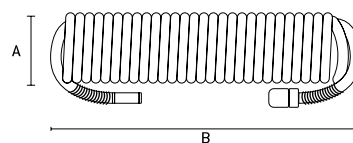

- **Tamanho: 10 metros** | Size: 10 meters | Tamaño: 10 metros

Calibrador de Pneus

Tire Calibrator | Calibrador de Neumáticos



5732255

410g

DIMENSÕES | SIZE | TAMAÑO (MM)
A 290 B 150

40

Quant. Min. 10

AUTO SERVIÇO

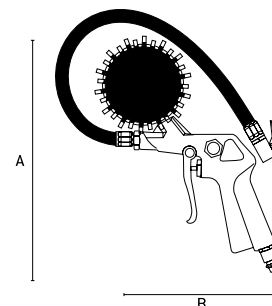

- Mangueira Flexível | Flexible hose | Manguera Flexible
- Bico prendedor para fácil operação | Nipple catch for easy operation | Boquilla prendedor para fácil operación
- Válvula de alívio de pressão | Pressure Relief Valve | Válvula de alivio de presión
- Manômetro para monitoramento de pressão | Pressure gauge for pressure monitoring | Manómetro para monitoreo de presión
- Rosca de 1/4" NPT | 1/4" NPT Thread | Rosca de 1/4" NPT
- Pressão de trabalho 7 BAR (100 PSI)

Jogo de acessórios para compressores

Accessory set for compressors | Juego de accesorios para compresores



5730255
5730455

5pçs, engate rápido
5pçs, engate rápido

DIMENSÕES | SIZE | TAMAÑO (MM)
A 440 B 470
A 450 B 475

10

Quant. Min. 1



- 5730255
 - 1 Pistola de pintura tanque baixo com reservatório de alumínio;
 - 1 Pistola para limpeza bico curto;
 - 1 Mangueira de ar de 5 metros;
 - 1 Calibrador de pneus com manômetro;
 - 1 Pistola pulverizadora tanque baixo com bico longo e reservatório de alumínio.

- 5730455
 - 1 Pistola de pintura tanque alto com reservatório plástico;
 - 1 Pistola para limpeza bico curto;
 - 1 Mangueira de ar de 5 metros;
 - 1 Calibrador de pneus com manômetro;
 - 1 Pistola pulverizadora tanque baixo com bico longo e reservatório de alumínio.

- Pressão de trabalho 7 BAR (100 PSI)
- Pistola para limpeza | Cleaning Pistol | Pistola para limpieza
- Mangueira de ar espiral engate rápido | Spiral air hose quick coupling | Manguera de aire espiral acoplamiento rápido
- Calibrador de pneus | Tire gauge | Calibrador de neumáticos
- Pistola de limpeza bico longo | Long Beak Cleaning Gun | Pistola de limpieza largo largo

5

Pistola de limpeza

Cleaning gun | Pistola de limpieza

AUTO
SERVIÇO



5733055



encaixe rosca 1/4"



170g

DIMENSÕES | SIZE | TAMAÑO (MM)

A

B



100



Quant. Min.
25

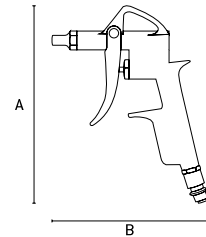

- Curta | Plastic tank top gun | Pistola tanque alto de plástico
- Corpo em alumínio | Cleaning Pistol | Pistola para limpieza
- Acionamento por gatilho | Spiral air hose | Manguera de aire espiral
- Rosca 1/4" NPT | Screw thread | Tornillo
- Pressão de trabalho 7 BAR (100 PSI)

Pistola de limpeza

Cleaning gun | Pistola de limpieza

AUTO
SERVIÇO



5733255



encaixe rosca 1/4"



270g

DIMENSÕES | SIZE | TAMAÑO (MM)

A

B



40



Quant. Min.
25

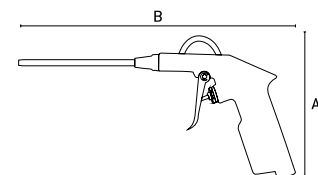

- Indicada para limpeza e secagem de peças, máquinas e equipamentos em geral | Indicated for cleaning and drying of parts, machinery and equipment in general | Indicada para limpieza y secado de piezas, máquinas y equipos en general
- Bico longo | Long beak | Boquilla larga
- Possui gatilho curto para maior praticidade no uso | It has a short trigger for greater practicality in use | Posee gatillo corto para mayor practicidad en el uso
- Corpo plástico | Plastic body | Cuerpo plástico
- Comprimento 135mm | Length 135mm | Longitud 135mm
- Rosca 1/4" NPT | Screw thread | Tornillo
- Pressão de trabalho 7 BAR (100 PSI)

Kit reparo para pistola de pintura

Repair kit for paint spray gun | Kit de reparación para pistola de pintura



Código	Diâmetro (mm)	Peso (g)	DIMENSÕES SIZE TAMAÑO (MM)		Quant. Min.
			A	B	
5738055	1,2mm	88g	90	170	50
5738255	1,5mm	89g	90	170	50
5738455	1,8mm	88g	90	170	50



BLISTER

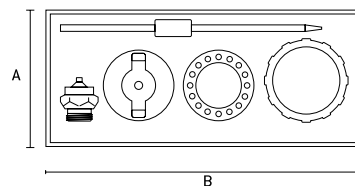

- 4 peças | 4 pieces | 4 piezas
- Bico 1,2 | Nozzle 1,2 | Bico 1,2
- Agulha | Needle | Aguja
- Bocal e abraçadeiras | Nozzle and clamps | Boquilla y abrazaderas

Pistola de jateamento de areia

Sand blasting gun | Pistola de chorro de arena



Código	Capacidade (ml)	Peso (g)	DIMENSÕES SIZE TAMAÑO (MM)		Quant. Min.
			A	B	
5732855		1200g	270	370	1
5732655	1000ml	870g	192	253	1

AUTO SERVIÇO



• 5732855

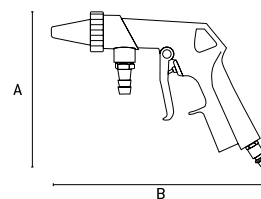

• 5732655

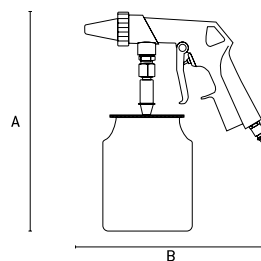

- Alimentação por sucção | Suction feeding | Alimentación por succión
- Tanque baixo | Low tank | Tanque bajo
- Pneumática | Pneumatic | Neumático
- Rosca 1/4" | Thread 1/4" | Rosca 1/4"
- Pressão de trabalho 7 BAR (100 PSI)

5

Pistola de pintura

Spray gun | Pistola de pintura



AUTO SERVIÇO



• 5731455 | 5731555



• 5731855
Aerógrafo | Airbrush | Aerógrafo

Código	Capacidade	DIMENSÕES SIZE TAMAÑO (MM)		Quant. Min.
		A	B	
5731455	600 ml	165	110	1
5731555	1000 ml	225	120	1
5731855	200 ml	170	60	1

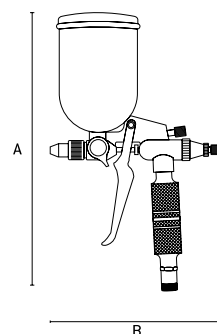
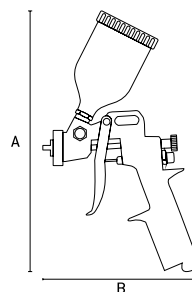

- Alimentação por gravidade | Food by gravity | Alimentación por gravedad
- Tanque alto | High tank | Tanque alto
- Rosca 1/4" | Thread 1/4" | Rosca 1/4"
- Pressão de trabalho 7 BAR (100 PSI)

Pistola de pintura

Spray gun | Pistola de pintura



AUTO SERVIÇO

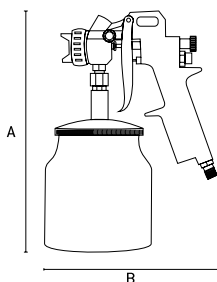

- Alimentação por sucção | Suction feeding | Alimentación por succión
- Tanque baixo | Low tank | Tanque bajo
- Rosca 1/4" | Thread 1/4" | Rosca 1/4"
- Pressão de trabalho 7 BAR (100 PSI)

STELS
VELOCIDADE, CONFIANÇA, ESTILO

AERÓGRAFO
AIRBRUSH | AERÓGRAFO



Imagem meramente ilustrativa



JARDINAGEM

GARDENING | JARDINERÍA

FERRAMENTAS DE JARDIM

Garden's Tools
Herramientas de Jardín

As ferramentas de jardim PALISAD são desenvolvidas para amadores e profissionais da área de jardinagem, para realização de trabalhos com a terra, plantas, irrigação de canteiros, jardins e hortas. Fabricadas com matérias primas de qualidade, garantem um ótimo trabalho e resultado. Oferece um pacote completo de produtos para o seu jardim.

PALISAD garden's tools are designed for amateurs and professionals of the area of gardening, to carry out works with the earth, plants, irrigation of flower beds, gardens and vegetable gardens. Made with quality raw materials, they guarantee a great work and result. Offers a complete package of products for your garden.

Las herramientas de jardín PALISAD se desarrollan para aficionados y profesionales del área de jardinería, para la realización de trabajos con la tierra, plantas, irrigación de jardines, jardines y huertos. Fabricadas con materias primas de calidad, garantizan un excelente trabajo y resultado. Ofrece un paquete completo de productos para su jardín.

SIMBOLOGIA



CÓDIGO
CODE



CARACTERÍSTICAS
Technical Features



PESO DA PEÇA
Part Weight
Peso de la Pieza



CAIXA MASTER
Box Master | Caja Máster



QUANT. MINÍMA
Quant. Minimum
Cantidad Mínima



Canivete para jardim

Garden Knife | Cuchillo para jardín

AUTO SERVIÇO



PALISAD

	790108	66g	DIMENSÕES SIZE TAMAÑO (MM)			100	20*
			A	B	C		
	790118	85g	90	180	30	100	20*

- 790108
Com Espátula |
With Spatula |
Con espátula

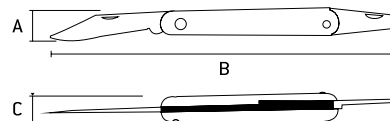

- 790118
Lâmina Curva |
Curved blade |
Lâmina curvada

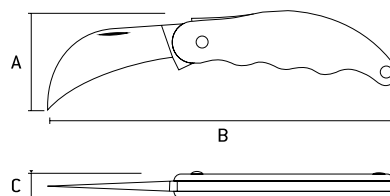

- Cabo Plástico | Plastic Cable | Mango de plástico
- Dobrável | Folding | Plegable

Serrote de poda

Pruning saw | Serrucho de poda

AUTO SERVIÇO



PALISAD

604118	367g	DIMENSÕES SIZE TAMAÑO (MM)			48	1
		A	B	C		
		135	340	25		

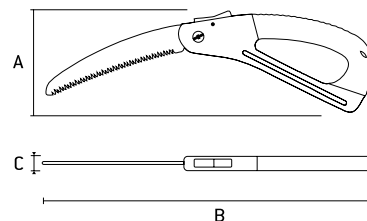

Dobrável com sistema de trava para abertura e fechamento

Folding with locking system for opening and closing | Plegable con sistema de bloqueo para apertura y cierre

- Indicado para cortar galhos secos ou verdes e tubos de PVC |

Suitable for cutting dry or green twigs and PVC pipes | Indicado para cortar ramas secas o verdes y tubos de PVC

- Cabo Plástico | Plastic Cable | Mango de plástico

- Proteção para mão | Hand protection | Protección de mano

- Dentes temperados com sistema de trava e fiação 3D |

Tempered teeth with locking system and 3D wiring | Dientes templados con sistema de trava y cableado 3D

- Embalagem: Blister | Packing: Blister | Embalaje: Blister

Lâmina para serrote de arco

Bow hacksaw blade | Lámina para serrucho de arco

PALISAD

604218	60g	DIMENSÕES SIZE TAMAÑO (MM)			100	1*
		A	B	C		
604238	80g	42	760	2	100	1*

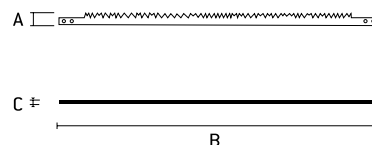

Serrote para galhos 350 mm / 14"

Slicer for branches | Serrucho para ramas



		DIMENSÕES SIZE TAMAÑO (MM)				
605818	350 mm	A	B	C	24	1

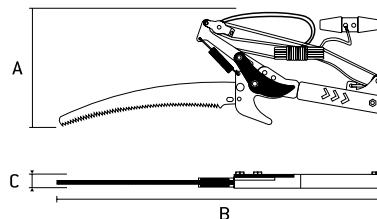

- Aço Y8 | Steel Y8 | Acero Y8
- Cordão de 2,34mt para acionamento da lâmina de corte | 2.34mt cord for cutting blade drive | Cordón de 2,34mt para accionamiento de la cuchilla de corte
- Sem cabo | Without cable | Sin Mango
- Indicado para trabalhos em jardim | Suitable for garden work | Indicado para trabajos en jardín
- Preferível usar para cortar galhos vivos de diâmetro de até 20mm, situados fora do alcance da mão | Preferable to cut live branches up to 20mm diameter, out of reach | Preferible utilizar para cortar ramas vivas de diâmetro de hasta 20mm, situados fuera del alcance de la mano
- Embalagem: Blister | Packing: Blister | Embalaje: Blister

Tesoura para cortar galhos secos e duros

Scissors for cutting hard and dry twigs | Tijeras para cortar ramas secas y duras



		DIMENSÕES SIZE TAMAÑO (MM)				
605328	271g	A	B	C	72	12*

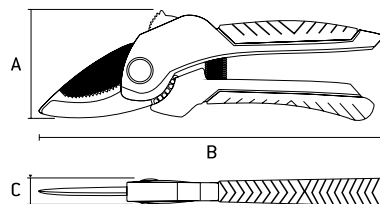

- Para cortar galhos vivos de até 22mm diâmetro | To cut live branches up to 22mm diameter | Para cortar ramas vivas de hasta 22mm de diámetro
- Aço inoxidável | Stainless steel | Acero inoxidable
- Cabo de metal emborrachado | Rubberized metal cable | Mango de metal emborrachado
- Lâmina com revestimento de teflon | Teflon coated blade | Lámina con revestimiento de teflón
- Com trava de segurança e mola | With safety lock and spring | Con traba de seguridad y resorte
- Sistema de alavanca para aumento de força em até 20% com mínimo esforço | Ratchet system for increased cutting with minimum effort | Sistema de trinquete para aumento de corte con mínimo esfuerzo
- Embalagem: Blister | Packing: Blister | Embalaje: Blister

Tesoura para Jardim

Garden Scissors | Tijera para Jardín



		DIMENSÕES SIZE TAMAÑO (MM)				
605368	208g	A	B	C	72	12
605518	208g	130	235	25	72	12
605578	264g	110	250	20	96	24*



• 605368



• 605518



• 605578

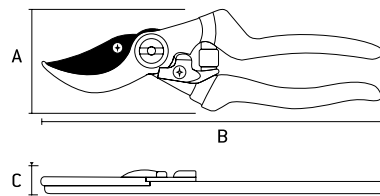
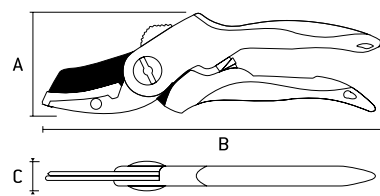
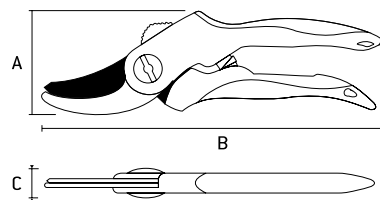

- Para cortar galhos vivos de até 15mm diâmetro | To cut live branches up to 15mm diameter | Para cortar ramas vivas de hasta 15mm de diámetro
- Aço inoxidável | Stainless steel | Acero inoxidable
- Cabo de metal emborrachado | Rubberized metal cable | Mango de metal emborrachado
- Lâmina com revestimento de teflon | Teflon coated blade | Lámina con revestimiento de teflón
- Com trava de segurança e mola | With safety lock and spring | Con traba de seguridad y resorte
- Embalagem: Blister | Packing: Blister | Embalaje: Blister



Tesoura para Jardim

Garden Scissors | Tijera para Jardín

AUTO SERVIÇO



605038	DIMENSÕES SIZE TAMAÑO (MM)			96	Quant. Min.
	A	B	C		

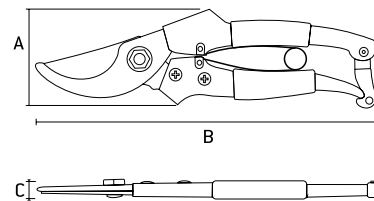

- Para cortar galhos vivos de até 15mm diâmetro | To cut live branches up to 15mm diameter | Para cortar ramas vivas de hasta 15mm de diámetro
- Aço forçado reforçado | Reinforced forged steel | Acero forzado reforzado
- Oxidado anticorrosão | Oxidized anticorrosion | Oxidado anticorrosión
- Cabo plastificado | Plastic cable | Mango plastificado
- Com trava de segurança e mola | With safety lock and spring | Con traba de seguridad y resorte
- Embalagem: Blister | Packing: Blister | Embalaje: Blister

Tesoura para Jardim

Garden Scissors | Tijera para Jardín

AUTO SERVIÇO



6054958	223g	DIMENSÕES SIZE TAMAÑO (MM)			48	Quant. Min.
		A	B	C		

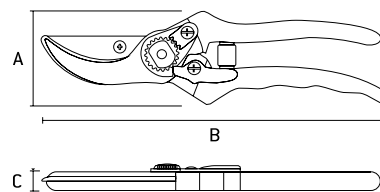

- Para cortar galhos vivos de até 15mm diâmetro | To cut live branches up to 15mm diameter | Para cortar ramas vivas de hasta 15mm de diámetro
- Aço forçado reforçado | Reinforced forged steel | Acero forzado reforzado
- Oxidado anticorrosão | Oxidized anticorrosion | Oxidado anticorrosión
- Cabo emborrachado | Rubberized | cable | Mango emborrachado
- Com trava de segurança e mola | With safety lock and spring | Con traba de seguridad y resorte
- Embalagem: Blister | Packing: Blister | Embalaje: Blister

Tesoura para galhos até 25mm

Scissor for branches up to 25mm | Tijeras para ramas hasta 25mm

AUTO SERVIÇO



605618	333g	DIMENSÕES SIZE TAMAÑO (MM)			48	Quant. Min.
		A	B	C		

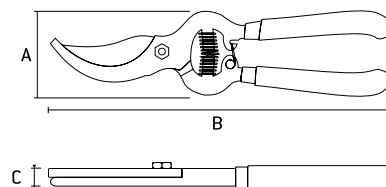

- Podas em Geral | General Pruning | Podras en General
- Lâminas temperadas e bem afiadas | Blades tempered and well honed | Láminas templadas y bien afiladas
- Aço inoxidável | Stainless steel | Acero inoxidable
- Cabo de metal emborrachado | Rubberized metal cable | Mango de metal emborrachado
- Com trava de segurança e mola | With safety lock and spring | Con traba de seguridad y resorte
- Embalagem: Blister | Packing: Blister | Embalaje: Blister

Tesouras corta galhos até Ø25mm

Scissors cuts branches up to Ø25mm | Tijeras corta ramas hasta Ø25mm



DIMENSÕES | SIZE | TAMAÑO (MM)

A B C



605068 1250g 230 700 30 10 1

AUTO SERVIÇO

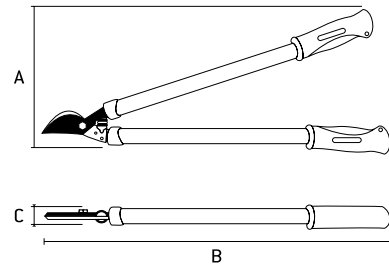

- Aço inoxidável | Stainless steel | Acero inoxidable
- Lâminas temperadas e bem afiadas | Blades tempered and well honed | Láminas templadas y bien afiladas
- Cabo de metal emborrachado | Rubberized metal cable | Mango de metal emborrachado
- Lâmina com revestimento de teflon | Teflon coated blade | Lámina con revestimiento de teflón

Tesouras corta galhos até Ø30mm

Scissors cuts branches up to Ø30mm | Tijeras corta ramas hasta Ø30mm



DIMENSÕES | SIZE | TAMAÑO (MM)

A B C



605208 1250g 345 770 30 10 1*

AUTO SERVIÇO

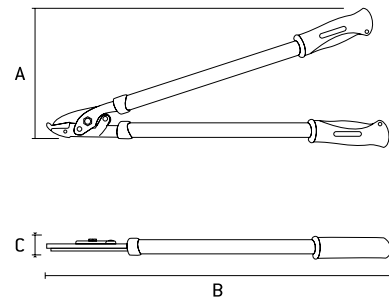

- Aço inoxidável | Stainless steel | Acero inoxidable
- Lâminas temperadas e bem afiadas | Blades tempered and well honed | Láminas templadas y bien afilada
- Cabo de metal emborrachado | Rubberized metal cable | Mango de metal emborrachado
- Lâmina com revestimento de teflon | Teflon coated blade | Lámina con revestimiento de teflón
- Mecanismo de alavanca | Lever mechanism | Mecanismo de palanca

Tesouras corta galhos até Ø25mm

Scissors cuts branches up to Ø25mm | Tijeras corta ramas hasta Ø25mm



DIMENSÕES | SIZE | TAMAÑO (MM)

A B C



605218 813g 260 715 25 12 1

AUTO SERVIÇO

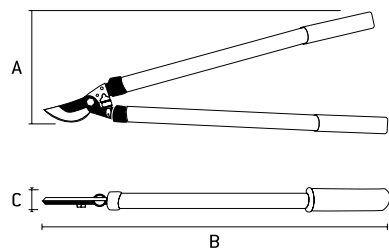

- Aço inoxidável | Stainless steel | Acero inoxidable
- Cabo de metal emborrachado | Rubberized metal cable | Mango de metal emborrachado
- Lâmina com revestimento de teflon | Teflon coated blade | Lámina con revestimiento de teflón

Tesouras corta galhos até Ø35mm

Scissors cuts branches up to Ø35mm | Tijeras corta ramas hasta Ø35mm



DIMENSÕES | SIZE | TAMAÑO (MM)

A B C



605228 1580g 330 810 30 10 1

AUTO SERVIÇO

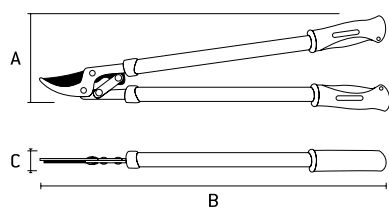

- Aço inoxidável | Stainless steel | Acero inoxidable
- Lâminas temperadas e bem afiadas | Blades tempered and well honed | Láminas templadas y bien afilada
- Cabo de metal emborrachado | Rubberized metal cable | Mango de metal emborrachado
- Lâmina com revestimento de teflon | Teflon coated blade | Lámina con revestimiento de teflón
- Mecanismo de alavanca | Lever mechanism | Mecanismo de palanca



Tesoura para Grama 310mm

Scissors for Grass 310mm | Tijeras para Hierba 310mm



DIMENSÕES | SIZE | TAMAÑO (MM)

A

B



608308

211g

125

310

36

1

AUTO SERVIÇO

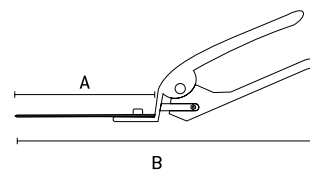

- Aço forjado | General Pruning | Podras en General
- É projetada para cortar grama em gramados e canteiros de flores pequenos | It is designed to cut grass on lawns and small flower beds | Está diseñada para cortar pasto en césped y canteros de flores pequeñas
- Revestimento aço especial oxidado para impedir o processo de corrosão | Special oxidized steel coating to prevent the corrosion process | Revestimiento de acero especial oxidado para impedir el proceso de corrosión
- Cabo de metal | Metal cable | Cable de metal

Tesoura para Grama 330mm

Scissors for Grass 330mm | Tijeras para Hierba 330mm



DIMENSÕES | SIZE | TAMAÑO (MM)

A

B



608628

350g

110

330

40

48

12*

AUTO SERVIÇO

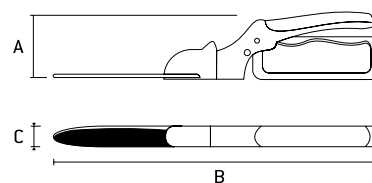
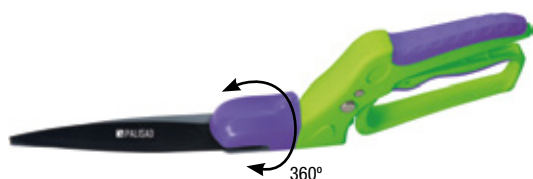

- Aço Forjado | Forged steel | Acero Forjado
- É projetada para cortar grama e canteiros de flores pequenos | It is designed to cut grass and small flower beds | Está diseñado para cortar césped y canteros de flores pequeñas
- Sistema de giro do cabo 360° | Plastic Closure Protector | Protector plástico de cierre
- Revestimento de lâmina de teflon | Teflon blade coating | Mango plástico ABS con guardia
- Embalagem: Blister | Packing: Blister | Embalaje: Bliste

Tesoura para Grama 560mm

Scissors for Grass 560mm | Tijeras para Hierba 560mm



DIMENSÕES | SIZE | TAMAÑO (MM)

A

B



608368

1167g

200

560

55

12

1

AUTO SERVIÇO

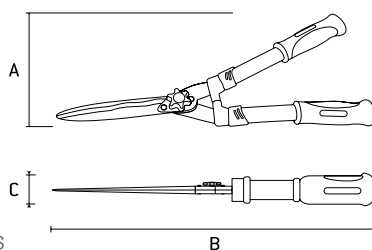

- Lâminas de aço forjado onduladas | Corrugated Forged Steel Blades | Láminas de acero forjado onduladas
- Revestimento anticorrosão (lâminas) | Anti-corrosion coating (blades) | Revestimiento anticorrosión (láminas)
- Cabo plástico revestido de borracha termoplástica | Thermoplastic rubber coated plastic cable | Cable plástico revestido de goma termoplástica
- Protetor plástico de fechamento | Plastic Closure Protector | Protector plástico de cierre

Tesoura para Grama 520mm

Scissors for Grass 520mm | Tijeras para Hierba 520mm



DIMENSÕES | SIZE | TAMAÑO (MM)

A

B



6083758

917g

195

520

35

24

1

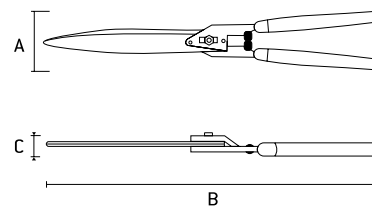

- Lâminas de aço forjado | Forged Steel Blades | Láminas de acero forjado
- Tratamento anticorrosão (lâminas) | Anti-corrosion treatment (slides) | Tratamiento anticorrosión (láminas)
- Cabo de madeira | Wooden handle | Mango de madera
- Protetor plástico de fechamento | Plastic Closure Protector | Protector plástico de cierre

Ancinho / Rastelo 5 dentes

Creep / Rake | Rastrillo / Rizo



617778



244g

DIMENSÕES | SIZE | TAMAÑO (MM)

A

B

C



72



12*

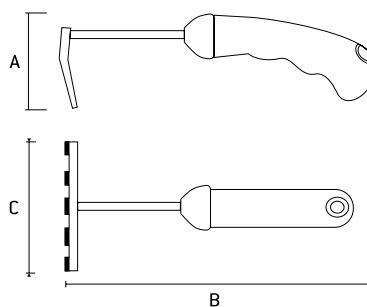

- 5 dentes | 5 teeth | 5 dientes
- Cabo Plástico ABS de dois componentes ergonômico | Cable Plastic ABS two-component ergonomic | Cable Plástico ABS de dos componentes ergonómico
- Corpo metálico com pintura anticorrosão | Metal body with anti-corrosion paint | Cuerpo metálico con pintura anticorrosión

Ancinho / Rastelo 3 dentes

Creep / Rake | Rastrillo / Rizo



623758



226g

DIMENSÕES | SIZE | TAMAÑO (MM)

A

B

C



72



12*

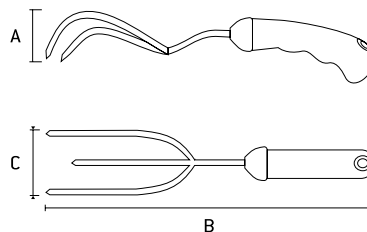

- 3 dentes | 3 teeth | 3 dientes
- Cabo dois componentes ergonômico | Ergonomic two-component cable | Mango dos componentes ergonómicos
- Corpo metálico com pintura anticorrosão | Metal body with anti-corrosion paint | Cuerpo metálico con pintura anticorrosión

Ancinho / Rastelo 3 dentes

Creep / Rake | Rastrillo / Rizo



623858



147g

DIMENSÕES | SIZE | TAMAÑO (MM)

A

B

C



72



12

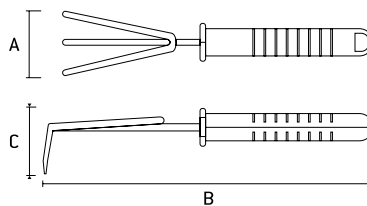

- 3 dentes | 3 teeth | 3 dientes
- Cabo plástico | Plastic cable | Mango de plástico
- Corpo metálico com pintura anticorrosão | Metal body with anti-corrosion paint | Cuerpo metálico con pintura anticorrosión

Garfo 3 dentes

Fork | Tenedor



623878



111g

DIMENSÕES | SIZE | TAMAÑO (MM)

A

B

C



72



12

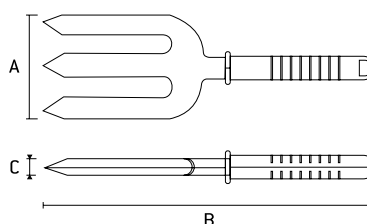

- 3 dentes | 3 teeth | 3 dientes
- Cabo plástico | Plastic cable | Mango de plástico
- Corpo metálico com pintura anticorrosão | Metal body with anti-corrosion paint | Cuerpo metálico con pintura anticorrosión



Extrator de ervas

Herbal extractor | Extractor de hierbas



623218



194g

DIMENSÕES | SIZE | TAMAÑO (MM)

A

B

C



72



12*

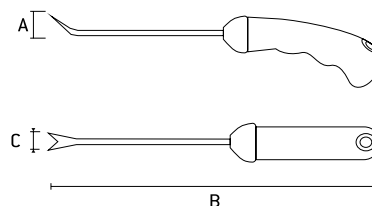

- Cabo dois componentes ergonômico | Ergonomic two-component cable | Mango dos componentes ergonômicos
- Corpo metálico com pintura anticorrosão | Metal body with anti-corrosion paint | Cuerpo metálico con pintura anticorrosión

Extrator de ervas daninhas

Weed extractor | Extractor de malas hierbas



623868

62386



122g

125g

DIMENSÕES | SIZE | TAMAÑO (MM)

A

B

C



72



12

12*

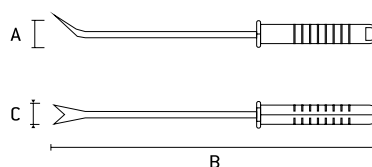

- Cabo plástico | Plastic cable | Mango de plástico
- Corpo metálico com pintura anticorrosão | Metal body with anti-corrosion paint | Cuerpo metálico con pintura anticorrosión

Pazinha

Little Shovel | Pequeña pala



626458

626478



272g

250g

DIMENSÕES | SIZE | TAMAÑO (MM)

A

B

C



72



12*

12*

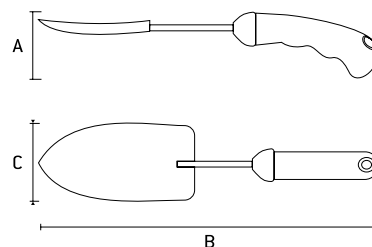

- Cabo dois componentes ergonômico | Ergonomic two-component cable | Mango dos componentes ergonômicos
- Corpo metálico com pintura anticorrosão | Metal body with anti-corrosion paint | Cuerpo metálico con pintura anticorrosión

Pazinha estreita

Little paw | Pala estrecha



626528

626518



118g

99g

DIMENSÕES | SIZE | TAMAÑO (MM)

A

B

C



72



12

12

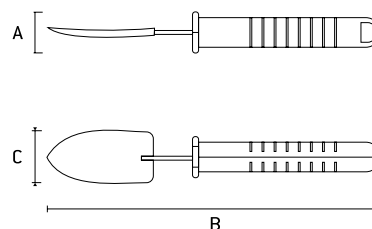

- Cabo plástico | Plastic cable | Mango de plástico
- Corpo metálico com pintura anticorrosão | Metal body with anti-corrosion paint | Cuerpo metálico con pintura anticorrosión

Sacho combinado duas pontas

Hoe combined two ends | Azada combinado duas extremidades



623778



266g

DIMENSÕES | SIZE | TAMAÑO (MM)

A

B

C



72



12*

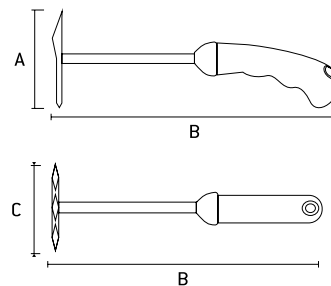

- Cabo dois componentes ergonômico | Ergonomic two-component cable | Mango dos componentes ergonômicos
- Corpo metálico com pintura anticorrosão | Metal body with anti-corrosion paint | Cuerpo metálico con pintura anticorrosión

Sacho combinado duas pontas

Hoe combined two ends | Azada combinado duas extremidades



623898



208g

DIMENSÕES | SIZE | TAMAÑO (MM)

A

B

C



72



12

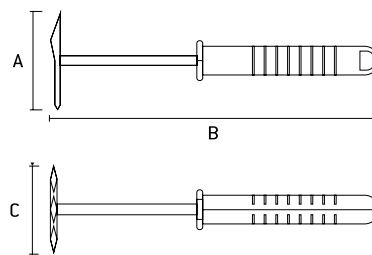

- Cabo plástico | Plastic cable | Mango de plástico
- Corpo metálico com pintura anticorrosão | Metal body with anti-corrosion paint | Cuerpo metálico con pintura anticorrosión

Enxadinha

Small hoe | Azada pequeno



623888



222g

DIMENSÕES | SIZE | TAMAÑO (MM)

A

B

C



72



12

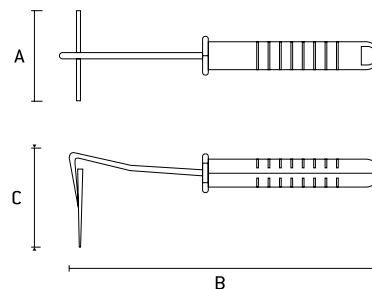

- Cabo plástico | Plastic cable | Mango de plástico
- Corpo metálico com pintura anticorrosão | Metal body with anti-corrosion paint | Cuerpo metálico con pintura anticorrosión



Vassoura para grama e jardim 22 dentes

Grass and garden broom | Escoba para césped y jardín



- Metálica | Metallic | Metálico
- Fixo | Fixed | Fijo
- Sem Cabo | Without cable | Sin Cable

			DIMENSÕES SIZE TAMAÑO (MM)				
617708	22 dentes	300g	A	B	C	30	1

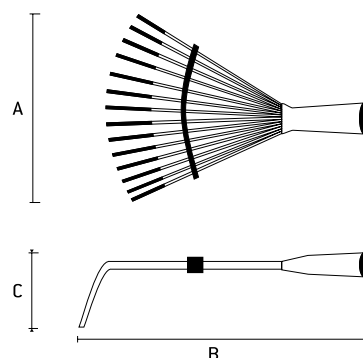

Ancinho / Rastelo

Creep / Rake | Rastrillo / Rizo



- 5 dentes | 5 teeth | 5 dientes
- Cabo de madeira | Wooden handle | Mango de madera
- Corpo metálico com pintura anticorrosão | Metal body with anti-corrosion paint | Cuerpo metálico con pintura anticorrosión

			DIMENSÕES SIZE TAMAÑO (MM)				
617558		194g	A	B	C	72	12

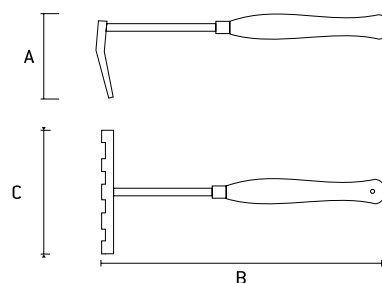

Pazinha

Little Shovel | Pequeña pala



- Cabo de madeira | Wooden handle | Mango de madera
- Corpo metálico com pintura anticorrosão | Metal body with anti-corrosion paint | Cuerpo metálico con pintura anticorrosión

			DIMENSÕES SIZE TAMAÑO (MM)				
626058	larga	250g	A	B	C	72	12
626068	estreita	264g	80	355	85	72	12

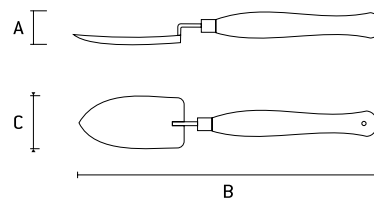

Sacho combinado duas pontas

Hoe combined two ends | Azada combinado duas extremidades



- Cabo de madeira | Wooden handle | Mango de madera
- Corpo metálico com pintura anticorrosão | Metal body with anti-corrosion paint | Cuerpo metálico con pintura anticorrosión

			DIMENSÕES SIZE TAMAÑO (MM)				
623158		168g	A	B	C	72	12

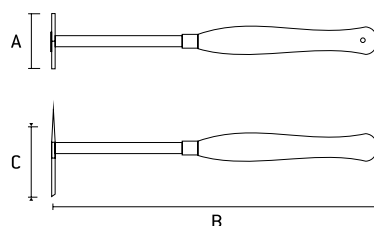

Arrancador de Ervas Daninhas

Pluck herbs | Arrancador de hierbas



623238	148g	DIMENSÕES SIZE TAMAÑO (MM)			60	6
		A	B	C		

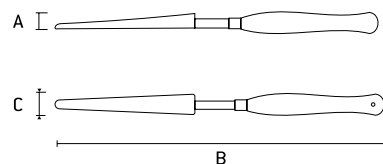

- Cabo de madeira | Wooden handle | Mango de madera
- Corpo metálico com pintura anticorrosão | Metal body with anti-corrosion paint | Cuerpo metálico con pintura anticorrosión

Escardilho

Spud | Escardilho



623538	147g	DIMENSÕES SIZE TAMAÑO (MM)			72	12
		A	B	C		

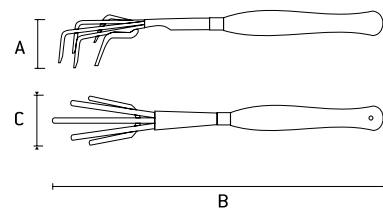

- Cabo de madeira | Wooden handle | Mango de madera
- Corpo metálico com pintura anticorrosão | Metal body with anti-corrosion paint | Cuerpo metálico con pintura anticorrosión

Pazinha

Little Shovel | Pequena pala



630018	estreita	214g	DIMENSÕES SIZE TAMAÑO (MM)			96	6
			A	B	C		
630028	larga	188g	40	310	62	96	6

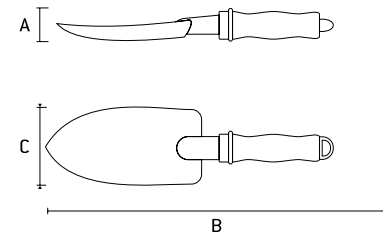

- Cabo de anatómico emborrachado | Rubberized anatomical handle | Mango de anatómico emborrachado
- Pode ser utilizado cabo extensor (630168 e 6030178) | Extender cable (630168 and 6030178) | Se puede utilizar el cable extensor (630168 y 6030178)
- Corpo metálico com pintura anticorrosão | Metal body with anti-corrosion paint | Cuerpo metálico con pintura anticorrosión

Ancinho / Rastelo

Creep / Rake | Rastrillo / Rizo



630038	204g	DIMENSÕES SIZE TAMAÑO (MM)			96	6
		A	B	C		

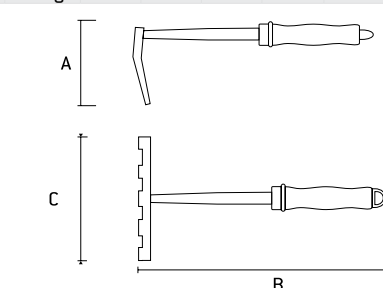

- 5 dentes | 5 teeth | 5 dientes
- Cabo de anatómico emborrachado | Rubberized anatomical handle | Mango de anatómico emborrachado
- Pode ser utilizado cabo extensor (630168 e 6030178) | Extender cable (630168 and 6030178) | Se puede utilizar el cable extensor (630168 y 6030178)
- Corpo metálico com pintura anticorrosão | Metal body with anti-corrosion paint | Cuerpo metálico con pintura anticorrosión



Sacho combinado duas pontas

Hoe combined two ends | Azada combinado duas extremidades



630058	255g	DIMENSÕES SIZE TAMAÑO (MM)			96	6
		A	B	C		
630068	291g	180	282	86	96	6
		170	280	80	96	6



• 630058
Grafo de 2 dentes e enxada |
2-tooth graph and spade |
Grafo de 2 dentes y azada

• 630068
Grafo de 3 dentes e enxada |
3-tooth graph and spade |
Grafo de 3 dentes y azada

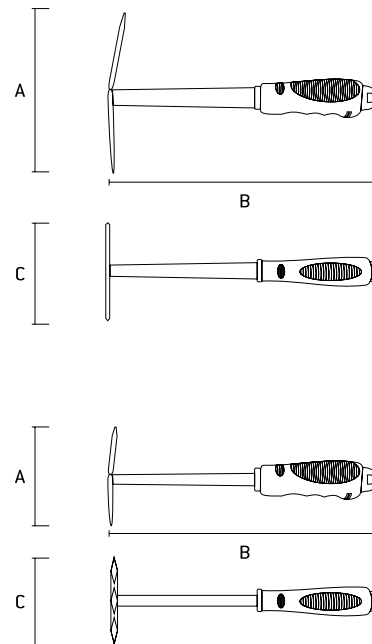

- Cabo de anatômico emborrachado | Rubberized anatomical handle | Mango de anatômico emborrachado
- Pode ser utilizado cabo extensor (630168 e 6030178) | Extender cable (630168 and 6030178) | Se puede utilizar el cable extensor (630168 y 6030178)
- Corpo metálico com pintura anticorrosão | Metal body with anti-corrosion paint | Cuerpo metálico con pintura anticorrosión

Ancinho / Rastelo

Creep / Rake | Rastrillo / Rizo



630088	197g	DIMENSÕES SIZE TAMAÑO (MM)			96	6*
		A	B	C		
		40	340	70	96	6*



- 3 dentes | 3 teeth | 3 dientes
- Cabo de anatômico emborrachado | Rubberized anatomical handle | Mango de anatômico emborrachado
- Pode ser utilizado cabo extensor (630168 e 6030178) | Extender cable (630168 and 6030178) | Se puede utilizar el cable extensor (630168 y 6030178)
- Corpo metálico com pintura anticorrosão | Metal body with anti-corrosion paint | Cuerpo metálico con pintura anticorrosión

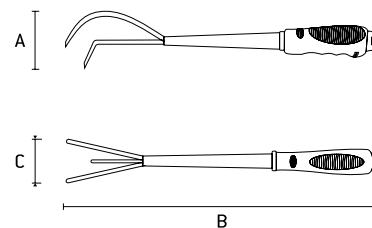

Vassoura para grama e jardim

Grass and garden broom | Escoba para césped y jardín



630078	9 dentes	221g	DIMENSÕES SIZE TAMAÑO (MM)			96	6
			A	B	C		
			40	415	115	96	6



- Cabo de anatômico emborrachado | Rubberized anatomical handle | Mango de anatômico emborrachado
- Pode ser utilizado cabo extensor (630168 e 6030178) | Extender cable (630168 and 6030178) | Se puede utilizar el cable extensor (630168 y 6030178)
- Corpo metálico com pintura anticorrosão | Metal body with anti-corrosion paint | Cuerpo metálico con pintura anticorrosión

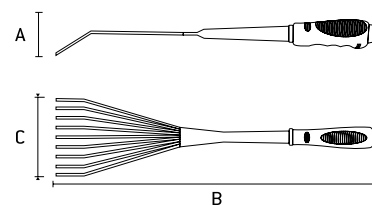

Mini - Pá de bico dobrável

Mini Shovel | Mini - Pala de pico

AUTO
SERVIÇO



614288



1077g

DIMENSÕES | SIZE | TAMAÑO (MM)

A

B



12



Quant. Min.

1

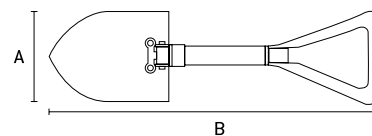

- Metálica | Metallic | Metálico
- Dobrável | Foldable | Plegable
- Sistema de fácil montagem e desmontagem | Easy assembly and disassembly system | Sistema de fácil montaje y desmontaje
- Embalagem protetora | Protective packaging | Embalaje protector

Bordas para jardim

Garden borders | Bordas para jardín



644808



480g

DIMENSÕES | SIZE | TAMAÑO (MM)

A

B



24



Quant. Min.

1*

644818

720g

10cm

9mt

18

1*

644828

809g

15cm

9mt

18

1*

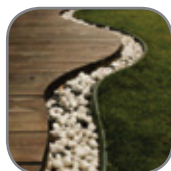
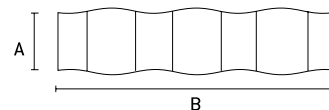

Aplicação
Application
Use

- Plástica | Plastic | Plástico
- Cor: Verde | Green color | Color verde

Bordas para jardim

Garden borders | Bordas para jardín



644838



436g

DIMENSÕES | SIZE | TAMAÑO (MM)

A

B



24



Quant. Min.

1*

644848

720g

10cm

9mt

18

1*

644858

890g

15cm

9mt

18

1*

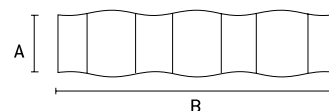

Aplicação
Application
Use

- Plástica | Plastic | Plástico
- Cor: Verde | Green color | Color verde

Jarreteira para jardim

Garden Garter | Jarretera para jardín



			DIMENSÕES SIZE TAMARO (MM)			
644888	bobina	58g	A	B	100	1*

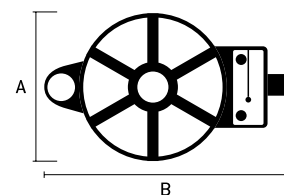

- Fio Macio 20mt | Soft Wire 20mt | Hilo suave 20mt
- Cor: Verde | Green color | Color verde

Balde

Bucket | Cubo

AUTO SERVIÇO



		DIMENSÕES SIZE TAMARO (MM)			
644958	625g	A		24	1*

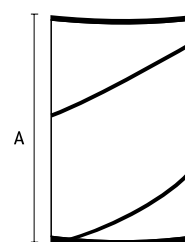

- 95 litros | 95 liters | 95 litros
- Cor: Verde | Green color | Color verde
- Flexível com alças | Flexible with handles | Flexible con tirantes

Cone para plantio

Cone for planting | Cono de plantación



			DIMENSÕES SIZE TAMARO (MM)				
644968	Ø 60mm	312g	A	B	C	50	1*

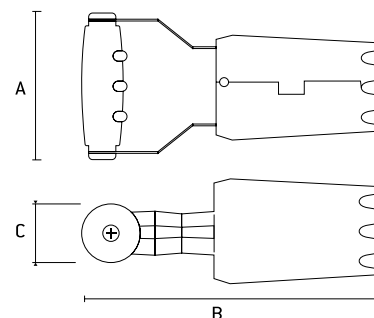

- 60mm Diâmetro | 60mm Diameter | 60mm Diámetro
- Metálica | Metallic | Metálico

Esguicho Pistola

Squirt Gun | Eschicho Pistola

AUTO SERVIÇO



651498



140g

DIMENSÕES | SIZE | TAMAÑO (MM)

A

B

C



Quant. Min.

1

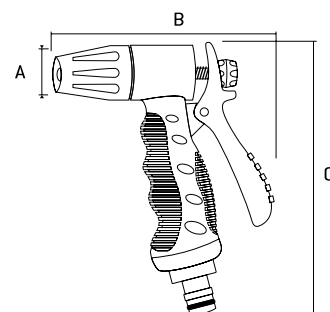

- Corpo plástico anatômico reforçado | Anatomically reinforced plastic body | Cuerpo plástico anatômico reforzado
- Jato regulável | Adjustable jet | Chorro regulable
- Embalagem: Blister | Packing: Blister | Embalaje: Blister

Esguicho Pistola

Squirt Gun | Eschicho Pistola

AUTO SERVIÇO



651618



113g

DIMENSÕES | SIZE | TAMAÑO (MM)

A

B

C



Quant. Min.

1

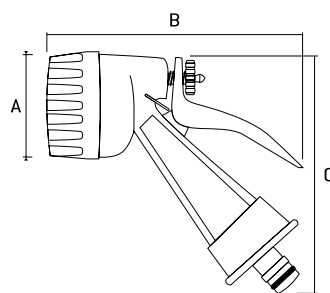

- Jato múltiplos com 7 posições de ajuste | Multiple jet with 7 setting positions | Chorro múltiplos con 7 posiciones de ajuste
- Estrutura em plástico ABS de alta resistência | High resistance ABS plastic frame | Estructura de plástico ABS de alta resistencia
- Embalagem: Blister | Packing: Blister | Embalaje: Blister

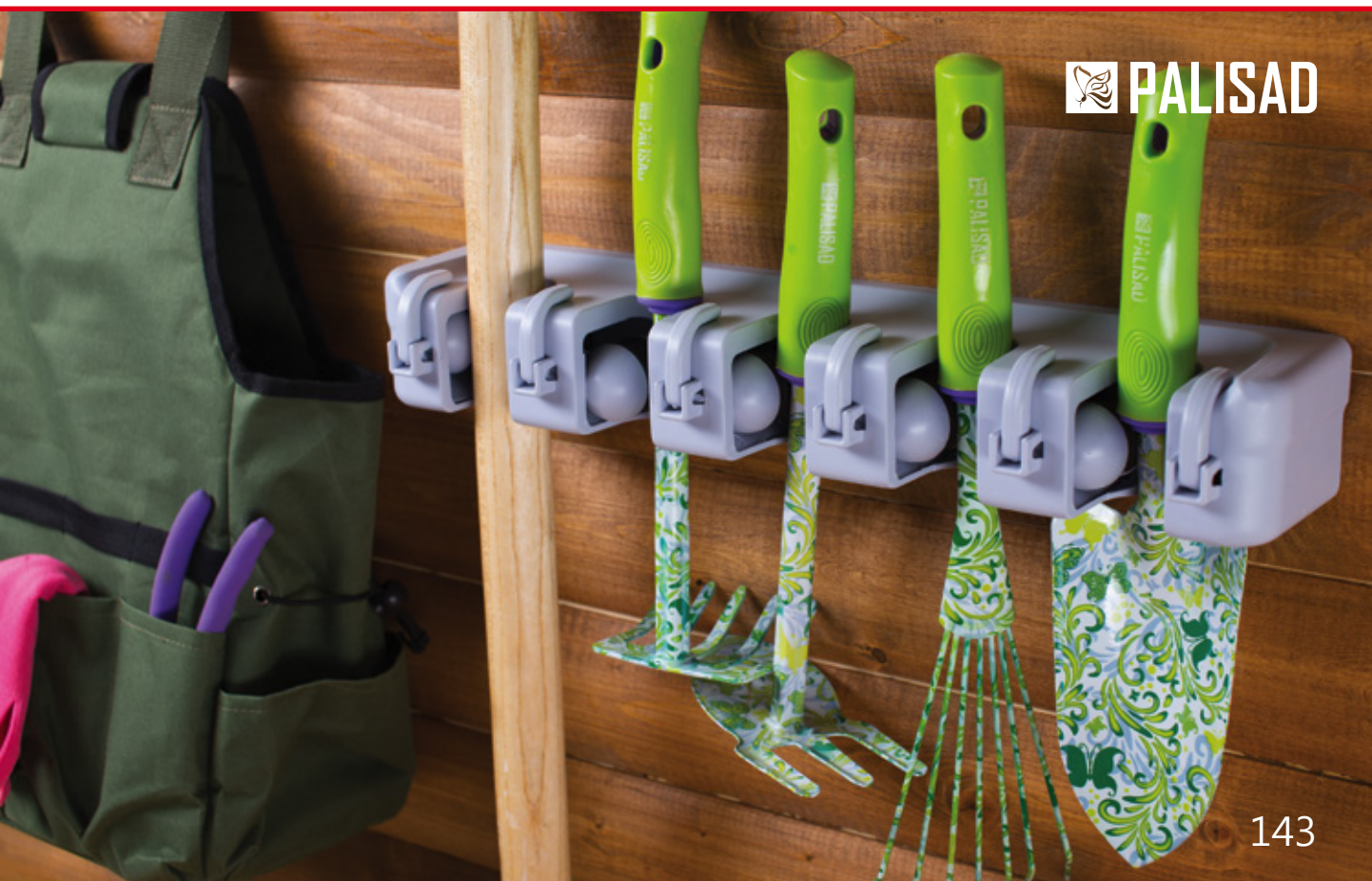

PALISAD

Jogo de conexão para mangueira

Set of connections for hose | Juego de conexiones para la manguera

AUTO SERVIÇO



Barcode	Size	Weight (KG)	Quantity	Min. Quantity
651768	1/2"	194g	72	1
651798	3/4"	111g	72	1

- Estrutura em plástico ABS de alta resistência | High resistance ABS plastic frame | Estructura de plástico ABS de alta resistencia
- Permite conexões rápidas | Allows quick connections | Permite conexiones rápidas
- Equipado com bico ajustável | Equipped with adjustable nozzle | Equipado con pico ajustable
- Oferece três modos de irrigação | It offers three modes of irrigation | Ofrece tres modos de riego
- Composição: 1 Esguicho, 1 conector de torneira e 2 engates rápidos (1 com passagem livre e 1 com bloqueador de passagem) | 1 nozzle, 1 tap connector and 2 quick couplings (1 with free passage and 1 with aquastop) | 1 Eslabón, 1 conector de grifo y 2 enganches rápidos (1 con paso libre y 1 con bloqueador de paso)
- Embalagem: Blister | Packing: Blister | Embalaje: Blister

Válvula pulverizadora

Spray Valve | Válvula pulverizadora



Barcode	Description	Weight (KG)	DIMENSÕES SIZE TAMAÑO (MM)		Quantity	Min. Quantity
			A	B		
647328	para garrafa	31g	300	95	200	1

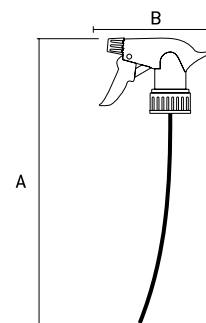

- Não utilizar produtos químicos como solventes ou ácidos | Do not use chemicals such as solvents or acids | No utilizar productos químicos como disolventes o ácidos
- Jato regulável | Adjustable jet | Chorro regulable

Conector triplo para engate rápido

Triple connector for quick coupling | Conector triple para acoplamiento rápido

AUTO SERVIÇO



• 657208

• 657258

• 657358

VENDA POR

Barcode	Description	Weight (KG)	DIMENSÕES SIZE TAMAÑO (MM)		Quantity	Min. Quantity
			A	B		
657208	3/4" para 1/2"	17g	70	110	310	20
657258	3/4"	15g	110	70	320	20
657358	1" para 3/4" e 1/2" rosca interna	29g	70	110	300	20

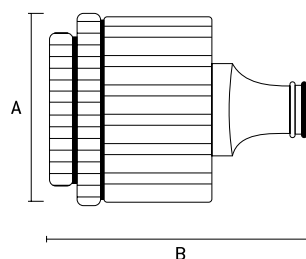
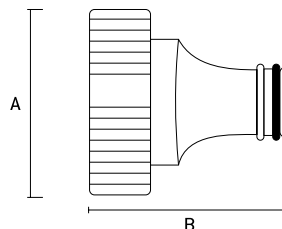
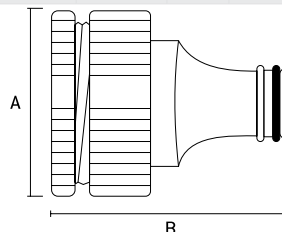

- Estrutura em plástico ABS de alta resistência | High resistance ABS plastic frame | Estructura de plástico ABS de alta resistencia
- Adaptador Fêmea | Female Adapter | Adaptador Hembra
- Para colocação em torneiras de jardim para utilização com engate rápido | For placement on garden taps for use with quick coupling | Para colocación en grifos de jardín para uso con enganche rápido
- Embalagem: Blister | Packing: Blister | Embalaje: Blister

Engate rápido

Quick coupling | Enganche rápido

AUTO SERVIÇO



- 3/4" com bloqueador de passagem e conector macho 3/4", rosca externa | 3/4" with locking mechanism and 3/4" male connector, external thread | 3/4" con bloqueador de paso y conector macho 3/4", rosca externa

VENDA POR

- Estrutura em plástico ABS | ABS plastic frame | Estructura de plástico ABS
- Para conexões de mangueiras de jardim | For garden hose connections | Para conexiones de mangueras de jardín
- Embalagem: Blister | Packing: Blister | Embalaje: Blister

	657558		42g	DIMENSÕES SIZE TAMAÑO (MM)			250		20
				A	B				

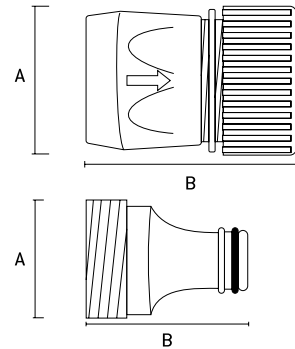

Conector fêmea de plástico com bucha 3/4"

Plastic female connector with bushing | Conector hembra de plástico con casquillo

AUTO SERVIÇO



VENDA POR

- Estrutura em plástico ABS | ABS plastic frame | Estructura de plástico ABS
- Para conexões de mangueiras de jardim | For garden hose connections | Para conexiones de mangueras de jardín
- Embalagem: Blister | Packing: Blister | Embalaje: Blister

	657608		75g	DIMENSÕES SIZE TAMAÑO (MM)			80		20
				A	B				

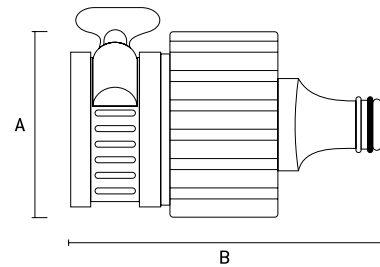

Conector de mangueira 1/2"

Hose connector | Conector de manguera

AUTO SERVIÇO



VENDA POR

- Estrutura em plástico ABS | ABS plastic frame | Estructura de plástico ABS
- Para conexões de mangueiras de jardim | For garden hose connections | Para conexiones de mangueras de jardín
- Com rosca externa para adaptação com irrigadores | With external thread for adaptation with irrigators | Con rosca externa para adaptación con irrigadores
- Embalagem: Blister | Packing: Blister | Embalaje: Blister

	661458		20g	DIMENSÕES SIZE TAMAÑO (MM)			288		20
				A	B				

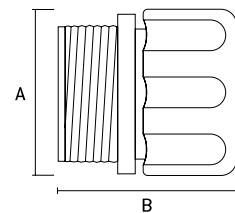

Esguicho Ajustável

Adjustable Spray | Eschicho ajustable

AUTO SERVIÇO



VENDA POR

- Estrutura em plástico ABS de alta resistência | High resistance ABS plastic frame | Estructura de plástico ABS de alta resistencia
- Equipado com bico ajustável | Equipped with adjustable nozzle | Equipado con pico ajustable
- Oferece três modos de irrigação | It offers three modes of irrigation | Ofrece tres modos de riego
- Embalagem: Blister | Packing: Blister | Embalaje: Blister

	651828		42g	DIMENSÕES SIZE TAMAÑO (MM)			288		20
				A	B				

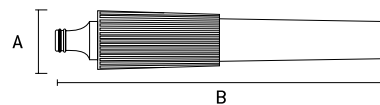

Conectores e adaptadores com engate rápido

Connectors & Adapters | Conectores y adaptadores



• 661358

• 661608



Código	Tamanho	Peso (KG)	DIMENSÕES SIZE TAMAÑO (MM)		Quant. Min.
			A	B	
661358	1/2"	25g	70	110	20
661608	3/4"	33g	70	110	20

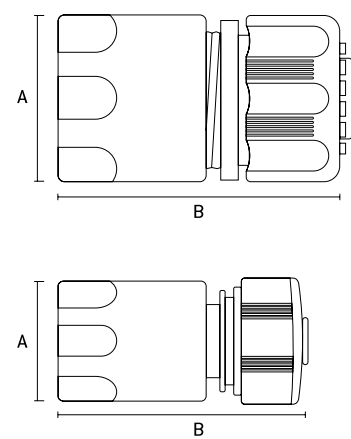

- Estrutura em plástico ABS | ABS plastic frame | Estructura de plástico ABS
- Para conexões de mangueiras de jardim | For garden hose connections | Para conexiones de mangueras de jardín
- Passagem livre de água | Water free passage | Pasaje libre de agua
- Embalagem: Blister | Packing: Blister | Embalaje: Blister

Conectores e adaptadores com engate rápido.

Connectors & Adapters | Conectores y adaptadores



• 661408

• 661658



Código	Tamanho	Peso (KG)	DIMENSÕES SIZE TAMAÑO (MM)		Quant. Min.
			A	B	
661408	1/2"	30g	70	110	20
661658	3/4"	20g	70	110	20

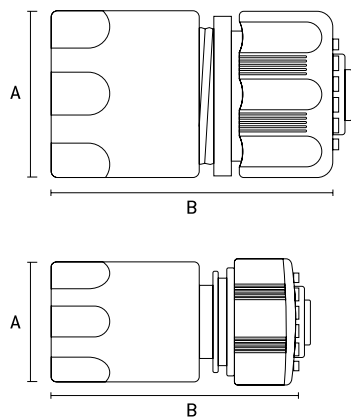

- Estrutura em plástico ABS | ABS plastic frame | Estructura de plástico ABS
- Para conexões de mangueiras de jardim | For garden hose connections | Para conexiones de mangueras de jardín
- Com bloqueador de passagem de água | With water pass-through blocker | Con bloqueador de paso de agua
- Embalagem: Blister | Packing: Blister | Embalaje: Blister

Emenda de mangueira

Hose attachment | Enmienda de manguera



• 664358

• 664418



Código	Tamanho	Peso (KG)	DIMENSÕES SIZE TAMAÑO (MM)		Quant. Min.
			A	B	
664358	1/2"	19g	70	115	20
664418	3/4"	32g	70	115	20

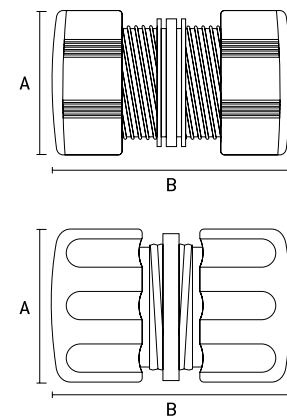

- Estrutura em plástico ABS | ABS plastic frame | Estructura de plástico ABS
- Para conexões de mangueiras de jardim | For garden hose connections | Para conexiones de mangueras de jardín
- Passagem livre de água | Water free passage | Pasaje libre de agua
- Embalagem: Blister | Packing: Blister | Embalaje: Blister

Conector macho

Connector male | Conector macho

AUTO SERVIÇO



661808



13g

DIMENSÕES | SIZE | TAMAÑO (MM)

A

B



500



20

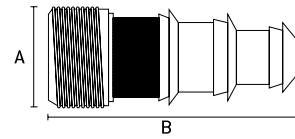

- Corpo plástico | Plastic body | Cuerpo plástico
- Com conexões para mangueira de jardim de 1/2" e 3/4" | With 1/2 "and 3/4" garden hose connections | Con conexiones para manguera de jardín de 1/2 "y 3/4"
- Rosca externa | External thread | Rosca externa
- Embalagem: Blister | Packing: Blister | Embalaje: Blister

Conector duplo para engate rápido

Double connector for quick coupling | Conector doble para enganche rápido

AUTO SERVIÇO



664658



1/2"



11g

DIMENSÕES | SIZE | TAMAÑO (MM)

A

B



500



20

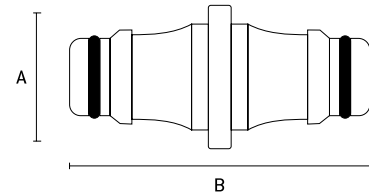

- Corpo plástico ABS | ABS Plastic body | Cuerpo plástico ABS
- Para união de 2 mangueiras de jardim com engate rápido 1/2" | For connection of 2 garden hoses with quick coupling 1/2 " | Para unión de 2 mangueras de jardín con acoplamiento rápido 1/2 "
- Embalagem: Blister | Packing: Blister | Embalaje: Blister

Conector triplo para engate rápido

Triple connector for quick coupling | Conector triple para enganche rápido

AUTO SERVIÇO



664688



1/2"



22g

DIMENSÕES | SIZE | TAMAÑO (MM)

A

B



350



20

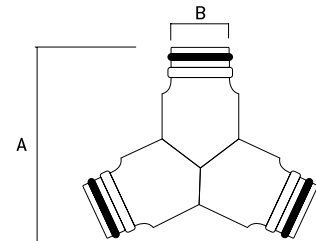

- Corpo plástico ABS | ABS Plastic body | Cuerpo plástico ABS
- Para união de 3 mangueiras de jardim com engate rápido 1/2" | For connection of 3 garden hoses with quick coupling 1/2 " | Para unión de 3 mangueras de jardín con acoplamiento rápido 1/2 "
- Embalagem: Blister | Packing: Blister | Embalaje: Blister

Ligação para 2 saídas ajustáveis

Connection for 2 adjustable outputs | Conexión para 2 salidas ajustables

AUTO SERVIÇO



664268



3/4"



60g

DIMENSÕES | SIZE | TAMAÑO (MM)

A

B



250



20

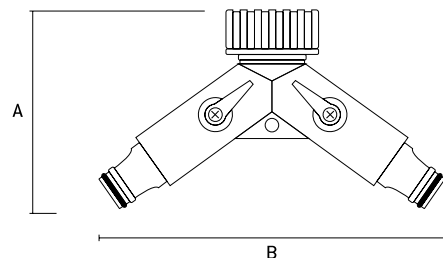

- Corpo plástico ABS | ABS Plastic body | Cuerpo plástico ABS
- Para conexões de mangueira de jardim | For garden hose connections | Para conexiones de manguera de jardín
- Embalagem: Blister | Packing: Blister | Embalaje: Blister



Irrigador rotativo de plástico

Plastic Rotary Irrigator | Irrigador giratorio de plástico



654098	3 jatos	185g	DIMENSÕES SIZE TAMAÑO (MM)			50	1
			A	B	C		

AUTO SERVIÇO

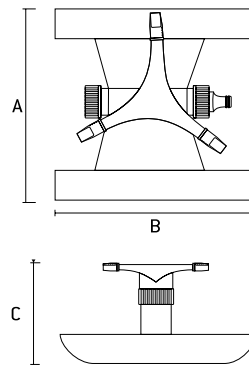

- Estrutura em plástico ABS | ABS plastic frame | Estructura de plástico ABS
- Cabeça móvel giratória | Moving head rotating | Cabeza móvil giratoria
- Gira sob pressão da água | Spin under water pressure | Gira bajo presión del agua
- Alcance reto de 15m | Straight reach of 15m | Alcance recto de 15m
- Alcança uma área de 180m² | It reaches an area of 180m² | Alcance un área de 180m²

Irrigador Múltiplo

Multiple Irrigator | Irrigador Múltiple



654638	6 jatos de modelos diferentes	227g	DIMENSÕES SIZE TAMAÑO (MM)			50	10
			A	B	C		

AUTO SERVIÇO

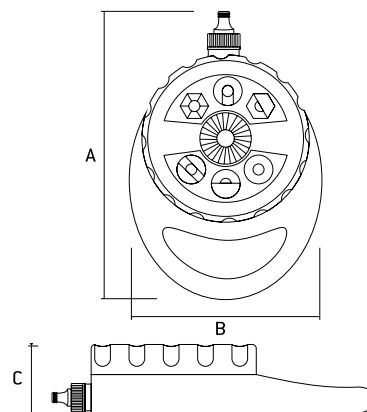

- Estrutura em plástico ABS | ABS plastic frame | Estructura de plástico ABS
- Fornece 8 modos de irrigação | Provides 8 modes of irrigation | Proporciona 8 modos de riego
- Faixa de pulverização de até 12m | Spray range up to 12m | Rango de pulverización de hasta 12m
- Alcança uma área de 113m² | It reaches an area of 113m² | Alcanza un área de 113m²

Irrigador setorial - tipo espiga

Sectorial irrigator - spike type | Irrigador sectorial - tipo espiga



654158	88g	DIMENSÕES SIZE TAMAÑO (MM)		48	1
		A	B		

AUTO SERVIÇO

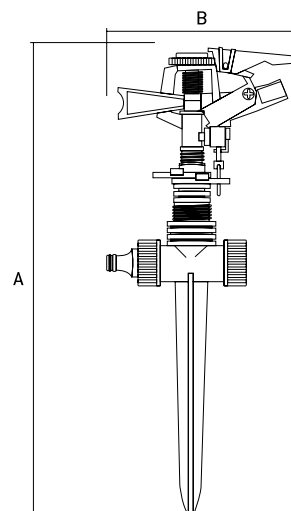

- Mecanismo de ajuste angular | Angular Adjustment Mechanism | Mecanismo de ajuste angular
- Pulverização a partir de 30° a 360° | Spraying from 30° to 360° | Pulverización a partir de 30° a 360°
- O raio do spray de até 12m | Spray radius up to 12m | El rayo del aerosol de hasta 12m
- Alcança uma área de 450m² | It reaches an area of 450m² | Alcanza un área de 450m²
- Embalagem: Blister | Packing: Blister | Embalaje: Blister

Abraçadeira

Clamp | Ábrazadera

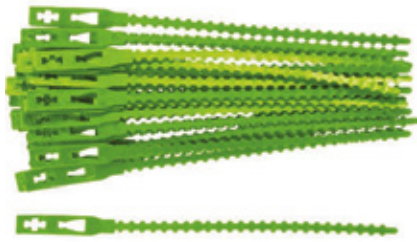

		DIMENSÕES SIZE TAMAÑO (MM)			
644948	49g	A	B	200	5*

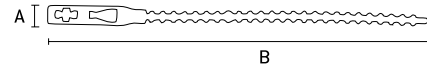

- Em poliéster nitrílico | In nitrilic polyester | En poliéster nitrílico
- Cor verde | Green color | Color verde
- Embalagem: Blister | Packing: Blister | Embalaje: Blister

Pulverizadores agrícolas

Agricultural Sprayers | Pulverizadores agrícolas



			DIMENSÕES SIZE TAMAÑO (MM)			
647358	1,25 litros	113g	A	B	40	1
647388	2 litros	395g	380	130	15	1
647408	5 litros	1133g	407	183	6	1
647508	7 litros	1320g	470	180	6	1
647858	20 litros	3550g	180	350	1	1

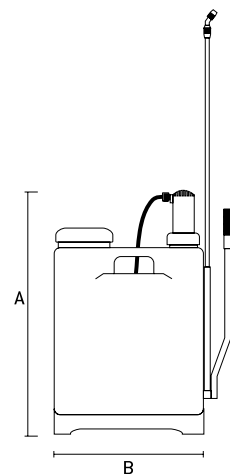
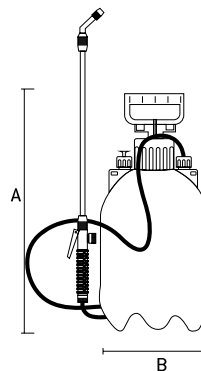
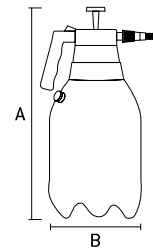
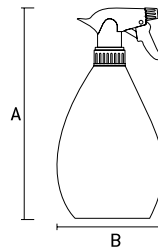

- Compressão prévia | Previous compression | Compresión previa
- Não utilizar produtos químicos como solventes ou ácidos | Do not use chemicals such as solvents or acids | No utilizar productos químicos como disolventes o ácidos
- Possui haste para pressurização | Has pressurizing rod | Posee vástago para presurización
- Válvula de segurança para avaliar pressão do reservatório | Safety valve to assess reservoir pressure | Válvula de seguridad para evaluar la presión del depósito
- Bico com jato regulável | Nozzle with adjustable jet | Boquilla con chorro regulable
- Alça regulável para transporte | Adjustable strap for transport | Alza regulable para el transporte



6

Kit de reparo para pulverizadores

Spray Repair Kit | Kit de reparación para pulverizadores

AUTO SERVIÇO



Barcode	Description	Weight	Volume	Quant. Min.
6474055	para 5 e 7 litros	50	2	2
6478555	para 20 litros	50	2	2



- Jogo de acessórios para produtos 647408, 647508 e 647858 | Accessory kit for products 647408, 647508 and 647858 | Juego de accesorios para productos 647408, 647508 y 647858
- Borrachas | Rubber | Cauchos
- Mangueiras | Hoses | Mangueras
- Bicos de pulverização | Spray Nozzles | Boquillas de pulverización

Luvras para Jardim

Garden gloves | Guantes de jardín

AUTO SERVIÇO



Barcode	TAMANHO SIZE	Weight	DIMENSÕES SIZE TAMAÑO (MM)		Weight	Quant. Min.
			A	B		
677428	TAMANHO SIZE M	47g	70	250	120	12
677438	TAMANHO SIZE L	39g	15	260	120	12

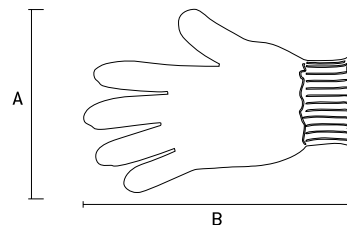

- Em poliéster nitrílico | In nitrilic polyester | En poliéster nitrílico
- Cor verde | Green color | Color verde
- Embalagem: Blister | Packing: Blister | Embalaje: Blister

Luvras para Jardim

Garden gloves | Guantes de jardín

AUTO SERVIÇO



Barcode	TAMANHO SIZE	Weight	DIMENSÕES SIZE TAMAÑO (MM)		Weight	Quant. Min.
			A	B		
677628	TAMANHO SIZE M	51g	70	270	300	12
677638	TAMANHO SIZE L	58g	70	260	300	12

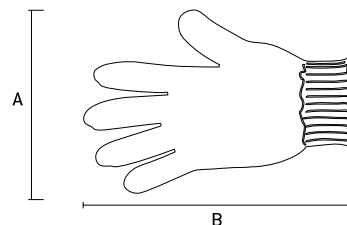

- Tricotada | Knitted | Tejido de punto
- Pigmentação em PVC | Pigmentation in PVC | Pigmentación en PVC
- Embalagem: Blister | Packing: Blister | Embalaje: Blister

Mesas dobráveis de alumínio com tampo de MDF

Aluminum folding tables with MDF tops | Mesas plegables de aluminio con tableros de MDF



Barcode	DIMENSÕES SIZE TAMAÑO (MM)				Weight	Quant. Min.
	A1	A2	B	C		
695828	250	590	600	450	6	1
695838	300	700	900	600	6	1

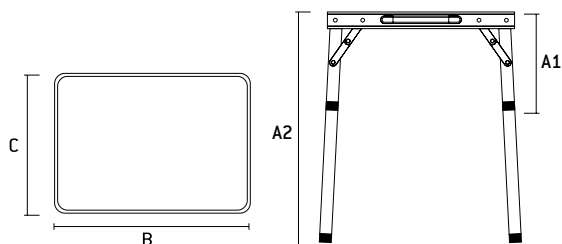

Gazebo de poliéster estrutura articulada

Polyester Gazebo articulated structure | Gazebo de poliéster estrutura articulada



- À prova d'água | Waterproof | A prueba de agua
- Fácil de montar e desmontar

6952055	azul	6kg	DIMENSÕES SIZE TAMAÑO (MM)			1	1
			A	B	C		
6952155	verde listrado	6kg	3m	3m	2,5m	1	1

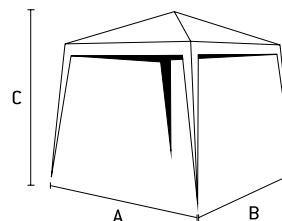

Gazebo de polyester estrutura versátil

Versatile structure polyester gazebo | Gazebo de poliéster estrutura versátil



- À prova d'água | Waterproof | A prueba de agua
- Fácil de montar e desmontar

6952255	azul	6kg	DIMENSÕES SIZE TAMAÑO (MM)			1	1
			A	B	C		
6952355	verde listrado	6kg	3m	3m	2,5m	1	1

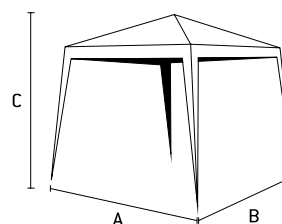

Bolsa térmica de poliéster

Polyester thermal bag | Bolsa térmica de poliéster



695988



633g

DIMENSÕES | SIZE | TAMAÑO (MM)

A B C

210 280 200



15



1*

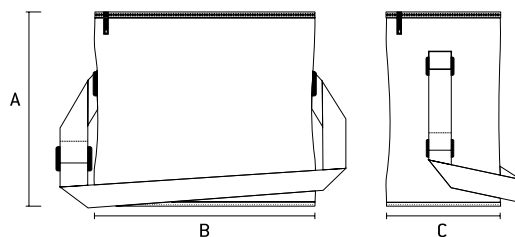

- Contém 1 bloco de gel térmico (PARA FAZER GELO) |

Contains 1 block of thermal gel (TO MAKE ICE) | Contiene 1 bloque de gel térmico (PARA HACER HIELO)

Kit Churrasco

Barbecue kit | Kit Barbacoa



7914955



7 peças



633g

DIMENSÕES | SIZE | TAMAÑO (MM)

A B C

255 355 50



50



1

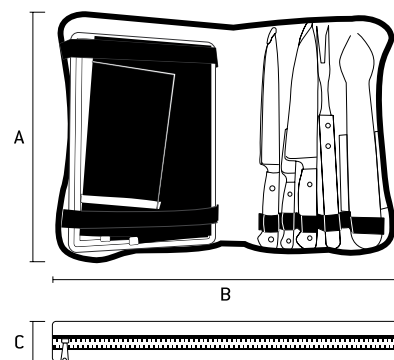

- 1 faca para carne Chef 9" | 1 Knife for Meat Chef 9" | 1 Cuchillo para carne Chef 9"
- 1 faca para carne Chef 8" | 1 Knife for Meat Chef 8" | 1 Cuchillo para carne Chef 8"
- 1 faca para legumes 4" | 1 knife for vegetables 4" | 1 Cuchillo para verduras 4"
- 1 pegador de carne | 1 meat picker | 1 pegador de carne
- 1 garfo trinchante | 1 Shredding fork | 1 horquilla trinchante
- 1 avental | 1 Apron | 1 Delantal
- 1 tábuá de madeira (30x20x1,5cm) | 1 Wooden board (30x20x1,5cm) | 1 Tabla de madera (30x20x1,5cm)



CORTE

CUT | CORTE

FERRAMENTAS DE CORTE

CUT'S TOOLS
HERRAMIENTAS DE CORTE

As ferramentas de corte MTX e SPARTA proporcionam ao profissional ou consumidor final um produto de extrema eficiência para o trabalho a ser desenvolvido. Utilizando matérias primas de qualidade as ferramentas tem um ótimo desempenho e proporcionam um excelente resultado.

The cutting tools MTX and SPARTA provide the professional or final consumer with a product of extreme efficiency for the work to be developed. Using quality raw materials the tools have a great performance and provide an excellent result.

Las herramientas de corte MTX y SPARTA proporcionan al profesional o consumidor final un producto de extrema eficiencia para el trabajo a ser desarrollado. Utilizando materias primas de calidad las herramientas tienen un óptimo desempeño y proporcionan un excelente resultado.

SIMBOLOGIA



CÓDIGO
CODE



CARACTERÍSTICAS
Technical Features



PESO DA PEÇA
Part Weight
Peso de la Pieza



CAIXA MASTER
Box Master | Caja Máster



QUANT. MINÍMA
Quant. Minimum
Cantidad Mínimo



Jogo de brocas de 3 pontas para madeira

Set of 3-prong drill bits for wood | Juego de brocas de 3 puntas para madera



8
peças
parts | piezas

• Composição | Composition | Composición
3,014,015,016,017,018,019,0110,0mm

antigo	novo	DIMENSÕES SIZE TAMAÑO (MM)	DIMENSÕES SIZE TAMAÑO (MM)		Quant. Min.	
			A	B		
702125	7021255	3 mm (1/8")	3	60	100	6
		4 mm (5/32")	4	75		
		5 mm (3/16")	5	85		
		6 mm (1/4")	6	92		
		7 mm (9/32")	7	102		
		8 mm (5/16")	8	110		
		9 mm (3/8")	9	115		
		10 mm (13/32")	10	122		



- Indicada para madeira e derivados | Suitable for wood and derivatives | Indicada para madera y derivados
- Possui ponta com afiação que facilita a centralização do furo | It has a sharpening point that facilitates the centering of the hole | Posee punta con afilado que facilita la centralización del agujero
- Aço especial | Special steel | Acero especial

Jogo de brocas longa para madeira

Set of long drills for wood | Juego de fresas largas para madera

AUTO SERVIÇO



6
peças
parts | piezas

• Composição | Composition | Composición
6,018,0110,0112,0113,0114,0mm

antigo	novo	DIMENSÕES SIZE TAMAÑO (MM)	DIMENSÕES SIZE TAMAÑO (MM)		Quant. Min.	
			A	B		
7023055		6 mm (1/4")	6	300	100	6
		8 mm (5/16")	8	300		
		10 mm (13/32")	10	300		
		12 mm (15/32")	12	300		
		13 mm (1/2")	13	300		
		14 mm (9/16")	14	300		



- Indicada para madeira e derivados | Suitable for wood and derivatives | Indicada para madera y derivados
- Possui ponta com afiação que facilita a centralização do furo | It has a sharpening point that facilitates the centering of the hole | Posee punta con afilado que facilita la centralización del agujero
- Aço especial e Haste cilíndrica | Special Steel and Cylindrical Rod | Acero especial y Vástago cilíndrico
- Embalagem: Plástica/autoserviço | Packing: Plastic / Self Service | Embalaje: Plástico / auto servicio

Broca espiral para madeira

Spiral drill for wood | Taladro espiral para madera

AUTO SERVIÇO



antigo	novo	DIMENSÕES SIZE TAMAÑO (MM)	DIMENSÕES SIZE TAMAÑO (MM)		Quant. Min.	
			A	B		
701029		12 mm (15/32")	12	230	100	50
701049		14 mm (9/16")	14	230	100	50
701069		16 mm (5/8")	16	230	100	50
701089		20 mm (25/32")	20	230	100	50
701109		25 mm (1")	25	230	50	1
701129		32 mm (1.1/4")	32	230	25	1
701209		12 mm (15/32")	12	460	50	25
701229		14 mm (9/16")	14	460	50	25
701249		16 mm (5/8")	16	460	50	25
701269		20 mm (25/32")	20	460	30	15
701289		25 mm (1")	25	480	25	5



- Indicada para madeira maciça e derivados | Suitable for solid wood and derivatives | Indicada para madera maciza y derivados
- Possui ponta com afiação que facilita a centralização do furo | It has a sharpening point that facilitates the centering of the hole | Posee punta con afilado que facilita la centralización del agujero
- Haste sextavada | Hexagon rod | Vástago hexagonal
- Acabamento fosfatizado no veio de corte | Phosphatized Finishing on Cutting Shaft | Acabado fosfatizado en el eje de corte
- Uso profissional | Professional use | Uso profesional
- Embalagem: Plástica/autoserviço | Packing: Plastic / Self Service | Embalaje: Plástico / auto servicio

Jogo de brocas chatas para madeira

Set of boring wood drills | Juego de brocas para madera



antigo	novo	DIMENSÕES SIZE TAMAÑO (MM)		Quant. Min.		
		A	B			
704055	7040555	10 mm (13/32")	10	150	50	1
		12 mm (15/32")	12	150		
		16 mm (5/8")	16	150		
		18 mm (23/32")	18	150		
		20 mm (25/32")	20	150		
		25 mm (1")	25	150		

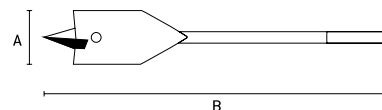

- Indicada para lâminas/chapas finas | Suitable for wood and derivatives | Indicada para madera y derivados
- Possui ponta com afiação que facilita a centralização do furo | It has a sharpening point that facilitates the centering of the hole | Posee punta con afilado que facilita la centralización del agujero
- Haste polida e envernizada sextavada | Hexagonal polished and varnished rod | Vástago pulido y barnizado hexagonal
- Embalagem: Blister | Packing: Blister | Embalaje: Blister

Broca chata para madeira

Flat boring drill | Broca plana para madera



antigo	novo	DIMENSÕES SIZE TAMAÑO (MM)		Quant. Min.	
		A	B		
704009	6 mm (1/4")	6	150	300	75
704019	8 mm (5/16")	8	150	300	75
704049	10 mm (13/32")	10	150	300	75
704079	12 mm (15/32")	12	150	300	75
704089	14 mm (9/16")	14	150	300	75
704099	16 mm (5/8")	16	150	300	75
704109	18 mm (23/32")	18	150	300	75
704149	22 mm (7/8")	22	150	300	75
704159	24 mm (15/16")	24	150	300	75
704169	25 mm (1")	25	150	300	75
704249	32 mm (1.1/4")	32	150	240	60
704309	38 mm (1.1/2")	38	150	240	60
704339	45 mm (1.25/32")	45	150	240	60
704349	50 mm (2")	50	150	200	50

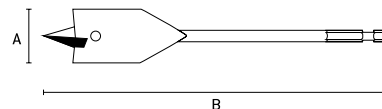

- Para madeira, MDF, MDP, compensado plástico | For wood, MDF, MDP, plastic plywood | Para madera, MDF, MDP, contrachapado plástico
- Indicada para lâminas/chapas finas | Suitable for wood and derivatives | Indicada para madera y derivados
- Possui ponta com afiação que facilita a centralização do furo | It has a sharpening point that facilitates the centering of the hole | Posee punta con afilado que facilita la centralización del agujero
- Embalagem: Blister | Packing: Blister | Embalaje: Blister

Broca de Fresa para dobradiça

Flat boring drill | Broca plana para madera



antigo	novo	DIMENSÕES SIZE TAMAÑO (MM)		Quant. Min.
		Ø	A	
704899	32	26	200	10
704909	35	26	200	10

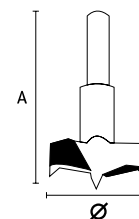

- Tipo Forstner | Type Forstner | Tipo Forstner
- Aço HSS | HSS steel | Acero HSS
- Para madeira compensada e madeira maciça | For plywood and solid wood | Para madera contrachapada y madera maciza
- Widea com parte de aço de alta dureza | Widea with steel part of high hardness | Widea con parte de acero de alta dureza
- Haste cilíndrica | Cylindrical Rod | Vástago cilíndrico

Jogo de fresa para madeira

Wood cutter set | Juego de fresa para madera



7044055	DIMENSÕES SIZE TAMAÑO (MM)		20	1
	A	B		
	10	87		
	15	87		
	20	87		
	25	87		
	35	87		



5
peças
parts | piezas

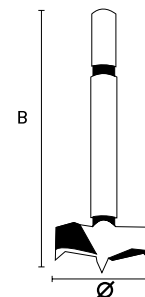

- Aço HSS | HSS steel | Acero HSS

Jogo de Lima rotativa

Rotating File Set | Juego de Lima rotativa



704999	200	25



5
peças
parts | piezas

- Para desbaste / acabamento | For roughing / finishing | Para desbaste / acabado
- Ponta Widea/metal duro | Wide / hard metal tip | Puntera Widea / metal duro
- Para madeira | For wood | Para madera

Broca bailarina

Drill for wood | Broca para madera



704979	155	210	60	6

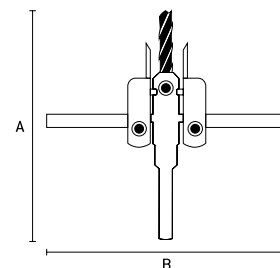
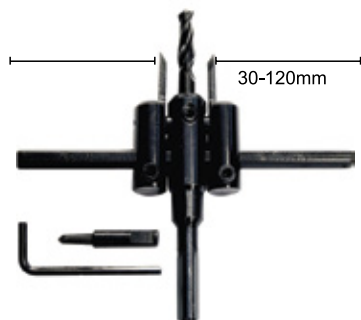

- Ajustável 30 - 120 mm Ø | Adjustable 30 - 120 mm Ø | Ajustable 30 - 120 mm Ø
- Excelente para fazer furos em madeira, gesso, plásticos, borrachas | Excellent for drilling holes in wood, plaster, plastics, rubbers | Excelente para hacer agujeros en madera, yeso, plásticos, gomas
- Corte de até 250 mm | Cutting up to 250 mm | Corte de hasta 250 mm
- Corte na profundidade de 25 mm

Jogo serra copo para madeira

Hole saw set for wood | Juego Sierra de agujero para madera



antigo	novo	DIMENSÕES SIZE TAMAÑO (MM)		Quant. Min.
		A	Ø	
70450	7045055	25,4	26 - 63	6
70452	7045255	50,8	26 - 63	6

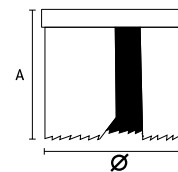

- Aço especial | Special steel | Acero especial
- Indicada para madeira, aglomerado e MDF | Suitable for wood, agglomerate and MDF | Indicada para madeira, aglomerado y MDF
- Possui suporte e broca guia | It has support and guide drill | Tiene soporte y broca guía
- Composição: 07 peças | Composition: 07 pieces | Composición: 07 piezas: Ø 26 - 32 - 38 - 44 - 50 - 56 - 63 mm
- Embalagem: caixa | Packing: Box | Embalaje: Caja

Jogo serra copo para madeira

Hole saw set for wood | Juego Sierra de agujero para madera



	DIMENSÕES SIZE TAMAÑO (MM)		Quant. Min.
	A	Ø	
7047159	25,4	64-127	1

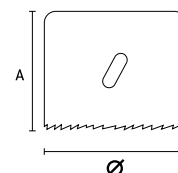

- Indicada para madeira, compensado, aglomerado e MDF | Suitable for wood, plywood, chipboard and MDF | Indicada para madeira, contrachapada, aglomerado y MDF
- 05 serras copo: cup saws: | sierras de vidrio: Ø 64, 76, 89, 102 e 127 mm
- 01 suporte para serra copo e broca | 01 bracket with hole | 01 soporte con agujero
- 01 broca com haste triangular | 01 drill with triangular rod | 01 broca con vástago triangular
- 01 chave allen | 01 allen key | 01 llave allen
- Embalagem: Caixa plástica | Packing: Plastic box | Embalaje: Caja plástica

Jogo serra copo para madeira

Hole saw set for wood | Juego Sierra de agujero para madera



	DIMENSÕES SIZE TAMAÑO (MM)		Quant. Min.
	A	Ø	
704729	25,4	19-127	1

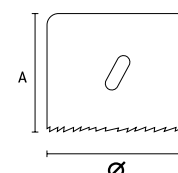

- Indicada para madeira, aglomerado e MDF | Suitable for wood, chipboard and MDF | Indicada para madeira, aglomerado y MDF
- 12 Serras Copo nas medidas: | 12 Saws Glass in measurements: | 12 Sierras Vaso en las medidas: Ø 19, 22, 29, 32, 38, 44, 51, 64, 76, 89, 102, 127 mm
- 01 suporte para serra copo de até 30 mm | 01 soporte con agujero
- 01 broca com haste triangular para serras copo acima de 31 mm | 01 drill with triangular rod | 01 broca con vástago triangular
- 01 chave allen | 01 allen key | 01 llave allen
- Embalagem: Caixa plástica | Packing: Plastic box | Embalaje: Caja plástica

Jogo serra copo para madeira

Hole saw set for wood | Juego Sierra de agujero para madera



	DIMENSÕES SIZE TAMAÑO (MM)		Quant. Min.
	A	Ø	
704739	25,4	19-64	1

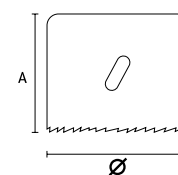

- Indicada para madeira, aglomerado e MDF | Suitable for wood, chipboard and MDF | Indicada para madeira, aglomerado y MDF
- 8 Serras copo: | 8 Cup Saws: | 8 Sierras de vaso: Ø 19, 22, 29, 32, 38, 44, 51 e 64mm
- 01 suporte com furo | 01 bracket with hole | 01 soporte con agujero
- 01 broca com haste triangular | 01 drill with triangular rod | 01 broca con vástago triangular
- 01 chave allen | 01 allen key | 01 llave allen
- Embalagem: Caixa plástica | Packing: Plastic box | Embalaje: Caja plástica

Broca bailarina para cerâmica

Drill for ceramics | Broca para cerâmica



7282155	DIMENSÕES SIZE TAMAÑO (MM)		60	12
	A	B		
	155	210		

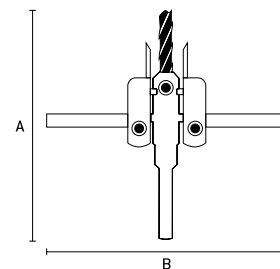

- Ajustável 30 - 120 mm Ø | Adjustable 30 - 120 mm Ø | Ajustable 30 - 120 mm Ø
- Excelente para fazer furos em azulejos e cerâmicas | Excellent for drilling holes in tiles and ceramics | Excelente para hacer agujeros en azulejos y cerâmicas
- Corte de até 260 mm | Cutting up to 260 mm | Corte de hasta 260 mm
- Corte na profundidade de 25 mm.

Jogo de broca para fechadura

Drill for wood | Broca para madeira

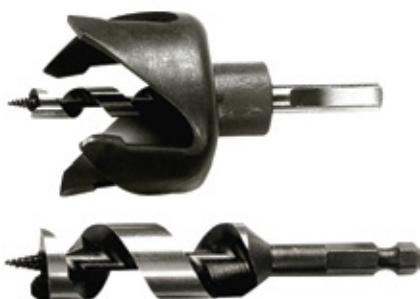

704919	704929	DIMENSÕES SIZE TAMAÑO (MM)		100	5
		A	B		
		22	48		
		22	55		

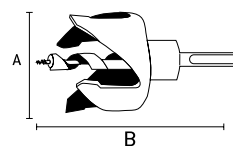

- Feito de aço carbono | Made of carbon steel | Hecho de acero al carbono
- Destina-se à instalação de fechaduras de porta | It is intended for the installation of door locks | Se destina a la instalación de cerraduras de puerta

Broca guia para serra copo - Wídea

Guide saw drill bit | Broca guia para Sierra de agujero



703389	Haste M22 x 250mm	DIMENSÕES SIZE TAMAÑO (MM)		30	1
		A	B		
		30	280		

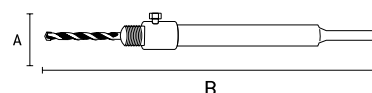

- Feito de aço carbono | Made of carbon steel | Hecho de acero al carbono
- Para utilização em conjunto com serra copo 703299 e 703319
- Encaixe SDS Plus

Serra copo - Wídea SDS Plus

Cup saw - Wídea | Sierra de agujero - Wídea



703299	m22x68	DIMENSÕES SIZE TAMAÑO (MM)		24	1
		A	B		
		130	20		
	m22x80	130	20		

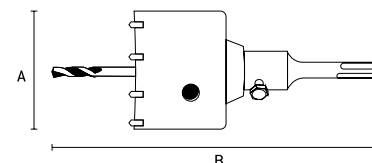

- Indicada para rompimento em alvenaria, fazer furos em paredes | Indicated for break in masonry, drill holes in walls | Indicada para rompimiento en albañilería, hacer agujeros en paredes
- Utilizada em martelo com encaixe SDS Plus | Used on a hammer with SDS Plus slot | Utilizada en martillo con encaje SDS Plus
- Haste com encaixe SDS Plus | SDS Plus Snap-On Rod | Vástago con ranura SDS Plus
- Embalagem: Caixa | Packing: Carton | Embalaje: Caja

Ponteiro SDS MAX

Pointer SDS MAX | Puntero SDS MAX



7034755	14x400mm	DIMENSÕES SIZE TAMAÑO (MM)		30	1
		A	B		



- Indicada para romper concreto, alvenaria e pedras | Indicated to break concrete, masonry and stones | Indicada para romper hormigón, albañilería y piedras
- Utilizada em martetele com encaixe SDS max | Used in hammer with SDS max | Utilizada en martillo con encaje SDS max
- Haste com encaixe SDS Max | SDS Max Docking Rod | Vástago con ranura SDS Max
- Proteção plástica total na broca | Full plastic protection on drill bit | Protección plástica total en la fresa
- Embalagem: Plástica para proteção completa da peça | Packaging: Plastic for complete protection of the part | Embalaje: Plástico para protección completa de la pieza

Ponteiro SDS PLUS

Pointer SDS PLUS | Puntero SDS PLUS



7034055	14x250mm	DIMENSÕES SIZE TAMAÑO (MM)		75	1
		A	B		



- Tipo SDS Plus | Type SDS Plus | Tipo SDS Plus
- Indicada para rompimento em alvenaria, fazer rasgos em paredes, remover pisos e azulejos | Indicated for break in masonry, make rips on walls, remove floors and tiles | Utilizada en martillo con encaje SDS max
- Utilizada em martetele com encaixe SDS Plus | Indicated for break in masonry, make rips on walls, remove floors and tiles... | Utilizada en martillo con encaje SDS max
- Haste com encaixe SDS Plus | SDS Plus Snap-On Rod | Vástago con ranura SDS Plus
- Proteção plástica total na broca | Full plastic protection on drill bit | Protección plástica total en la fresa
- Embalagem: Clip plástico | Packing: Plastic Clip | Packing: Plastic Clip

Talhadeira SDS MAX

Chisel SDS MAX | Cinzel SDS MAX



7034155	18x25x280mm	DIMENSÕES SIZE TAMAÑO (MM)		50	1
		A	B		
7034455	25x50x360mm	50	360	20	1



- Tipo SDS MAX | Type SDS MAX | Tipo SDS MAX
- Indicada para rompimento em alvenaria, fazer rasgos em paredes, remover pisos e azulejos | Indicated for break in masonry, make rips on walls, remove floors and tiles | Indicada para rompimiento en albañilería, hacer rasgos en paredes, quitar pisos y azulejos
- Utilizada em martetele com encaixe SDS MAX | Used on a hammer with SDS MAX slot | Utilizada en martillo con encaje SDS MAX
- Haste com encaixe SDS MAX | SDS MAX Snap-On Rod | Vástago con ranura SDS MAX
- Proteção plástica total na broca | Full plastic protection on drill bit | Protección plástica total en la fresa
- Embalagem: Clip plástico | Packing: Plastic Clip | Packing: Plastic Clip

Talhadeira SDS PLUS

Chisel SDS PLUS | Cinzel SDS PLUS



7031055	14x40x250mm	DIMENSÕES SIZE TAMAÑO (MM)		50	1
		A	B		
7032055	14x20x250mm	20	250	75	1



- Tipo SDS PLUS | Type SDS PLUS | Tipo SDS PLUS
- Indicada para rompimento em alvenaria, fazer rasgos em paredes, remover pisos e azulejos | Indicated for break in masonry, make rips on walls, remove floors and tiles | Indicada para rompimiento en albañilería, hacer rasgos en paredes, quitar pisos y azulejos
- Utilizada em martetele com encaixe SDS PLUS | Used on a hammer with SDS PLUS slot | Utilizada en martillo con encaje SDS PLUS
- Haste com encaixe SDS PLUS | SDS PLUS Snap-On Rod | Vástago con ranura SDS PLUS
- Proteção plástica total na broca | Full plastic protection on drill bit | Protección plástica total en la fresa
- Embalagem: Clip plástico | Packing: Plastic Clip | Packing: Plastic Clip



Adaptador para mandril SDS Plus

Adapter for mandrel | Adaptador para mandril



Código	Descrição	DIMENSÕES SIZE TAMAÑO (MM)		Quant. Min.	
		A	B		
703569	Para mandril de 1/2"	24	94	500	1
703579	Rosca M12	26	95	500	1

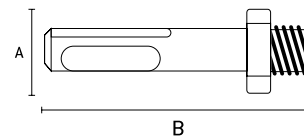

- Adaptador para encaixe SDS Plus | SDS Plus Dock Adapter | Adaptador para encaje SDS Plus

Broca de concreto SDS PLUS

Concrete drill bit SDS PLUS | Broca de concreto SDS PLUS



Ponta Em Cruz | Cross Tip | Punta En Cruz

Código	Tamanho	DIMENSÕES SIZE TAMAÑO (MM)		Quant. Min.	
		A	B		
7062655	6 x 110 mm	6	110	240	120
7062855	8 x 110 mm	8	110	240	120
7063055	10 x 110 mm	10	110	240	120
7063655	6 x 160 mm	6	160	240	120
7063855	8 x 160 mm	8	160	240	120
7064055	10 x 160 mm	10	160	240	120
7064255	12 x 160 mm	12	160	240	120
7064655	6 x 210 mm	6	210	120	60
7064855	8 x 210 mm	8	210	120	60
7065055	10 x 210 mm	10	210	120	60
7065255	12 x 210 mm	12	210	120	60

- Utilizadas em martelletes com encaixe tipo SDS - PLUS | Used in SDS - PLUS type jig hammers | Utilizadas en martelletes con acoplamiento tipo SDS - PLUS
- Indicada para concreto, concreto armado (com vergalhão) | Indicated for concrete, reinforced concrete (with rebar) | Indicada para hormigón, hormigón armado (con varilla)
- Videia em cruz | Cross-over | Véase en cruz
- Embalagem: Clip plástico | Packing: Plastic Clip | Embalaje: Clip plástico



Broca para concreto - Golden Line

Concrete drill - Golden line | Taladro para hormigón - Golden Line



Código	Tamanho	DIMENSÕES SIZE TAMAÑO (MM)		Quant. Min.	
		A	B		
708049	4 x 75 mm	4,0	75	500	250
708059	5 x 85 mm	5,0	85	500	250
708069	6 x 100 mm	6,0	100	500	250
708089	8 x 120 mm	8,0	120	200	100
708109	10 x 120 mm	10,0	120	200	100
708129	12 x 150 mm	12,0	150	200	100



- Ranhura especial que reduz o atrito e o aquecimento da broca | Special groove that reduces friction and heating of the drill bit | Ranura especial que reduce la fricción y el calentamiento de la broca
- Haste cilíndrica | Cylindrical Rod | Vástago cilíndrico
- Embalagem: Blister | Packing: Blister | Embalaje: Blister

Jogo de Broca para Concreto - Golden Line

Drill Set for Concrete - Golden line | Juego de Broca para Concreto - Golden Line

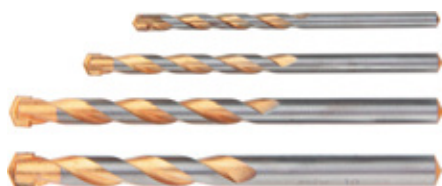

Código	Tamanho	DIMENSÕES SIZE TAMAÑO (MM)		Quant. Min.	
		A	B		
708259	5 x 85 mm	5	85	100	2
	6 x 120 mm	6	120		
	8 x 120 mm	8	120		
	10 x 120 mm	10	120		



- Ranhura especial que reduz o atrito e o aquecimento da broca | Special groove that reduces friction and heating of the drill bit | Ranura especial que reduce la fricción y el calentamiento de la broca
- Haste cilíndrica | Cylindrical Rod | Vástago cilíndrico
- Embalagem: Blister | Packing: Blister | Embalaje: Blister

Broca para Concreto
Concrete drill | Broca para concreto



Código	Dimensões	DIMENSÕES SIZE TAMAÑO (MM)		Quant. Min.	
		A	B		
708549	4 x 75 mm	4,0	75	400	100
708559	5 x 85 mm	5,0	85	400	100
708569	6 x 100 mm	6,0	100	400	100
708589	8 x 120 mm	8,0	120	400	100
708609	10 x 120 mm	10,0	120	400	100
708629	12 x 150 mm	12,0	150	400	100



- Acabamento Polido | Polished Finish | Acabado Pulido
- Haste cilíndrica | Cylindrical Rod | Vástago cilíndrico
- Norma DIN 8039 | Standard DIN 8039 | Norma DIN 8039
- Sulco fosfatizado | Phosphatized furrow | Surco fosfatizado
- Têmpera total no corpo | Total body hardening | Têmpera total en el cuerpo
- Ponta de carboneto de tungstênio (metal duro) | Tungsten carbide tip (carbide) | Extremidad de carburo de tungsteno (metal duro)
- Embalagem: Blister | Packing: Blister | Embalaje: Blister

Broca para Concreto SDS PLUS

Concrete drill SDS PLUS | Broca para concreto SDS PLUS



Código	Dimensões	DIMENSÕES SIZE TAMAÑO (MM)		Quant. Min.	
		A	B		
7100155	4 x 110 mm	4,0	110	240	20
7100255	5 x 110 mm	5,0	110	240	20
7100355	6 x 110 mm	6,0	110	240	20
7100555	8 x 110 mm	8,0	110	240	20
7101655	6 x 160 mm	6,0	160	240	20
7101855	8 x 160 mm	8,0	160	240	20
7102255	10 x 160 mm	10	160	240	20
7102355	12 x 160 mm	12	160	120	20
7102455	14 x 160 mm	14	160	120	20
710249	14 x 160 mm	14	160	120	20*
7102655	6 x 210 mm	6,0	210	120	20
7102755	8 x 210 mm	8,0	210	120	20
7102955	10 x 210 mm	10	210	120	20
7103155	12 x 210 mm	12	210	120	20
7103355	14 x 210 mm	14	210	120	20
7103855	8 x 300 mm	8,0	300	100	20
7103755	12 x 300 mm	12	300	120	20
7104055	14 x 300 mm	14	300	100	20
7103955	10 x 300 mm	10	300	100	20
7104155	16 x 300 mm	16	300	50	10
7104855	18 x 400 mm	18	400	50	10
7105055	20 x 400 mm	20	400	30	10
7105255	22 x 400 mm	22	400	30	10
7106455	14 x 600 mm	14	600	30	10
7091255	18 x 300 mm	18	300	50	10
7091455	20 x 300 mm	20	300	30	10
7091655	22 x 300 mm	22	300	30	10
7092255	26 x 300 mm	26	300	30	10
7094255	24 x 400 mm	24	400	20	10

- Encaixe SDS Plus | SDS Plus slot | Encaje SDS Plus
- Acabamento jateado | Blasting finish | Acabado Arenado
- Norma DIN 8039 | Standard DIN 8039 | Norma DIN 8039
- Proteção plástica total na broca | Full plastic protection on drill bit | Protección plástica total en la fresa
- Têmpera total no corpo | Total body hardening | Têmpera total en el cuerpo
- Ponta de carboneto de tungstênio (metal duro) | Tungsten carbide tip (carbide) | Extremidad de carburo de tungsteno (metal duro)
- Embalagem: Clip Plástico | Packing: Plastic Clip | Embalaje: Clip Plástico

Broca para Concreto SDS MAX

Concrete drill SDS MAX | Broca para concreto SDS MAX



Código	Dimensões	DIMENSÕES SIZE TAMAÑO (MM)			Quant. Min.	
		A	B	C		
7122355	12 x 340 mm	12	340	23	30	1
7122455	12 x 540 mm	12	540	23	20	1
7123655	14 x 340 mm	14	340	26	30	1
7123755	14 x 540 mm	14	540	26	20	1
7126155	30 x 370 mm	30	370	35	10	1
7126255	30 x 600 mm	30	600	35	10	1
7126655	16 x 340 mm	16	340	28	30	1
7126755	16 x 540 mm	16	540	28	12	1
7127155	18 x 340 mm	18	340	34	30	1
7127555	19 x 340 mm	19	340	34	15	1
7127655	19 x 540 mm	19	540	35	20	1
7128055	20 x 320 mm	20	320	25	30	1
7128155	20 x 520 mm	20	520	25	20	1
7128455	22 x 320 mm	22	320	22	30	1
7128555	22 x 520 mm	22	520	22	20	1
7128755	25 x 320 mm	25	320	27	20	1
7128855	25 x 520 mm	25	520	26	20	1
7129355	28 x 370 mm	28	370	32	20	1
7129455	28 x 570 mm	28	570	32	10	1
7129755	32 x 370 mm	32	370	35	20	1
7129855	32 x 570 mm	32	570	35	10	1

- Tipo de mandril de perfuração SDS MAX | Type of drill chuck SDS MAX | Tipo de mandril de perforación SDS MAX
- Tamanho da broca 16 mm | Drill size 16 mm | Tamaño de la broca 16 mm
- Comprimento da broca 400 mm | Drill length 400 mm | Longitud de la broca 400 mm

Broca HSS Professional Cobalto

HSS Professional Drill | Broca HSS Professional



BLISTER



Código	Descrição	DIMENSÕES SIZE TAMAÑO (MM)		Quant. Min.	
		A	B		
714029	2,0 mm - 2 pçs	2,0	80	500	10
714069	2,5 mm - 2 pçs	2,5	70	500	10
714119	3,0 mm - 2 pçs	3,0	75	500	10
714179	3,5 mm - 2 pçs	3,5	90	500	10
714199	4,0 mm - 1 pç	4,0	85	500	10
714229	4,5 mm - 1 pç	4,5	110	480	10
714269	5,0 mm - 1 pç	5,0	110	480	10
714299	5,5 mm - 1 pç	5,5	110	480	10
714369	6,0 mm - 1 pç	6,0	110	480	10
714399	6,5 mm - 1 pç	6,5	115	480	10
714479	7,0 mm - 1 pç	7,0	140	300	10
714539	7,5 mm - 1 pç	7,5	140	300	10
714589	8,0 mm - 1 pç	8,0	140	300	10
714699	9,0 mm - 1 pç	9,0	140	300	10
714729	10,0 mm - 1 pç	10,0	155	200	10
714829	12,0 mm - 1 pç	12,0	165	200	10



- Para corte de aço inox, aço temperado, ferro e latão | For cutting of stainless steel, tempered steel, iron and brass | Para corte de acero inoxidable, acero templado, hierro y latón
- Haste cilíndrica | Cylindrical Rod | Vástago cilíndrico
- Ângulo de afiação da ponta de 135° | 135° tip sharpening angle | Ángulo de afinación de la punta de 135°
- Norma DIN 338 | Standard DIN 338 | Norma DIN 338
- HSS com 5% de cobalto para aumentar a dureza e resistência ao calor do produto | HSS with 5% cobalt to increase the hardness and heat resistance of the product | HSS con un 5% de cobalto para aumentar la dureza y resistencia al calor del producto
- Adequada para uso industrial | Suitable for industrial use | Adecuada para uso industrial
- Embalagem: blister | Packing: blister | Embalaje: blister

Broca HSS Professional Aço Rápido

HSS Professional Drill | Broca HSS Professional



Código	Descrição	DIMENSÕES SIZE TAMAÑO (MM)		Quant. Min.	
		A	B		
7156055	1/16" x 70 mm - 10 pçs	1/16"	70	400	10
7156155	5/64" x 70 mm - 10 pçs	5/64"	70	400	10
7156255	3/32" x 70 mm - 10 pçs	3/32"	70	400	10
7156355	7/64" x 70 mm - 10 pçs	7/64"	70	400	10
7156455	1/8" x 80 mm - 10 pçs	1/8"	80	400	10
7156555	9/64" x 85 mm - 10 pçs	9/64"	85	400	10
7156655	5/32" x 85 mm - 10 pçs	5/32"	85	400	10
7156755	11/64" x 110 mm - 10 pçs	11/64"	110	240	10
7156855	3/16" x 110 mm - 10 pçs	3/16"	110	240	10
7156955	13/64" x 110 mm - 10 pçs	13/64"	110	240	10
7157055	7/32" x 110 mm - 10 pçs	7/32"	110	240	10
7157155	1/4" x 120 mm - 10 pçs	1/4"	120	200	10
7157255	5/16" x 140 mm - 10 pçs	5/16"	140	120	10
7157455	3/8" x 160 mm - 10 pçs	3/8"	160	60	10
7157555	7/16" x 155 mm - 10 pçs	7/16"	155	60	5
7157655	1/2" x 155 mm - 10 pçs	1/2"	155	60	5



- Para metais ferrosos e não ferrosos | For ferrous and non-ferrous metals | Para metales ferrosos y no ferrosos
- Haste cilíndrica | Cylindrical Rod | Vástago cilíndrico
- Norma DIN 338 | Standard DIN 338 | Norma DIN 338
- Ângulo de afiação da ponta de 135° | 135° tip sharpening angle | Ángulo de afinación de la punta de 135°
- Para aumento da vida útil do produto é recomendado a utilização de fluido / óleo de corte para lubrificação e resfriamento | For increased product life it is recommended to use cutting fluid / oil for lubrication and cooling | Para el aumento de la vida útil del producto se recomienda el uso de fluidos / aceite de corte para la lubricación y el enfriamiento

Broca para Fibrocimento e Mourão



Código	Dimensões	DIMENSÕES SIZE TAMAÑO (MM)		Quant. Min.
		A	B	
7080155	1/4" x 250 MM	6	250	60
7080255	9/32" x 250 MM	7	250	60
7080355	5/16" x 280 MM	8	280	60
7080455	1/2" x 400 MM	13	400	60
7080555	9/16" x 440 MM	14	440	60
7080655	5/8" x 480 MM	16	480	60

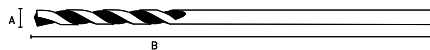

Broca HSS Standard

HSS Standard Drill | Broca HSS Estándar



HRC
62-65



- Polida | Polished | Pulido
- Para metais ferrosos e não ferrosos | For ferrous and non-ferrous metals | Para metales ferrosos y no ferrosos
- Haste cilíndrica | Cylindrical Rod | Vástago cilíndrico
- Ângulo de afiação da ponta de 135° | 135° tip sharpening angle | Ángulo de afinación de la punta de 135°
- Norma DIN 338 | Standard DIN 338 | Norma DIN 338
- Para aumento da vida útil do produto é recomendado a utilização de fluido / óleo de corte para lubrificação e resfriamento | For increased product life it is recommended to use cutting fluid / oil for lubrication and cooling | Para el aumento de la vida útil del producto se recomienda el uso de fluidos / aceite de corte para la lubricación y el enfriamiento

Código	Dimensões	DIMENSÕES SIZE TAMAÑO (MM)		Quant. Min.
		A	B	
715109	1,0 x 70 mm - 10 pçs	1,0	70	10
715159	1,5 x 70 mm - 10 pçs	1,5	70	10
715209	2,0 x 70 mm - 10 pçs	2,0	80	10
715259	2,5 x 70 mm - 10 pçs	2,5	70	10
715309	3,0 x 75 mm - 10 pçs	3,0	75	10
715359	3,5 x 90 mm - 10 pçs	3,5	90	10
715409	4,0 x 85 mm - 10 pçs	4,0	85	10
715459	4,5 x 110 mm - 10 pçs	4,5	110	10
715509	5,0 x 110 mm - 10 pçs	5,0	110	10
715559	5,5 x 110 mm - 10 pçs	5,5	110	10
715609	6,0 x 110 mm - 10 pçs	6,0	110	10
715659	6,5 x 115 mm - 10 pçs	6,5	115	10
715709	7,0 x 140 mm - 10 pçs	7,0	140	5
715759	7,5 x 140 mm - 10 pçs	7,5	140	10
715809	8,0 x 140 mm - 10 pçs	8,0	140	10
715859	8,5 x 140 mm - 10 pçs	8,5	140	10
715909	9,0 x 140 mm - 10 pçs	9,0	140	10
715959	9,5 x 155 mm - 10 pçs	9,5	155	5
715999	10 x 155 mm - 10 pçs	10,0	155	5
720109	11 x 170 mm - 5 pçs	11,0	170	10
720209	12 x 165 mm - 5 pçs	12,0	165	10
720309	13 x 170 mm - 5 pçs	13,0	170	5
720409	14 x 170 mm - 5 pçs	14,0	170	10
720509	15 x 200 mm - 5 pçs	15,0	200	5
720609	16 x 200 mm - 5 pçs	16,0	200	5
720709	17 x 220 mm - 5 pçs	17,0	220	2
720809	18 x 220 mm - 5 pçs	18,0	220	2
720909	19 x 210 mm - 5 pçs	19,0	210	2
720999	20 x 220 mm - 5 pçs	20,0	220	2

Broca HSS Profissional Nitreto de Titânio

HSS Professional Drill | Broca HSS Professional



HSS

BLISTER



- Polida/Nitreto de Titânio | Polished / Titanium Nitride | Polida / Nitruro de Titânio
- Para metais ferrosos e não ferrosos | For ferrous and non-ferrous metals | Para metales ferrosos y no ferrosos
- Ângulo de afiação da ponta de 135° | 135° tip sharpening angle | Ángulo de afinación de la punta de 135°
- Norma DIN 338 | Standard DIN 338 | Norma DIN 338
- Corpo de aço rápido (HSS) | Quick Steel Body (HSS) | Cuerpo de acero rápido (HSS)
- Revestida com nitreto de titânio para duplicar a vida útil do produto e qualidade de corte | Coated with titanium nitride to double product life and cut quality | Revestida con nitruro de titânio para duplicar la vida útil del producto y la calidad de corte
- Encaixe Sextavado | Fitting Sixth | Encaje Sextavado
- Embalagem: blister | Packing: blister | Embalaje: blister

Código	Dimensões	DIMENSÕES SIZE TAMAÑO (MM)		Quant. Min.
		A	B	
7172029	2,0 mm - 1 pç	2,0	80	150
7172529	2,5 mm - 1 pç	2,5	80	150
7173029	3,0 mm - 1 pç	3,0	80	150
7173529	3,5 mm - 1 pç	3,5	80	150
7174029	4,0 mm - 1 pç	4,0	80	150
7174529	4,5 mm - 1 pç	4,5	80	150
7175029	5,0 mm - 1 pç	5,0	80	100
7175529	5,5 mm - 1 pç	5,5	80	100
7176029	6,0 mm - 1 pç	6,0	80	100
7176529	6,5 mm - 1 pç	6,5	80	100
7177529	7,0 mm - 1 pç	7,0	80	100
7177029	7,5 mm - 1 pç	7,5	80	100
7178029	8,0 mm - 1 pç	8,0	80	100
7178529	8,5 mm - 1 pç	8,5	180	100
7179029	9,0 mm - 1 pç	9,0	225	50
7179529	10,0 mm - 1 pç	10,0	225	50



Broca HSS Profissional Nitreto de Titânio

HSS Professional Drill | Broca HSS Professional



BLISTER



Código	Dimensões	DIMENSÕES SIZE TAMAÑO (MM)			Quant. Min.
		A	B	C	
7172009	2,0 mm - 1 pç	2,0	49	600	150
7172509	2,5 mm - 1 pç	2,5	57	600	150
7173009	3,0 mm - 1 pç	3,0	61	600	150
7173509	3,5 mm - 1 pç	3,5	70	600	150
7174009	4,0 mm - 1 pç	4,0	75	600	150
7174509	4,5 mm - 1 pç	4,5	80	600	150
7175009	5,0 mm - 1 pç	5,0	86	600	150
7175509	5,5 mm - 1 pç	5,5	93	600	150
7176009	6,0 mm - 1 pç	6,0	80	600	150
7176509	6,5 mm - 1 pç	6,5	80	600	100
7177009	7,0 mm - 1 pç	7,0	80	400	100
7177509	7,5 mm - 1 pç	7,5	80	400	100
7178009	8,0 mm - 1 pç	8,0	80	400	50
7179009	9,0 mm - 1 pç	9,0	225	200	10
7179509	10,0 mm - 1 pç	10,0	225	200	50
7179809	12,0 mm - 1 pç	12,0	225	200	50



- Polida/Nitreto de Titânio | Polished / Titanium Nitride | Polida / Nitruro de Titanio
- Para metais ferrosos e não ferrosos | For ferrous and non-ferrous metals | Para metales ferrosos y no ferrosos
- Haste cilíndrica | Cylindrical Rod | Vástago cilíndrico
- Ângulo de afiação da ponta de 135° | 135° tip sharpening angle | Ángulo de afinación de la punta de 135°
- Norma DIN 338 | Standard DIN 338 | Norma DIN 338
- Corpo de aço rápido (HSS) | Quick Steel Body (HSS) | Cuerpo de acero rápido (HSS)
- Revestida com nitreto de titânio para duplicar a vida útil do produto e qualidade de corte | Coated with titanium nitride to double product life and cut quality | Revestida con nitruro de titanio para duplicar la vida útil del producto y la calidad de corte
- Embalagem: blister | Packing: blister | Embalaje: blister

Broca HSS Profissional Industrial

HSS Professional Drill | Broca HSS Professional



Código	Dimensões	DIMENSÕES SIZE TAMAÑO (MM)			Quant. Min.	
		A	B	C		
7180055	1,0 x 40 mm - 2 pçs	51	180	6	500	125
7180155	1,5 x 40 mm - 2 pçs	51	180	6	500	125
7180355	2,0 x 49 mm - 2 pçs	51	180	7	500	125
7180455	2,5 x 57 mm - 2 pçs	51	180	7	500	125
7180655	3,0 x 60 mm - 2 pçs	50	225	10	500	125
7180855	3,5 x 70 mm - 2 pçs	51	180	7	500	125
7181055	4,0 x 75 mm - 1 pç	50	180	6	500	125
7181255	4,5 x 80 mm - 1 pç	51	180	7	480	120
7181455	5,0 x 86 mm - 1 pç	51	180	7	480	120
7181655	5,5 x 93 mm - 1 pç	51	180	7	480	120
7181855	6,0 x 93 mm - 1 pç	51	180	7	480	120
7181955	6,5 x 100 mm - 1 pç	51	180	8	480	120
7182255	7,0 x 109 mm - 1 pç	51	228	10	300	75
7182355	7,5 x 109 mm - 1 pç	50	225	9	300	75
7182655	8,0 x 117 mm - 1 pç	51	228	10	300	75
7182755	8,5 x 117 mm - 1 pç	51	228	10	300	75
7182855	9,0 x 125 mm - 1 pç	51	228	12	300	75
7182955	9,5 x 125 mm - 1 pç	51	228	12	200	50
7183055	10,0 x 133 mm - 1 pç	51	228	12	200	50
7183455	11,0 x 142 mm - 1 pç	51	228	14	200	50
7183655	12,0 x 151 mm - 1 pç	51	227	14	200	50
7183955	13,0 x 151 mm - 1 pç	51	228	17	180	45
7184155	14,0 x 160 mm - 1 pç	60	280	18	100	25
7184255	15,0 x 169 mm - 1 pç	60	280	18	100	25
7184355	16,0 x 178 mm - 1 pç	60	280	18	100	25
7184455	17,0 x 184 mm - 1 pç	60	280	22	100	25
7184555	18,0 x 191 mm - 1 pç	60	280	22	100	25
7184655	19,0 x 198 mm - 1 pç	60	280	22	100	25
7184755	20,0 x 205 mm - 1 pç	60	280	22	100	25
7186155	1/16" x 43 mm - 2 pçs	1	180	50	500	125
7186255	5/64" x 49 mm - 2 pçs	2	180	50	500	125
7186355	3/32" x 57 mm - 2 pçs	2	180	50	500	125
7186455	7/64" x 61 mm - 2 pçs	3	180	50	500	125
7186555	1/8" x 65 mm - 2 pçs	50	180	5	500	125
7186655	9/64" x 70 mm - 2 pç	50	180	5	500	125
7186755	5/32" x 75 mm - 1 pç	50	180	6	500	125
7186855	11/64" x 80 mm - 1 pç	4	180	60	480	120
7186955	3/16" x 86 mm - 1 pç	50	180	6	480	120
7187055	13/64" x 86 mm - 1 pç	5	180	60	480	120
7187155	7/32" x 93 mm - 1 pç	50	180	6	480	120
7187255	1/4" x 101 mm - 1 pç	50	180	7	480	120
7187355	5/16" x 117 mm - 1 pç	7	227	90	300	75
7187455	3/8" x 125 mm - 1 pç	9	227	110	200	50
7187555	7/16" x 142 mm - 1 pç	11	227	120	200	50
7187655	1/2" x 151 mm - 1 pç	50	227	16	180	45



- Polida | Polished | Pulido
- Para metais ferrosos e não ferrosos | For ferrous and non-ferrous metals | Para metales ferrosos y no ferrosos
- Haste cilíndrica | Cylindrical rod | Vástago cilíndrico
- Aço de alta qualidade P6M5 | Steel P6M5 | Acero P6M5

Jogo de brocas HSS Profissional Nitreto de Titânio

HSS Professional Drill | Broca HSS Professional



723839	DIMENSÕES SIZE TAMAÑO (MM)		80	10
	A	B		
	57	155		

AUTO SERVIÇO



5 peças
parts | piezas



DIMENSÕES SIZE TAMAÑO (MM)	
A	B
3 mm	57
4 mm	75
5 mm	93
6 mm	93
8 mm	117

- Polida/Nitreto de Titânio | Polished / Titanium Nitride | Polida / Nitruro de Titânio
- Para metais ferrosos e não ferrosos | For ferrous and non-ferrous metals | Para metales ferrosos y no ferrosos
- Haste cilíndrica | Cylindrical Rod | Vástago cilíndrico
- Revestida com nitreto de titânio para duplicar a vida útil do produto e qualidade de corte | Coated with titanium nitride to double product life and cut quality | Revestida con nitruro de titânio para duplicar la vida útil del producto y la calidad de corte
- Embalagem: Caixa plástico | Packing: Plastic Box | Embalaje: Caja plástico

Jogo de Brocas para metal Nitreto de Titânio

Set of Metal Drills | Juego de Brocas para metal



723869	DIMENSÕES SIZE TAMAÑO (MM)		50	10
	A	B		
	108	215		

AUTO SERVIÇO



13 peças
parts | piezas



DIMENSÕES SIZE TAMAÑO (MM)	
A	B
1,5 mm	48
2 mm	49
2,5 mm	57
3 mm	61
3,2 mm	70
3,5 mm	70
4 mm	75
4,5 mm	80
4,8 mm	80
5 mm	86
5,5 mm	93
6 mm	93
6,5 mm	101

- Polida/Nitreto de Titânio | Polished / Titanium Nitride | Polida / Nitruro de Titânio
- Para metais ferrosos e não ferrosos | For ferrous and non-ferrous metals | Para metales ferrosos y no ferrosos
- Haste cilíndrica | Cylindrical Rod | Vástago cilíndrico
- Revestida com nitreto de titânio para duplicar a vida útil do produto e qualidade de corte | Coated with titanium nitride to double product life and cut quality | Revestida con nitruro de titânio para duplicar la vida útil del producto y la calidad de corte
- Embalagem: Caixa plástico | Packing: Plastic Caixa | Embalaje: Caja plástico

Broca Escalonada HSS Nitreto de Titânio

HSS Stepper Drill | Broca Escalada HSS



Barcode	Dimensions	Box Qty	Min. Qty
723539	4-5-6-7-8-9-10-11-12mm	24	2
723569	4-6-8-10-12-14-16-18-20mm	24	2
723579	6-8-10-12-14-16-18-20-22-24-26-28-30mm	24	2
723589	9-12-15-18-21-24-27-30-33-36mm	24	2
723599	4-6-8-10-12-14-16-18-20-22-24-26-28-30-32mm	24	2



- Haste sextavada | Hexagon rod | Vástago hexagonal
- Alta precisão de furação | Hexagon rod | Vástago hexagonal

Suporte / haste de fixação para serra copo

Clamping bracket / stem for cup saw | Soporte / vástago de fijación para Sierra de agujero



Barcode	Dimensions	DIMENSÕES SIZE TAMAÑO (MM)		Box Qty	Min. Qty
		A	B		
724949	até 30mm	102	205	100	10
724969	acima de 31mm	103	215	60	10

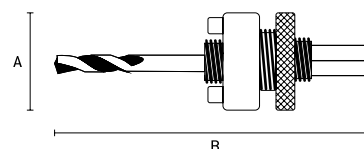

- Haste sextavada | Hexagon rod | Vástago hexagonal
- Indicada para fixar/sustentar a serra copo para realização do corte | Indicated for securing / holding the glass saw for cutting | Indicada para fijar / sostener la sierra vaso para realizar el corte
- Acompanha broca piloto (HSS) | Comes with pilot drill (HSS) | Acompaña broca piloto (HSS)
- Suporte em aço | Steel support | Soporte de acero
- Embalagem: Caixa | Packing: Carton | Embalaje: Caja

Serra copo aço rápido Bimetal / Easy Cut

Quick steel cup saw | Sierra de agujero de acero rápido

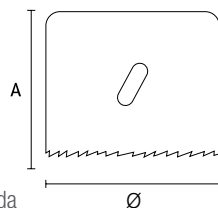

- 6 dentes por polegada | 6 teeth per inch | 6 dientes por pulgada
- Lâmina Bimetálica | Bimetallic Blade | Lámina Bimetálica
- Indicada para metais, plásticos, alumínio e inox | Suitable for metals | Indicada para metales
- Não acompanha haste/suporte | Does not include stem / support | No acompaña el vástago / soporte
- Dentes travados | Teeth locked | Dientes bloqueados
- Embalagem: Caixa | Packing: Carton | Embalaje: Caja

Barcode	Dimensions	DIMENSÕES SIZE TAMAÑO (MM)		Box Qty	Min. Qty
		A	Ø		
724149	14 mm	52	14	200	50
724169	16 mm	52	16	200	50
724199	19 mm	52	19	200	50
724229	22 mm	52	22	100	50
724259	25 mm	62	25	100	50
724299	29 mm	62	29	100	50
724329	32 mm	62	32	100	50
724339	33 mm	62	33	100	50
724359	35 mm	62	35	100	50
724389	38 mm	77	38	100	50
724409	40 mm	77	40	100	50
724419	41 mm	77	41	100	50
724449	44 mm	77	44	100	50
724489	48 mm	77	48	100	50
724519	51 mm	77	51	100	50
724549	54 mm	93	54	100	50
724579	57 mm	93	57	100	50
724609	60 mm	95	60	100	50
724649	64 mm	93	64	100	50
724679	67 mm	110	67	100	10
724689	68 mm	110	68	50	10
724709	70 mm	110	70	50	10
724739	73 mm	110	73	50	10
724769	76 mm	110	76	50	10
724789	78 mm	110	78	50	10
724809	80 mm	110	80	50	10
724839	83 mm	110	83	50	10
724869	86 mm	120	86	40	10
724899	89 mm	130	89	40	10
724919	102 mm	130	102	40	10
724939	105 mm	143	105	20	10
724959	114 mm	145	114	20	10
724979	121 mm	145	121	20	10
724989	127 mm	165	127	20	10
724999	140 mm	165	140	20	10

Jogo de Bits e Brocas

Set of Bits and Drills | Juego de Bits y Brocas



DIMENSÕES | SIZE | TAMAÑO (MM)

725779

A

B



Quant. Min.

20

1



300
peças
parts | piezas

Composição | Composition | composición:

- brocas de concreto | 5 pcs - 4 x 75 mm, 5 x 85 mm, 6 x 100 mm, 8 x 120 mm, 10 x 120 mm.
- brocas para metal | 7 pcs - 2 x 47 mm, 3 x 60 mm, 4 x 75 mm, 5 x 85 mm, 6 x 94 mm, 8 x 115 mm, 10 x 131 mm.
- brocas de madeira | 5 pcs - 4 x 75 mm, 5 x 85 mm, 6 x 95 mm, 8 x 114 mm, 10 x 120 mm.
- bits | 6 pcs - SL 4,5 x 25 mm, SL 6 x 25 mm, PH 1 x 25 mm, PH 2 x 25 mm, PZ 1 x 25 mm, PZ 2 x 25 mm.
- adaptador | 1 pc - 1/4" x 60 mm.
- buchas | 4 mm - 117 peças, 5 mm - 60 peças, 6 mm - 53 peças, 8 mm - 29 pcs e 10 mm - 17 peças.

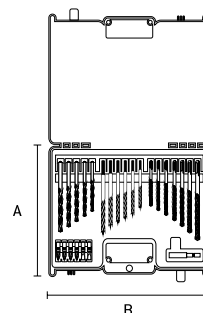

- Brocas para concreto, metal e madeira | Drills for concrete, metal and wood | Brocas para hormigón, metal y madera
- Adaptador magnético | Magnetic adapter | Adaptador magnético
- Bits | Bits | Bits
- Brocas para concerto de Wídea | Wídea concert drills | Brocas para concierto de Wídea
- Embalagem: Caixa plástico | Packing: Plastic Caixa | Embalaje: Caja plástico

Serra copo para vidro

Cup saw for glass | Sierra de agujero para vidrio



DIMENSÕES | SIZE | TAMAÑO (MM)

726149

14 mm

A

B



Quant. Min.

240

40

726169

16 mm

16

67

240

40

726189

18 mm

18

67

240

40

726209

20 mm

20

67

240

40

726229

22 mm

22

67

180

30

726259

25 mm

25

67

180

30

726289

28 mm

28

67

96

16

726309

30 mm

30

67

96

16

726329

32 mm

32

67

108

18



BLISTER



- Diamantada | Diamond | Diamante
- Haste triangular | Triangular rod | Vástago triangular
- **Atenção: sempre que possível utilizar esta serra copo com refrigeração para aumentar a performance do produto |**
Caution: Whenever possible use this cooled glass saw to increase product performance |
Atención: siempre que sea posible utilizar esta sierra vaso con refrigeración para aumentar el rendimiento del producto
- Embalagem: Blister | Packing: Blister | Embalaje: Blister

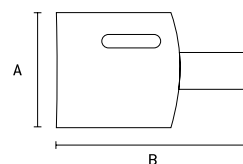

Broca para porcelanato

Porcelain drill bit | Broca para porcelana



DIMENSÕES | SIZE | TAMAÑO (MM)

728139

3 mm

A

B



Quant. Min.

500

100

728149

4 mm

4

80

500

100

728159

5 mm

5

80

500

100

728169

6 mm

6

80

500

100

728189

8 mm

8

80

500

100

728209

10 mm

10

80

500

100



BLISTER



- Indicada para furar porcelanato, cêramica e vidro | Hexagon rod | Vástago hexagonal
- Haste cilíndrica | Comes with pilot drill (HSS) | Acompaña broca piloto (HSS)
- Embalagem: Blister | Packing: Blister | Embalaje: Blister

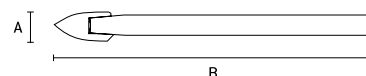

Serra copo para vidro e cerâmica

Cup Saw for glass and ceramics | Sierra de agujero para vidrio y cerámica



DIMENSÕES | SIZE | TAMAÑO (MM)

728045

7280455

4 mm

4

55

800

100

728065

7280655

6 mm

6

55

800

100

728085

7280855

8 mm

8

55

800

100

728105

7281055

10 mm

10

55

800

100

AUTO
SERVIÇO



- Diamantada | Diamond | Diamante
- Haste cilíndrica | Cilíndric rod | Vástago cilíndrica
- **Atenção: sempre que possível utilizar esta serra copo com refrigeração para aumentar a performance do produto |**
Caution: Whenever possible use this cooled glass saw to increase product performance |
Atención: siempre que sea posible utilizar esta sierra vaso con refrigeración para aumentar el rendimiento del producto
- Embalagem: Blister | Packing: Blister | Embalaje: Blister

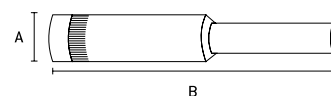

Serra copo para cerâmica e telha

Ceramic cup saw and tile | Sierra de agujero para cerâmica y teja



AUTO SERVIÇO



Barcode	Size	DIMENSÕES SIZE TAMAÑO (MM)		Box	Quant. Min.
		A	B		
728469	33 mm	33	36	100	2
728489	53 mm	53	55	100	2
728529	67 mm	67	76	50	2
728549	73 mm	73	75	50	2
728569	83 mm	83	85	50	2

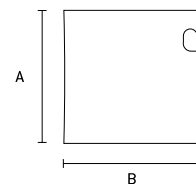

- Corpo em aço com serra diamantada | Steel body with diamond saw | Cuerpo en acero con sierra diamantada
- Indicada para cortar telhas, tijolos, cerâmicas, azulejos e vidros não temperados | Suitable for cutting tiles, bricks, ceramics, tiles and non-tempered glass | Vástago triangular
- Não acompanha haste / suporte | Does not include stem / support | No acompaña el vástago / soporte
- Embalagem: Caixa | Packing: Carton | Embalaje: Caja

Haste para suporte serra copo

Stem to support cup saw | Vástago para soporte Sierra de agujero



BLISTER



Barcode	Size	DIMENSÕES SIZE TAMAÑO (MM)		Box	Quant. Min.
		A	B		
728629	10 mm	10	200	125	25

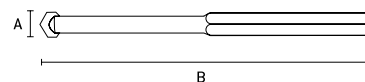

Suporte para serra copo

Cup saw holder | Soporte para Sierra de agujero



BLISTER



Barcode	Size	DIMENSÕES SIZE TAMAÑO (MM)		Box	Quant. Min.
		A	B		
728609	33 - 43 - 53 - 63 - 67 - 73 - 83 - 103 mm	10	160	50	5

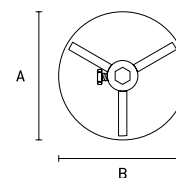

Jogo de serra copo para cerâmica e telha

Ceramic and tile glass saw set | Juego de Sierra de agujero para cerâmica y teja



Barcode	Size	DIMENSÕES SIZE TAMAÑO (MM)		Box	Quant. Min.
		A	B		
728429	33 mm	33	36	10	1
	53 mm	53	36		
	67 mm	67	36		
	73 mm	73	36		
	83 mm	83	36		

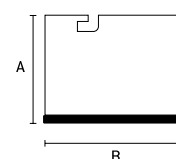

- Corpo metálico com serra diamantada | Metal body with diamond saw | Cuerpo metálico con sierra diamantada
- Indicada para cortar telhas, tijolos, cerâmicas e azulejos | Indicated for cutting tiles, bricks, ceramics and tiles | Indicada para cortar tejas, ladrillos, cerâmicas y azulejos
- Haste sextavada | Hexagon rod | Vástago hexagonal

Rebolos diamantados
Diamond wheels | Rebolos diamantados

AUTO
SERVIÇO



729059	segmentado duas linhas D115 mm	DIMENSÕES SIZE TAMAÑO (MM)		Quant. Min.
		Ø		
729059	segmentado duas linhas D115 mm	115	20	10
729099	turbo D115 mm	115	20	10
729139	turbo / segmentado D115 mm	115	20	10

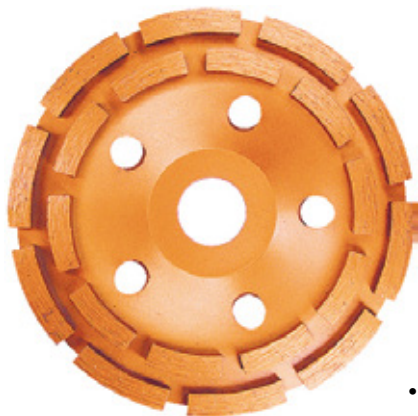

• 729059
segmentado duas linhas D115 |
segmented two lines D115 | segmentado dos líneas D115



• 729139
turbo / segmentado D115 mm |
turbo / segmented D115 mm | turbo / segmentado D115 mm

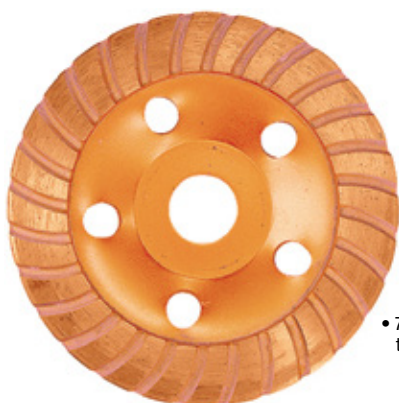

• 729099
turbo | turbo | turbo

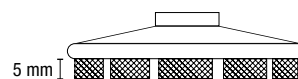
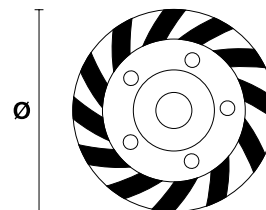
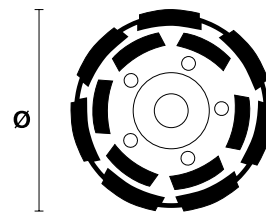

Rosca M14 |
Thread M14 |
Rosca M14



- Indicado para desbaste de mármore, granito, concreto, pedras, tijolo e para polimento | Indicado para desbaste de mármore, granito, concreto, piedras, afilado y pulido | Indicado para desbaste de mármore, granito, concreto, piedras, afilado y pulido
- Utilizado para esmerilhadeiras 4.1/2" - 115 mm | Used for grinders 4.1 / 2" - 115 mm | Utilizado para esmeriladoras 4.1 / 2" - 115 mm
- Rosca M14 | Thread M14 | Rosca M14
- Rotação máxima : 10.500 rpm | Maximum rotation: 10,500 rpm | Rotación máxima: 10.500 rpm
- Embalagem: Caixa | Packing: Carton | Embalaje: Caja
- Alto rendimento | High yield | Alto rendimiento

Discos de serra circular

Circular Saw Blades | Discos de sierra circular



Barcode	SKU	Description	DIMENSÕES SIZE TAMAÑO (MM)		Box	Quant. Min.
			A	B		
7322355	7,1/4" (185 mm)	24 dentes	20	185	50	5
7327855	7,1/4" (185 mm)	36 dentes	20	185	50	5
7326155	7,1/4" (185 mm)	24 dentes	22,23	185	50	5
7326255	7,1/4" (185 mm)	36 dentes	22,23	185	50	5
7326355	7,1/4" (185 mm)	48 dentes	22,23	185	50	5
7326455	7,1/4" (185 mm)	60 dentes	22,23	185	50	5
7326555	9,1/4" (230 mm)	24 dentes	25,4	230	25	5
7326655	9,1/4" (230 mm)	36 dentes	25,4	230	25	5
7326755	9,1/4" (230 mm)	48 dentes	25,4	230	25	5
7326855	9,1/4" (230 mm)	60 dentes	25,4	230	25	5
7324155	4,3/8" (110 mm)	24 dentes	22,23	110	100	10
7324255	4,3/8" (110 mm)	40 dentes	22,23	110	100	10
7327555	12" (305 mm)	36 dentes	30	305	12	1
7327755	12" (305 mm)	48 dentes	30	305	12	1
7328055	12" (305 mm)	60 dentes	30	305	12	1
7328755	12" (305 mm)	96 dentes	30	305	12	1
7329155	14" (350 mm)	48 dentes	30	350	10	1
7329355	14" (350 mm)	60 dentes	30	350	10	1
7329555	14" (350 mm)	96 dentes	30	350	10	1

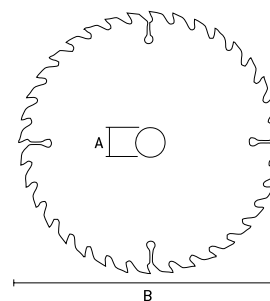

- Wídea | Wídea | Wídea
- Uso Profissional | Professional use | Uso profesional
- Não deixa lascas no canto | Does not leave splinters in the corner | No deja astillas en la esquina
- Com bucha de redução para 16 e 20 mm | With reduction sleeve for 16 and 20 mm | Con manguito de reducción de 16 - 20 mm

Discos de serra circular para Alumínio

Circular Saw Blades for Aluminum | Discos de sierra circular para Aluminio



Barcode	SKU	Description	DIMENSÕES SIZE TAMAÑO (MM)		Box	Quant. Min.
			A	B		
7338155	7,1/4" (185 mm) x 3/4" (20 mm)	60 dentes	20	185	50	5
7338255	10" (250 mm) x 1,1/4" (30 mm)	80 dentes	20	250	50	5
7338355	12" (300 mm) x 1,1/4" (30 mm)	96 dentes	22,23	300	50	5
7339255	12"	48 dentes	30	250	50	5
7339555	12"	60 dentes	30	300	50	5

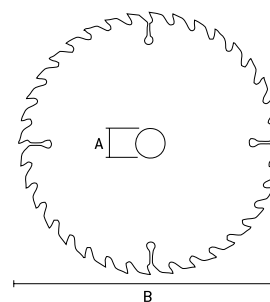

- Wídea | Wídea | Wídea
- Uso Profissional | Professional use | Uso profesional

Discos de corte diamantados Segmentado

Diamond Cutting Discs | Discos de corte diamantados



antigo	novo	CS	DIMENSÕES SIZE TAMARO (MM)		Quant. Min.
			A	B	
731055	7310555	115 x 2,0 x 22,2 mm	22,2	115	10
731115	7311155	180 x 2,4 x 22,2 mm	22,2	180	10

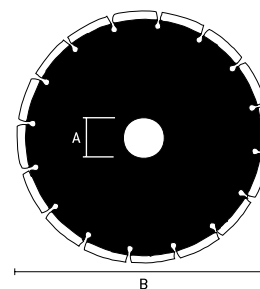

- Segmentado | Segmented | Segmentado
- Utilizado em serra mármore | Used in marble saw | Utilizado en sierra de mármol
- Indicado para mármore, granito, concreto e alvenaria | Suitable for marble, granite, concrete and masonry | Indicado para mármol, granito, hormigón y albañilería
- Corte a seco | Dry cut | Corte en seco
- **Atenção: os discos de corte seco, quando refrigerados proporcionam um melhor rendimento |**
Caution: Dry-cut discs, when cooled, provide better performance |
Atención: los discos de corte seco, cuando refrigerados proporcionan un mejor rendimiento

Discos de corte diamantados Linha Premium Segmentado

Diamond Cutting Discs | Discos de corte diamantados

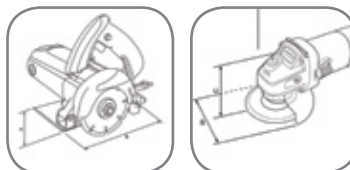

	CS	DIMENSÕES SIZE TAMARO (MM)		Quant. Min.
		A	B	
731729	115 x 2,0 x 22,2 mm	22,2	115	10
731779	230 x 2,4 x 22,2 mm	22,2	230	5

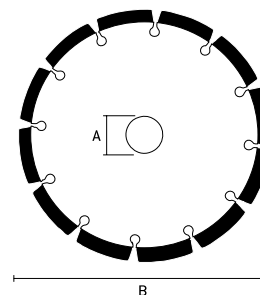

- Segmentado | Segmented | Segmentado
- Utilizado em serra mármore | Used in marble saw | Utilizado en sierra de mármol
- Utilização em esmerilhadeira disco de 115 mm | Use in 115 mm disk grinder | Uso en esmeriladora disco de 115 mm
- Indicado para mármore, granito, concreto e alvenaria | Suitable for marble, granite, concrete and masonry | Indicado para mármol, granito, hormigón y albañilería
- Corte a seco | Dry cut | Corte en seco
- **Atenção: os discos de corte seco, quando refrigerados proporcionam um melhor rendimento |**
Caution: Dry-cut discs, when cooled, provide better performance |
Atención: los discos de corte seco, cuando refrigerados proporcionan un mejor rendimiento

Discos de corte diamantados Segmentado

Diamond Cutting Discs | Discos de corte diamantados



	CS	DIMENSÕES SIZE TAMARO (MM)		Quant. Min.
		A	B	
731049	110 x 2,0 x 20,0 mm	20	110	10
731119	180 x 2,4 x 25,4 mm	25,4	180	10
731699	230 x 2,4 x 25,4 mm	25,4	230	1
731659	350 x 3,0 x 25,4 mm	25,4	350	1

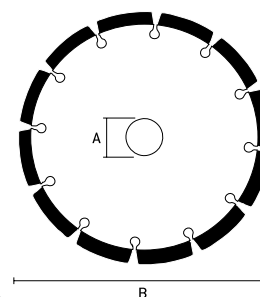

- Segmentado | Segmented | Segmentado
- Utilizado em serra mármore | Used in marble saw | Utilizado en sierra de mármol
- Dureza diferenciada na área de corte | Differential hardness in the cutting area | Dureza diferenciada en el área de corte
- Indicado para mármore, granito, concreto e alvenaria | Suitable for marble, granite, concrete and masonry | Indicado para mármol, granito, hormigón y albañilería
- Corte a seco | Dry cut | Corte en seco
- **Atenção: os discos de corte seco, quando refrigerados proporcionam um melhor rendimento |**
Caution: Dry-cut discs, when cooled, provide better performance |
Atención: los discos de corte seco, cuando refrigerados proporcionan un mejor rendimiento



Discos de corte diamantados Turbo

Diamond Cutting Discs | Discos de corte diamantados



antigo	novo	CS	DIMENSÕES SIZE TAMAÑO (MM)		Quant. Min.	
			A	B		
731175	7311755	115 x 2,0 x 22,2 mm	22,2	115	100	10
731235	7312355	180 x 2,4 x 22,2 mm	22,2	180	50	10

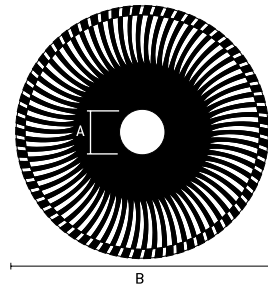
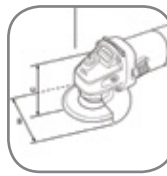

- Turbo | Turbo | Turbo
- Utilizado em serra mármore | Used in marble saw | Utilizado en sierra de mármol
- Indicado para cerâmica | Suitable for ceramics | Indicado para la cerámica
- NÃO indicado para porcelanato | NOT suitable for porcelain tile | NO indicado para porcelanato
- Corte a seco | Dry cut | Corte en seco
- **Atenção: os discos de corte seco, quando refrigerados proporcionam um melhor rendimento |**
Caution: Dry-cut discs, when cooled, provide better performance |
Atención: los discos de corte seco, cuando refrigerados proporcionan un mejor rendimiento

Discos de corte diamantados Turbo

Diamond Cutting Discs | Discos de corte diamantados



CS	DIMENSÕES SIZE TAMAÑO (MM)	Quant. Min.
731169	110 x 2,0 x 20,0 mm	10
731239	180 x 2,4 x 25,4 mm	10
731709	230 x 2,4 x 25,4 mm	10

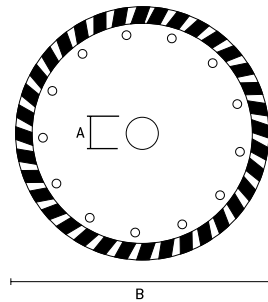

- Turbo | Turbo | Turbo
- Dureza diferenciada na área de corte | Differential hardness in the cutting area | Dureza diferenciada en el área de corte
- Utilizado em serra mármore | Used in marble saw | Utilizado en sierra de mármol
- Indicado para cerâmica | Suitable for ceramics | Indicado para la cerámica
- NÃO indicado para porcelanato | NOT suitable for porcelain tile | NO indicado para porcelanato
- Acompanha buchas de redução e anéis de adaptação | Comes with reduction bushings and adaptation rings | Acompaña los casquillos de reducción y los anillos de adaptación
- Corte a seco | Dry cut | Corte en seco
- **Atenção: os discos de corte seco, quando refrigerados proporcionam um melhor rendimento |**
Caution: Dry-cut discs, when cooled, provide better performance |
Atención: los discos de corte seco, cuando refrigerados proporcionan un mejor rendimiento

Discos de corte diamantados Linha Premium Turbo

Diamond Cutting Discs | Discos de corte diamantados



CS	DIMENSÕES SIZE TAMAÑO (MM)	Quant. Min.
731789	115 x 2,0 x 22,2 mm	10
731839	230 x 2,4 x 22,2 mm	5

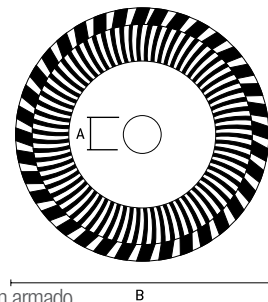
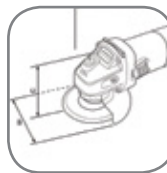

- Turbo | Turbo | Turbo
- Utilizado em serra mármore, concreto armado | Used in marble saw, reinforced concrete | Utilizado en sierra de mármol, hormigón armado
- NÃO indicado para porcelanato | NOT suitable for porcelain tile | NO indicado para porcelanato
- Acompanha buchas de redução e anéis de adaptação | Comes with reduction bushings and adaptation rings | Acompaña los casquillos de reducción y los anillos de adaptación
- Corte a seco | Dry cut | Corte en seco
- **Atenção: os discos de corte seco, quando refrigerados proporcionam um melhor rendimento |**
Caution: Dry-cut discs, when cooled, provide better performance |
Atención: los discos de corte seco, cuando refrigerados proporcionan un mejor rendimiento

Discos de corte diamantados Linha Premium Turbo/Segmentado

Diamond Cutting Discs | Discos de corte diamantados

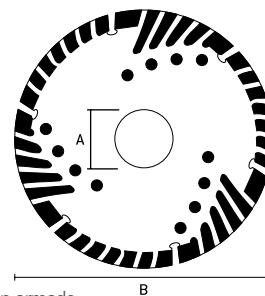
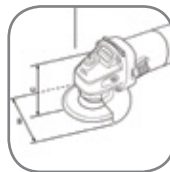

Código	Dimensões	DIMENSÕES SIZE TAMANHO (MM)		Quant. Min.
		A	B	
731529	115 x 2,0 x 22,2 mm	22,2	115	10
731559	180 x 2,4 x 22,2 mm	22,2	180	10

- Turbo | Turbo | Turbo
- Utilizado em serra mármore, concreto armado | Used in marble saw, reinforced concrete | Utilizado en sierra de mármol, hormigón armado
- NÃO indicado para porcelanato | NOT suitable for porcelain tile | NO indicado para porcelanato
- Acompanha buchas de redução e anéis de adaptação | Comes with reduction bushings and adaptation rings | Acompaña los casquillos de reducción y los anillos de adaptación
- Corte a seco | Dry cut | Corte en seco
- **Atenção: os discos de corte seco, quando refrigerados proporcionam um melhor rendimento |**
Caution: Dry-cut discs, when cooled, provide better performance |
Atención: los discos de corte seco, cuando refrigerados proporcionan un mejor rendimiento

Discos de corte diamantados Liso

Diamond Cutting Discs | Discos de corte diamantados

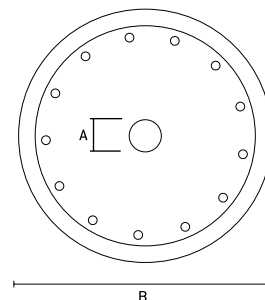

Código	Dimensões	DIMENSÕES SIZE TAMANHO (MM)		Quant. Min.
		A	B	
731389	110 x 2,0 x 20,0 mm	20	110	10
731499	180 x 2,4 x 25,4 mm	25,4	180	10
731929	230 x 2,4 x 25,4 mm	25,4	230	1

- Contínuo | Continuous | Continuo
- Dureza diferenciada na área de corte | Differential hardness in the cutting area | Dureza diferenciada en el área de corte
- Utilizado em serra mármore | Used in marble saw | Utilizado en sierra de mármol
- Indicado para mármore e granito | Suitable for marble and granite | Indicado para mármol y granito
- Acompanha buchas de redução e anéis de adaptação | Comes with reduction bushings and adaptation rings | Acompaña los casquillos de reducción y los anillos de adaptación
- Corte refrigerado | Refrigerated cutting | Corte refrigerado
- Embalagem: Blister | Packing: Blister | Embalaje: Blister

Discos de corte diamantados Linha Premium Liso

Diamond Cutting Discs | Discos de corte diamantados

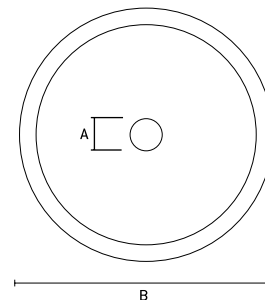
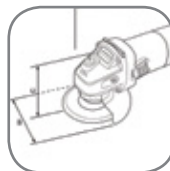

Código	Dimensões	DIMENSÕES SIZE TAMANHO (MM)		Quant. Min.
		A	B	
731849	115 x 2,0 x 22,2 mm	22,2	115	10
731919	230 x 2,4 x 22,2 mm	22,2	230	5

- Contínuo | Continuous | Continuo
- Utilizado em serra mármore | Used in marble saw | Utilizado en sierra de mármol
- Dureza diferenciada na área de corte | Differential hardness in the cutting area | Dureza diferenciada en el área de corte
- Indicado para mármore, granito, concreto e alvenaria | Suitable for marble, granite, concrete and masonry | Indicado para mármol, granito, hormigón y albañilería
- Corte a seco | Dry cut | Corte en seco
- **Atenção: os discos de corte seco, quando refrigerados proporcionam um melhor rendimento |**
Caution: Dry-cut discs, when cooled, provide better performance |
Atención: los discos de corte seco, cuando refrigerados proporcionan un mejor rendimiento



Discos de corte diamantados

Diamond Cutting Discs | Discos de corte diamantados



antigo	novo	CS	DIMENSÕES SIZE TAMAÑO (MM)		Quant. Min.
			A	B	
731395	7313955	115 x 2,0 x 22,2 mm	22,2	115	10
731475	7314755	180 x 2,4 x 22,2 mm	22,2	180	10

AUTO SERVIÇO

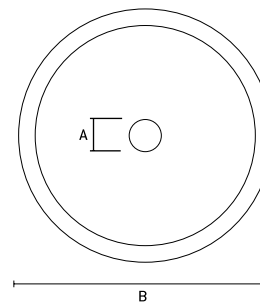

- Contínuo | Continuous | Continuo
- Dureza diferenciada na área de corte | Differential hardness in the cutting area | Dureza diferenciada en el área de corte
- Utilizado em serra mármore | Used in marble saw | Utilizado en sierra de mármol
- Indicado para mármore e granito | Suitable for marble and granite | Indicado para mármol y granito
- Acompanha buchas de redução e anéis de adaptação | Comes with reduction bushings and adaptation rings | Acompaña los casquillos de reducción y los anillos de adaptación
- Corte refrigerado | Refrigerated cutting | Corte refrigerado
- Embalagem: Blister | Packing: Blister | Embalaje: Blister

Adaptador para boina

Adapter for beret | Adaptador para boina



CS	CS	DIMENSÕES SIZE TAMAÑO (MM)		Quant. Min.
		A	B	
762909	rosca M14	6 8	115	6



BLISTER

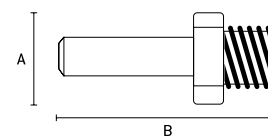
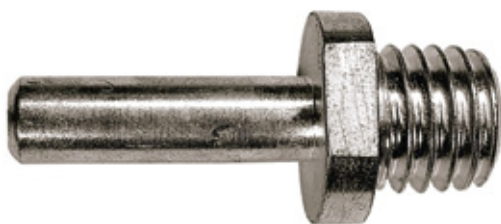

- Adaptador para a instalação de suporte de boina | Adapter for the installation of | Adaptador para la instalación de
- Feito em aço carbono | Made of carbon steel | Hecho en acero al carbono

Suporte de boina

Beret holder | Soporte de boina



CS	CS	DIMENSÕES SIZE TAMAÑO (MM)		Quant. Min.
		A	B	
762189	115 mm	130	115	2
762209	125 mm	140	125	2

AUTO SERVIÇO

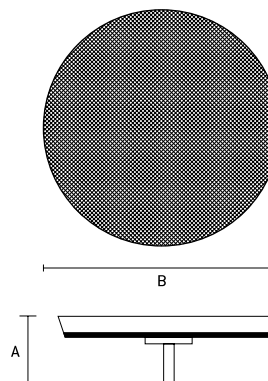

- Com velcro | With velcro | Con el velcro
- Para furadeira e maquinário elétrico | For drill and electric machinery | Para taladro y maquinaria eléctrica
- Embalagem: Blister | Packing: Blister | Embalaje: Blister

Discos de lixa com velcro

Sanding discs with velcro | Discos de lixa con velcro

AUTO
SERVIÇO



DIMENSÕES | SIZE | TAMAÑO (MM)



Quant. Min.

		Ø		
738009	grão 24	125	200	10
738019	grão 36	125	200	10
738029	grão 40	125	200	10
738039	grão 60	125	200	10
738049	grão 80	125	200	10
738059	grão 100	125	200	10
738069	grão 120	125	200	10
738079	grão 150	125	200	10
738089	grão 180	125	200	10
738099	grão 220	125	200	10

5
peças
parts | piezas

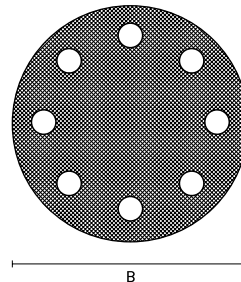

- Costado de fibra com velcro | Velcro fiber side | Costado de fibra con velcro
- Perfurado | Perforated | Perforado
- Utilizado em máquinas angulares rotativas de acionamento elétrico ou pneumático |
Used in rotary angular electric or pneumatic drive machines |
Utilizado en máquinas angulares rotativas de accionamiento eléctrico o neumático
- Aplicações em estruturas metálicas, indústria naval, fundições de metais ferrosos e indústria automobilística |
Applications in metal structures, shipbuilding, ferrous metal foundries and the automotive industry |
Aplicaciones en estructuras metálicas, industria naval, fundiciones de metales ferrosos e industria automovilística

Discos de lixa

Sanding discs | Discos de lixa

AUTO
SERVIÇO



DIMENSÕES | SIZE | TAMAÑO (MM)



Quant. Min.

		Ø		
738109	grão 24	115	200	10
738159	grão 40	115	200	10
738209	grão 60	115	200	10
738259	grão 80	115	200	10
738309	grão 24	125	200	10
738339	grão 36	125	200	10
738359	grão 40	125	200	10
738409	grão 60	125	200	10
738459	grão 80	125	200	10
738509	grão 100	125	200	10
738559	grão 120	125	200	10
738609	grão 150	125	200	10
738659	grão 180	125	200	10
738709	grão 220	125	200	10

10
peças
parts | piezas

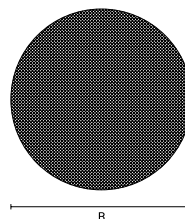

- Costado de fibra com velcro | Velcro fiber side | Costado de fibra con velcro
- Utilizado em máquinas angulares rotativas de acionamento elétrico ou pneumático |
Used in rotary angular electric or pneumatic drive machines |
Utilizado en máquinas angulares rotativas de accionamiento eléctrico o neumático
- Aplicações em estruturas metálicas, indústria naval, fundições de metais ferrosos e indústria automobilística |
Applications in metal structures, shipbuilding, ferrous metal foundries and the automotive industry |
Aplicaciones en estructuras metálicas, industria naval, fundiciones de metales ferrosos e industria automovilística

Rodas de lixa

Sandpaper wheels | Ruedas de lixa

AUTO
SERVIÇO



DIMENSÕES | SIZE | TAMAÑO (MM)



Quant. Min.

		A	B	C		
741109	grão 40	60	20	6	240	20
741129	grão 60	60	20	6	240	20
741149	grão 80	60	20	6	240	20
741209	grão 40	60	30	6	200	10
741229	grão 60	60	30	6	200	10
741249	grão 80	60	30	6	120	10
741409	grão 40	80	30	6	100	50
741429	grão 60	80	30	6	100	50
741449	grão 80	80	30	6	100	50
741509	grão 40	80	40	6	100	10
741529	grão 60	80	40	6	100	10
741549	grão 80	80	40	6	100	10

- Para furadeira | For drilling | Para taladro
- Com haste | With stem | Con barra
- Adaptável em lixadeiras para torno e furadeiras elétricas |
Adaptable in lathe grinders and electric drills | Adaptable en lijadoras para torno y taladros eléctricos
- Utilizada no desbaste e acabamento de superfícies planas, contornos e partes internas |
Used in the roughing and finishing of flat surfaces, contours and internal parts |
Utilizada en el desbaste y acabado de superficies planas, contornos y partes internas
- Indicado para aço, ferro, plástico e alumínio |
Suitable for steel, iron, plastic and aluminum | Indicado para acero, hierro, plástico y aluminio

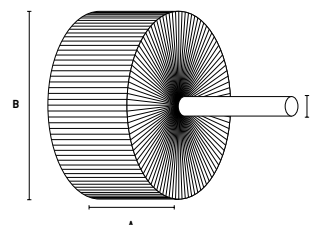

Discos de desbaste

Roughing discs | Discos de desbaste



	DIMENSÕES SIZE TAMAÑO (MM)			Quant. Min.
	A	B	C	
7376255	22,2	115	4,8	5
7376455	22,2	115	6,4	5
7377255	22,2	125	6	5
7379155	22,2	180	6,4	5

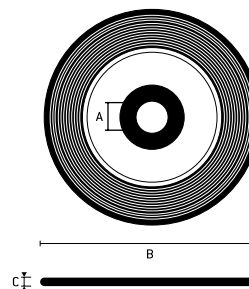

- Indicado para desbastes em metais ferrosos com esmerilhadeira angular | Indicated for slabs in ferrous metals with angle grinder | Indicado para desbaste en metales ferrosos con esmeriladora angular
- Alta durabilidade, qualidade e segurança | High durability, quality and safety | Alta durabilidad, calidad y seguridad

Discos de desbaste óxido de alumínio

Roughing discs | Discos de desbaste



		DIMENSÕES SIZE TAMAÑO (MM)		Quant. Min.
		A	B	
740269	grão 25	22	115	5
740279	grão 40	22	115	5
740289	grão 60	22	115	5
740299	grão 80	22	115	5
740319	grão 100	22	115	5
740329	grão 120	22	115	5

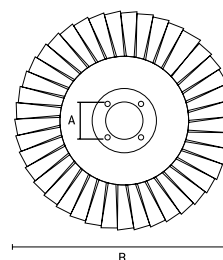

- Indicado para acabamento em aço inox, alumínio, metais ferrosos e não ferrosos, madeira e plástico | Indicated for finishing in stainless steel, aluminum, ferrous and non-ferrous metals, wood and plastic | Indicado para acabado en acero inoxidable, aluminio, metales ferrosos y no ferrosos, madera y plástico
- Utilizado em máquinas angulares rotativas de acionamento elétrico ou pneumático | Used in rotating angular machines of electric or pneumatic drive | Utilizado en máquinas angulares rotativas de accionamiento eléctrico o neumático
- Aplicações em estruturas metálicas, indústria naval, fundições de metais ferrosos e indústria automobilística | Applications in metal structures, shipbuilding, ferrous metal foundries and the automotive industry | Aplicaciones en estructuras metálicas, industria naval, fundiciones de metales ferrosos e industria automovilística

Discos de desbaste "FLAP" zircônio

Roughing discs "FLAP" zirconium | Discos de desbaste "FLAP" zirconio

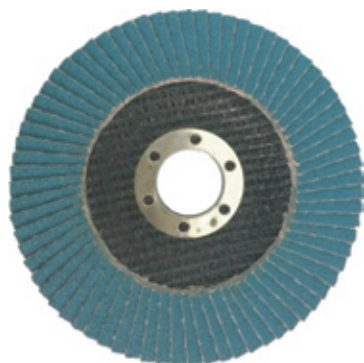

		DIMENSÕES SIZE TAMAÑO (MM)		Quant. Min.
		A	B	
7401555	grão 36	22	115	5
7401655	grão 40	22	115	5
7401755	grão 60	22	115	5
7401855	grão 80	22	115	5
7401955	grão 100	22	115	5
7402355	grão 120	22	115	5

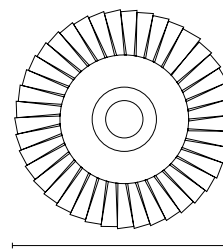

- Indicado para acabamento em aço inox, alumínio, metais ferrosos e não ferrosos, madeira e plástico | Indicated for finishing in stainless steel, aluminum, ferrous and non-ferrous metals, wood and plastic | Indicado para acabado en acero inoxidable, aluminio, metales ferrosos y no ferrosos, madera y plástico
- De Zircônio | Of Zirconium | De Zirconio

Disco de corte Inox/ Metal

Stainless Steel Cutting Disc/Metal | Disco de corte Inox/ Metal



Barcode	SKU	DIMENSÕES SIZE TAMAÑO (MM)			Box	Quant. Min.
		A	B	C		
7375255	115 x 1,0 x 22 mm	22	115	1,0	400	100
7375455	115 x 1,6 x 22 mm	22	115	1,6	400	100
7378155	180 x 1,6 x 22 mm	22	180	1,6	200	50

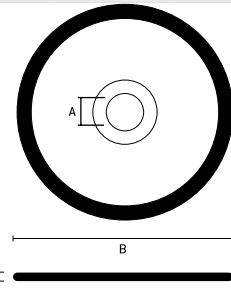

- **Reforçado com 2 telas** | Reinforced with 2 screens | Reforzado con 2 pantallas
- **Aplicação: eficaz em aço inox e metais ferrosos e não ferrosos** | Application: effective in stainless steel and ferrous and non-ferrous metals | Aplicación: eficaz en acero inoxidable y metales ferrosos y no ferrosos
- **Corte rápido e limpo** | Fast and clean cutting | Corte rápido y limpio
- **Não queima e não deixa manchas na peça** | Does not burn and does not leave stains on the part | No se quema y no deja manchas en la pieza
- **Proporciona menos esforço e aumenta a vida útil da máquina** | Provides less effort and increases machine life | Proporciona menos esfuerzo y aumenta la vida útil de la máquina

Disco de corte Metal

Stainless Steel Cutting Disc/Metal | Disco de corte Metal



Barcode	SKU	DIMENSÕES SIZE TAMAÑO (MM)			Box	Quant. Min.
		A	B	C		
7432655	115 x 1,0 x 22 mm	22	115	1,0	400	100
7432855	115 x 1,6 x 22 mm	22	115	1,6	400	100
7434755	180 x 1,6 x 22 mm	22	180	1,6	200	50

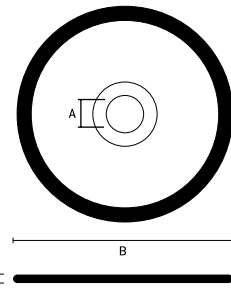

- **Metal** | Metal | Metal
- **Reforçado com 2 telas** | Reinforced with 2 screens | Reforzado con 2 pantallas
- **Aplicação: eficaz para corte de metais ferrosos em geral, ferro fundido e ferro fundido modular** | Application: effective for cutting ferrous metals in general, cast iron and cast iron modular | Aplicación: eficaz para corte de metales ferrosos en general, hierro fundido y hierro fundido modular
- **Dura muito mais do que as maiorias dos abrasivos existentes** | Lasts much longer than most existing abrasives | Dura mucho más que las mayorías de los abrasivos existentes.
- **Proporciona menor esforço ao operador alta produtividade** | Provides lower effort to operator high productivity | Proporciona menor esfuerzo al operador de alta productividad
- **Qualidade de corte: Rápido e limpo, com menos rebarbas** | Calidad de corte: Rápido y limpio, con menos rebabas

Disco de corte Inox/ Metal

Stainless Steel Cutting Disc/Metal | Disco de corte Inox/ Metal



Barcode	SKU	DIMENSÕES SIZE TAMAÑO (MM)			Box	Quant. Min.
		A	B	C		
7436155	115 x 1,0 x 22 mm	22	115	1,0	400	100
7436355	115 x 1,6 x 22 mm	22	115	1,6	400	100
7438255	180 x 1,6 x 22 mm	22	180	1,6	200	50

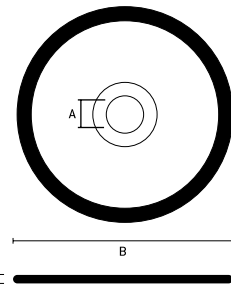

- **Pureza química de material, reforçado pelo 2 telas, sem queimar ou arranhar a peça, sem formação de rebarbas e descoloração** | Chemical purity of material, reinforced by 2 screens, without burning or scratching the part, without burr formation and discoloration | Pureza química de material, reforzado por las 2 pantallas, sin quemar o rayar la pieza, sin formación de rebabas y decoloración
- **Altíssima qualidade de corte para as obras mais exigentes** | Highest cutting quality for the most demanding works | Altísima calidad de corte para las obras más exigentes
- **Duração extremamente elevada para inox** | Extremely high lifetime for stainless steel | Duración extremadamente elevada para inox
- **Os produto atendem as exigências mais rigorosas de segurança** | Products meet the most stringent safety requirements | Los productos cumplen los requisitos más estrictos de seguridad



Escovas circulares Latonada com haste

Circular Brushes | Cepillos circulares



BLISTER



Código	Dimensão	DIMENSÕES SIZE TAMAÑO (MM)		Quant. Min.
		A	Quant. Min.	
744449	2" (50 mm)	50	240	24
744469	2.3/8" (60 mm)	60	120	12
744489	3" (75 mm)	75	120	12
744509	4" (100 mm)	100	120	12

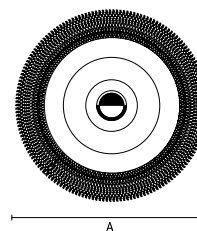

- Haste diâmetro 1/4" | Rod diameter 1/4 " | Vástago de diâmetro 1/4 "
- Aço carbono latonado | Brass carbon steel | Acero al carbono latonado
- Rotação máxima: 12500 rpm | Maximum rotation: 12500 rpm | Rotación máxima: 12500 rpm
- Embalagem: Blister | Packing: Blister | Embalaje: Blister

Escovas circulares onduladas

Circular Brushes | Cepillos circulares



AUTO SERVIÇO



Código	Dimensão	DIMENSÕES SIZE TAMAÑO (MM)		Quant. Min.
		A	Quant. Min.	
746089	4" (100 mm)	135	60	6
746169	5" (125 mm)	165	60	6

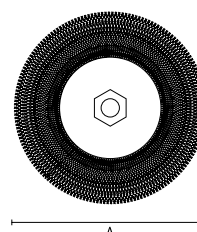

- Onduladas | Wavy | Corrugado
- Aço carbono polido | Polished carbon steel | Acero al carbono pulido
- Rotação máxima: 12500 rpm | Maximum rotation: 12500 rpm | Rotación máxima: 12500 rpm
- Rosca: M14 | Thread: M14 | Rosca: M14
- Embalagem: Caixa (Autosserviço) | Packaging: Cash (Self-service) | Embalaje: Caja (Autoservicio)

Escovas circulares torcidas

Circular Brushes | Cepillos circulares



AUTO SERVIÇO



Código	Dimensão	DIMENSÕES SIZE TAMAÑO (MM)		Quant. Min.
		A	Quant. Min.	
746309	4" (100 mm)	100	100	6
746329	5" (125 mm)	125	60	6
746349	6" (150 mm)	150	40	2
746369	7" (175 mm)	175	20	2
746389	8" (200 mm)	200	20	2

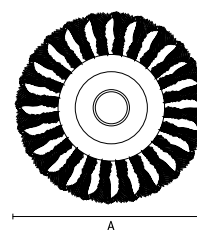

- Torcidas | Wavy | Corrugado
- Aço carbono polido | Polished carbon steel | Acero al carbono pulido
- Rotação máxima: 12500 rpm | Maximum rotation: 12500 rpm | Rotación máxima: 12500 rpm
- Furo: 7/8" (22mm) | Bore: 7/8 "(22mm) | Agujero: 7/8 "(22mm)
- Embalagem: Caixa (Autosserviço) | Packaging: Cash (Self-service) | Embalaje: Caja (Autoservicio)

Escovas circulares latonadas

Circular Brushes | Cepillos circulares



AUTO SERVIÇO



Código	Dimensão	DIMENSÕES SIZE TAMAÑO (MM)		Quant. Min.
		A	Quant. Min.	
746489	4" (100 mm)	100	100	10
746649	6" (150 mm)	150	60	6
746669	7" (175 mm)	175	40	4

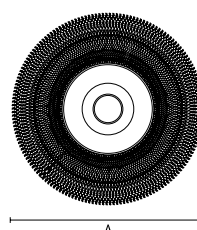

- Onduladas | Wavy | Corrugado
- Aço carbono latonado | Brass carbon steel | Acero al carbono latonado
- Rotação máxima: 4500 rpm | Maximum rotation: 4500 rpm | Rotación máxima: 4500 rpm
- Furo: 7/8" (22mm) | Bore: 7/8 "(22mm) | Agujero: 7/8 "(22mm)
- Embalagem: Caixa (Autosserviço) | Packaging: Cash (Self-service) | Embalaje: Caja (Autoservicio)

Escovas tipo copo torcidas com haste

Cup Brushes | Cepillos tipo vaso



BLISTER



Barcode	SKU	DIMENSÕES SIZE TAMAÑO (MM)		Box	Quant. Min.
		A	B		
744689	2.1/2" (65 mm)	65	130	120	12
744709	3" (75 mm)	75	140	120	12

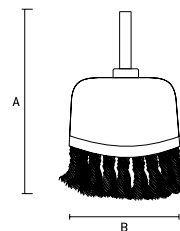

- Torcidas | Wavy | Corrugado
- Aço carbono polido | Polished carbon steel | Acero al carbono pulido
- Haste diâmetro 1/4" | Rod diameter 1/4" | Vástago de diâmetro 1/4"
- Embalagem: Caixa (Autosserviço) | Packaging: Cash (Self-service) | Embalaje: Caja (Autoservicio)

Escovas tipo copo latonadas com haste

Cup Brushes | Cepillos tipo vaso



BLISTER



Barcode	SKU	DIMENSÕES SIZE TAMAÑO (MM)		Box	Quant. Min.
		A	B		
744759	2" (50 mm)	50	115	240	12
744789	3" (75 mm)	75	140	120	12

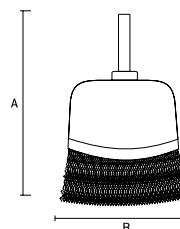

- Aço carbono latonado | Brass carbon steel | Acero al carbono latonado
- Haste diâmetro 1/4" | Rod diameter 1/4" | Vástago de diâmetro 1/4"
- Embalagem: Blister | Packing: Blister | Embalaje: Blister

Escovas tipo copo latonadas com rosca

Cup Brushes | Cepillos tipo vaso



AUTO SERVIÇO



Barcode	SKU	DIMENSÕES SIZE TAMAÑO (MM)		Box	Quant. Min.
		A	B		
746049	3" (75 mm)	75	110	100	6
746059	4" (100 mm)	100	135	60	6
746069	5" (125 mm)	125	160	30	3

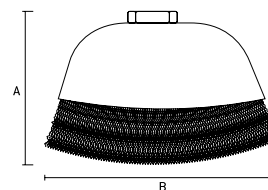

- Onduladas | Wavy | Corrugado
- Aço carbono latonado | Brass carbon steel | Acero al carbono latonado
- Rotação máxima: 10000 rpm | Maximum rotation: 10000 rpm | Rotación máxima: 10000 rpm
- Rosca: M14 | Thread: M14 | Rosca: M14
- Embalagem: Caixa (Autosserviço) | Packaging: Cash (Self-service) | Embalaje: Caja (Autoservicio)

Escovas tipo copo torcidas com rosca

Cup Brushes | Cepillos tipo vaso



AUTO SERVIÇO



Barcode	SKU	DIMENSÕES SIZE TAMAÑO (MM)		Box	Quant. Min.
		A	B		
746209	2.1/2" (65 mm)	65	100	100	6
746249	3" (75 mm)	75	110	100	6
746289	4" (100 mm)	100	140	60	6
746299	6" (150 mm)	150	200	24	4

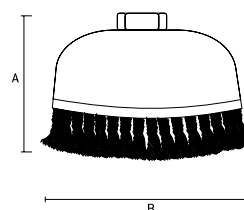

- Torcidas | Wavy | Corrugado
- Aço carbono polido | Polished carbon steel | Acero al carbono pulido
- Rotação máxima: 10000 rpm | Maximum rotation: 10000 rpm | Rotación máxima: 10000 rpm
- Rosca: M14 | Thread: M14 | Rosca: M14
- Embalagem: Caixa (Autosserviço) | Packaging: Cash (Self-service) | Embalaje: Caja (Autoservicio)

Jogo de escovas circulares onduladas com haste

Set of circular wavy brushes | Juego de cepillos circulares ondulados



Composição | Composition | Composición
 • 1 plana 4" (100 mm)
 • 1 tipo copo 3" (75 mm)

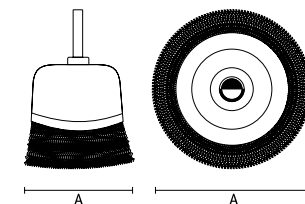

744809	PLANA FLAT TIPO COPO CUP TYPE	DIMENSÕES SIZE TAMAÑO (MM)		40	10
		A			
		100	75		

- Aço carbono latonado | Brass carbon steel | Acero al carbono latonado
- Haste diâmetro 1/4" | Rod diameter 1/4 " | Vástago de diâmetro 1/4 "
- Embalagem: Blister | Packing: Blister | Embalaje: Blister

Jogo de escovas

Set of brushes | Juego de cepillos



Composição | Composition | Composición
 • 1 plana 2" 1/2" (65 mm) com haste
 • 1 tipo copo 2 1/2" 65 mm com haste
 • 1 manual (120 mm)

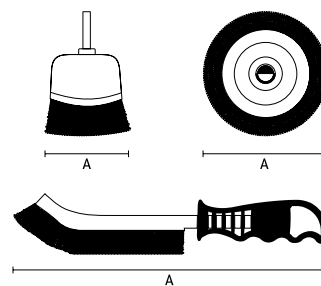

744849	PLANA FLAT TIPO COPO CUP TYPE MANUAL	DIMENSÕES SIZE TAMAÑO (MM)		40	10
		A			
		65	65		
			120		

- Aço carbono latonado | Brass carbon steel | Acero al carbono latonado
- Haste diâmetro 1/4" | Rod diameter 1/4 " | Vástago de diâmetro 1/4 "
- Embalagem: Blister | Packing: Blister | Embalaje: Blister

Jogo de escovas circulares onduladas

Set of circular wavy brushes | Juego de cepillos circulares ondulados



Composição | Composition | Composición
 1 plana 2" (50 mm)
 • 2 tipo copo 1" (25 mm) e 2" (50 mm)

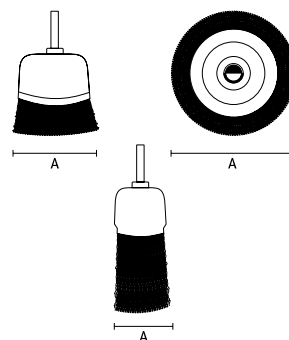

744869	PLANA FLAT TIPO COPO CUP TYPE TIPO COPO CUP TYPE	DIMENSÕES SIZE TAMAÑO (MM)		120	6
		A			
		50	50		
			25		

- Aço carbono latonado | Brass carbon steel | Acero al carbono latonado
- Haste diâmetro 1/4" | Rod diameter 1/4 " | Vástago de diâmetro 1/4 "
- Embalagem: Blister | Packing: Blister | Embalaje: Blister

Escova Manual

Hand brush | Cepillo Manual



748505	7485055	DIMENSÕES SIZE TAMAÑO (MM)		180	12
		A			
		120			

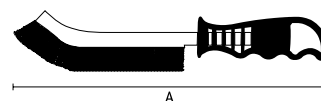

- Aço carbono latonado | Brass carbon steel | Acero al carbono latonado
- Pequena | Little | Pequeño

Escova pincel com haste

Steel Brush | Cepillo Pincel



7448555	DIMENSÕES SIZE TAMAÑO (MM)		240	6
	A			
	25			

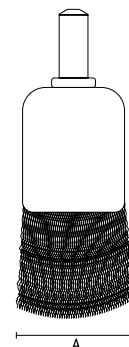

- Aço carbono | Carbon steel | Acero carbono
- Haste diâmetro 1/4" | Rod diameter 1/4 " | Vástago de diâmetro 1/4 "
- Embalagem: Blister | Packing: Blister | Embalaje: Blister

Escovas Manuais - Jogo

hand brushes - set | cepillos manuales - conjunto



748609	DIMENSÕES SIZE TAMAÑO (MM)		120	12
	A	B		
	100	250		

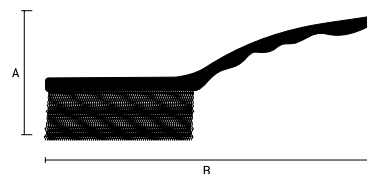

- Aço carbono | Carbon steel | Acero carbono
- Tamanho Grande | Big size | Tamaño grande
- Cabo Plástico | Plastic Cable | Mango de plástico
- Embalagem: Blister | Packing: Blister | Embalaje: Blister

Escovas Manuais - Jogo

hand brushes - set | cepillos manuales - conjunto



748639	DIMENSÕES SIZE TAMAÑO (MM)		120	6
	A	B		
	150	295		

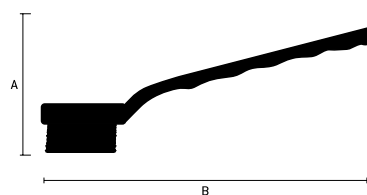

- Aço carbono | Carbon steel | Acero carbono
- Tamanho Pequeno | Small size | Tamaño pequeño
- Cabo Plástico | Plastic Cable | Mango de plástico
- Embalagem: Blister | Packing: Blister | Embalaje: Blister

Escova manual

Hand brush | Cepillo manual



antigo	novos	4 Fileiras	DIMENSÕES SIZE TAMAÑO (MM)		120	12
			A	B		
748665	7486655		40	280		
748675	7486755	5 Fileiras	40	270	120	12
748685	7486855	6 Fileiras	40	270	120	12

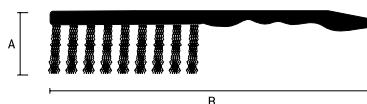

- Aço carbono | Carbon steel | Acero carbono
- Cabo de plástico | Plastic cable | Cable de plástico

Escova de aço

Steel brush | Cepillo de acero



antigo	novo	img	DIMENSÕES SIZE TAMAÑO (MM)			Quant. Min.	
			A	B			
748205	7482055	3 Fileiras	40	290	30	120	12
748225	7482255	4 Fileiras	40	290	40	120	12
748245	7482455	5 Fileiras	40	290	40	120	12
748265	7482655	6 Fileiras	40	290	40	120	12

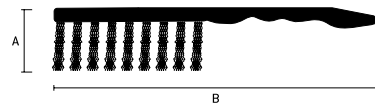

- Aço carbono | Carbon steel | Acero carbono
- Cabo de madeira | Wooden handle | Cable de madera

Jogo de Pontas montadas

Set of mounted tips | Juego de puntas montadas



img	Quant. Min.
760209	40

AUTO SERVIÇO



- Utilizado em retificadeiras | Used in rectifiers | Utilizado en rectificadoras
- Óxido de alumínio | Aluminum Oxide | Óxido de aluminio
- Indicada para retificar e desbastar pequenas peças com retificadeiras em ferramentaria, fundições, acabamento de furos | Indicated for grinding and thinning small parts with rectifiers in tooling, foundries, finishing of holes | Indicada para retificar y desbastar pequeñas piezas con rectificadoras en herramientas, fundiciones, acabado de agujeros
- Embalagem: Blister | Packing: Blister | Embalaje: Blister

Pedras de afiar

Sharpening stones | Piedras de afilado



img	DIMENSÕES SIZE TAMAÑO (MM)		Quant. Min.
	A	B	
7641555	50	150	1
7642055	51	200	1

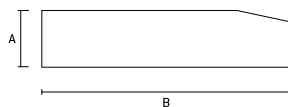

- Double side | Metal cable | Mango de metal
- Retângular | Rectangular | Rectangular
- Embalagem: Caixa | Packing: Box | Embalaje: Caja

Pedras de afiar

Sharpening stones | Piedras de afilado



img	DIMENSÕES SIZE TAMAÑO (MM)		Quant. Min.
	A	B	
7642555	41	230	5

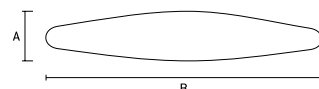

- Oval | Oval | Oval
- Embalagem: Caixa | Packing: Box | Embalaje: Caja

Lixa

Sandpaper | Papel de lija

AUTO SERVIÇO



Código	grão	DIMENSÕES SIZE TAMAÑO (MM)		Quant. Min.	
		A	B		
756069	grão 80	220	270	100	5*
756089	grão 100	220	270	100	5*
756109	grão 120	220	270	100	5*
756129	grão 180	220	270	200	5*
756149	grão 240	220	270	100	5*
756169	grão 320	220	270	100	5*
756189	grão 400	220	270	100	5*
756249	grão 1000	220	270	100	5*

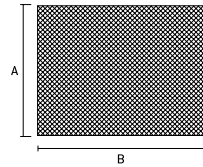

- Massa, Alvenaria e madeira | Spackling, Masonry and wood | Masa de carreras, Albañilería y madera
- Costado de papel | Paper side | Lado de papel
- Embalagem: Blister | Packing: Blister | Embalaje: Blister

Lixa

Sandpaper | Papel de lija

AUTO SERVIÇO

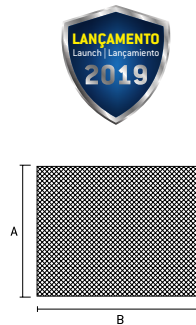

Código	grão	DIMENSÕES SIZE TAMAÑO (MM)		Quant. Min.	
		A	B		
7560455	grão 60	230	280	100	5
7560655	grão 80	230	280	100	5
7560855	grão 100	230	280	100	5
7561055	grão 120	230	280	100	5
7561255	grão 180	230	280	100	5
7561455	grão 240	230	280	100	5
7561655	grão 320	230	280	100	5
7561855	grão 400	230	280	100	5
7562055	grão 600	230	280	100	5
7562255	grão 800	230	280	100	5
7562455	grão 1000	230	280	100	5
7562855	grão 1500	230	280	100	5
7562955	grão 2000	230	280	100	5

- Metal | Metal | Metal
- Costado de papel | Paper side | Lado de papel
- Embalagem: Blister | Packing: Blister | Embalaje: Blister

Lixa

Sandpaper | Papel de lija

AUTO SERVIÇO



Código	grão	DIMENSÕES SIZE TAMAÑO (MM)		Quant. Min.	
		A	B		
7563355	grão 40	230	280	100	5
7563955	grão 60	230	280	100	5
7564155	grão 80	230	280	100	5
7564355	grão 100	230	280	100	5
7564555	grão 120	230	280	100	5

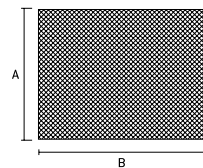

- Metal | Metal | Metal
- Costado de tecido | Fabric side | Lado de tejido
- Embalagem: Blister | Packing: Blister | Embalaje: Blister

Taco lixador

Sanding pad | Taco lijador



antigo	novo	DIMENSÕES SIZE TAMAÑO (MM)		Quant. Min.	
Código	Código	A	B		
758105	7581055	125	65	100	10

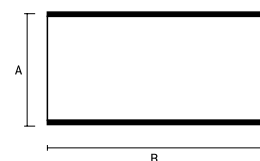

- Borracha | Rubber | Caucho
- Suporte para fixação de lixa | Support for fixing sandpaper | Soporte para fijación de lija

Macho

Male | Masculino



- Aço rápido | Fast Iron | Acero rápido
- Padrão internacional 4h | 4h international standard | Estándar internacional 4h
- Embalagem: Blister | Packing: Blister | Embalaje: Blister



766719	m4	DIMENSÕES SIZE TAMAÑO (MM)		500	125
		A	B		
766739	m5	0,8	153	500	125
766759	m6	1,0	153	500	125
766779	m8	1,25	160	500	125
766929	m10	1,5	160	500	125
766969	m12	1,75	160	500	125

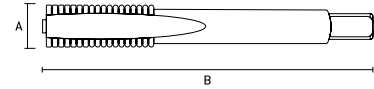

Vira macho

Male Tool | Macho Herramienta



- Tipo <T> | Type <T> | Tipo <T>
- Com catraca | With ratchet | Con carraca
- Cromado | Chrome plated | Cromo
- Embalagem: Blister | Packing: Blister | Embalaje: Blister



769059	M3-M8	DIMENSÕES SIZE TAMAÑO (MM)		120	5
		A	B		
769079	M5-M12	60	155	75	5

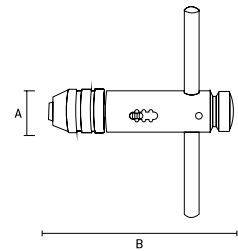

Vira macho

Male Tool | Macho Herramienta



- Reto | Straight | Directamente



7691255	M3-M12	DIMENSÕES SIZE TAMAÑO (MM)		150	5
		A	B		
7692055	M6-M20	35	315	36	4

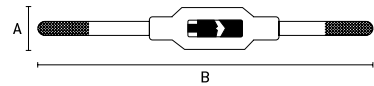

Cossinetes

Cossinetes | Dies



- Aço rápido com molibdênio | Rapid steel with molybdenum | Acero rápido con molibdeno
- Padrão internacional 4h | 4h international standard | Estándar internacional 4h
- Embalagem: Blister | Packing: Blister | Embalaje: Blister



770719	m4	DIMENSÕES SIZE TAMAÑO (MM)		500	25
		A	B		
770739	m5	0,8	70	500	125
770759	m6	1,0	70	500	125
770779	m8	1,25	70	500	125
770929	m10	1,5	70	500	125
770969	m12	1,75	70	200	50

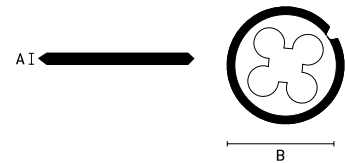

Porta Cossinetes

Door Cossinetes | Puerta Cossinetes



- Reto | Straight | Directamente



7742055	M3 - M6	DIMENSÕES SIZE TAMAÑO (MM)		200	5
		A	B		
7742555	M8	(25 mm)	210	120	5
7743855	M12 - M14	(38 mm)	293	48	4
7745055	M16 - M20	(45 mm)	250	32	4

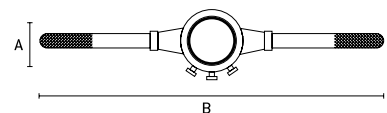

Jogo de tarraxas para canos metálicos

Set of metal pipe fittings | Juego de taras para tuberías metálicas



antigo
773305

novo
7733055

DIMENSÕES | SIZE | TAMAÑO (MM)
A B

3

Quant. Min.
1

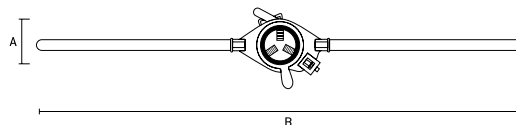

- Embalagem: Caixa | Packing: Box | Embalaje: Caja
- 1/2" - 3/4", 1" - 1 1/4", 1 1/4", 1 1/2" - 2"

Jogo de tarraxas para canos metálicos

Set of metal pipe fittings | Juego de taras para tuberías metálicas



antigo
773345

novo
7733455

maleta 360X470mm

2

Quant. Min.
1

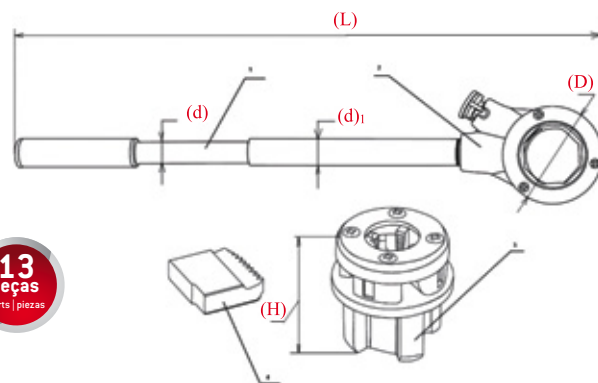

13
peças
parts | piezas

1-Cabo; 2-Corpo da base; 3-Mandril para cortadores; 4-Pestana de corte.

Codigo	Tamanho da Tarraxa	(H)	(D)	(d)	(d)1	(L)	Peso líquido, Gr.
773345	1/4"	65	80	22	25,5	530	538
	1/2"	68					650
	3/4"	67					622
	3/8"	63					830
	1"	72					1100
	1.1/4"	74					834

- Embalagem: Caixa | Packing: Box | Embalaje: Caja
- Rosca BSP | Screw Thread BSP | Tornillo BSP



JOGO DE TARRAXAS PARA CANOS METÁLICOS

Set of metal pipe fittings | Juego de taras para tuberías metálicas

USADO NA CONSTRUÇÃO CIVIL PARA FAZER ROSCAS EM TUBOS DE DIVERSOS DIÂMETROS.

FABRICADO EM AÇO CARBONO.



Estilete

Stiletto | Estilete



antigo	novo		DIMENSÕES SIZE TAMAÑO (MM)			
			A	B		Quant. Min.
78870	7887055	5 lâminas 2 lâminas	140 140	170 100	36	6

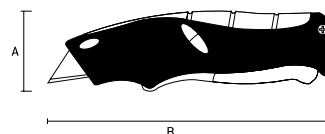

- Cabo três componentes | Cable with three components | Mango con tres componentes
- Mecanismo automático de recolhimento da lâmina | Automatic blade take-up mechanism | Mecanismo automático de recogida de la hoja
- Compartimento para lâminas | Blade compartment | Compartimiento para hojas
- Embalagem: Blister | Packing: Blister | Embalaje: Blister

Estiletos 170mm

Stiletto 170mm | Estiletos 170mm



antigo	novo		DIMENSÕES SIZE TAMAÑO (MM)			
			A	B		Quant. Min.
78882	7888255	2 lâminas	225	170	36	6

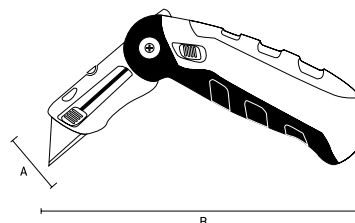

- Uso Profissional | Professional Use | Uso Profesional
- Corpo metálico | Metal body | Cuerpo metálico
- Guia lâmina aço carbono | Carbon Steel Blade Guide | Guía de hoja de acero al carbono
- Dobrável com lâmina trapezoidal | Folding with trapezoidal blade | Plegable con lâmina trapezoidal
- Botão de trava e destrava para fechamento do estilete | Lock and unlock button for stylus closure | Botón de bloqueo y desbloqueo para cerrar el estilete
- Compartimento com 2 lâminas | Compartment with 2 blades | Compartimiento con 2 cuchillas
- Indicado para corte de papel, papelão e outros materiais | Suitable for cutting paper, cardboard and other materials | Indicado para corte de papel, cartón y otros materiales

Estiletos 170mm

Stiletto 170mm | Estiletos 170mm



antigo	novo		DIMENSÕES SIZE TAMAÑO (MM)			
			A	B		Quant. Min.
78885	7888555	2 lâminas	90	170	72	12

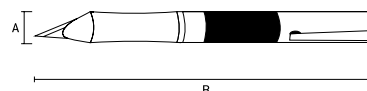

- Uso Profissional | Professional Use | Uso Profesional
- Corpo metálico | Metal body | Cuerpo metálico
- Sistema caneta de fechamento da lâmina | Blade closing pen system | Sistema pluma de cierre de la hoja
- Compartimento com 2 lâminas | Compartment with 2 blades | Compartimiento con 2 cuchillas
- Sistema de trava e destrava para fechamento do estilete | Lock and unlock system for stylus closure | Sistema de bloqueo y desbloqueo para cierre del estilete
- Indicado para corte de papel, papelão e outros materiais | Suitable for cutting paper, cardboard and other materials | Indicado para corte de papel, cartón y otros materiales

Lâmina para estilete

Stiletto blade | Láminas para estilete



antigo	novo		DIMENSÕES SIZE TAMAÑO (MM)			
			A	B		Quant. Min.
79376	7937655		20	150	144	6
79379			80	180	144	6*

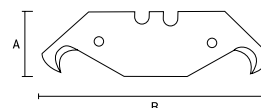
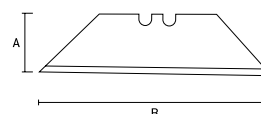

- Lâminas para estiletos e raspadores trapezoidais | Blades for styli and trapezoidal scrapers | Láminas para estiletos y raspadores trapezoidales
- Indicado para os produtos | Indicated for products | Indicado para los productos 78870, 78876, 78882, 789009, 789649, 789679
- Embalagem: Caixa Plástica | Packing: Plastic Box | Embalaje: Caja Plástica

Estiletos

Stiletto | Estilete

AUTO SERVIÇO



789149	DIMENSÕES SIZE TAMAÑO (MM)		144	Quant. Min.
	A	B		

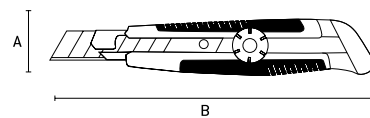

- **Usos Profissionais** | Professional Use | Uso Profesional
- **Corpo metálico** | Metal body | Cuerpo metálico
- **Lâmina retrátil** | Retractable blade | Láminas retráctiles
- **Botão de trava e destrava para lâmina** | Lock and unlock button for blade | Botón de bloqueo y desbloqueo para lámina
- **Embalagem: Blister** | Packing: Blister | Embalaje: Blister

Estiletos

Stiletto | Estilete

AUTO SERVIÇO



789189	DIMENSÕES SIZE TAMAÑO (MM)		288	24
	A	B		

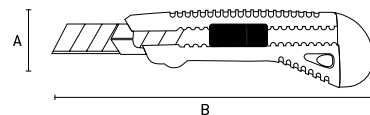

- **Usos Profissionais** | Professional Use | Uso Profesional
- **Corpo metálico body** | Metal Cuerpo metálico
- **Lâmina retrátil** | Retractable blade | Láminas retráctiles
- **Botão de trava e destrava para lâmina** | Lock and unlock button for blade | Botón de bloqueo y desbloqueo para lámina
- **Embalagem: Blister** | Packing: Blister | Embalaje: Blister

Estiletos

Stiletto | Estilete

AUTO SERVIÇO



789369	DIMENSÕES SIZE TAMAÑO (MM)		144	12
	A	B		

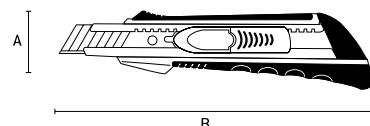

- **Corpo de metal reforçado** | Reinforced metal body | Cuerpo de metal reforzado
- **Sistema para corte de os e cabos** | Cable and wire cutting system | Sistema para corte de cables y cables
- **Botão de trava e destrava para lâmina** | Lock and unlock button for blade | Botón de bloqueo y desbloqueo para lámina
- **Indicado para corte de papel, papelão e outros materiais** | Suitable for cutting paper, cardboard and other materials | Indicado para corte de papel, cartón y otros materiales
- **Embalagem: Blister** | Packing: Blister | Embalaje: Blister

Sistema QUICK BLADE | QUICK BLADE system | Sistema QUICK BLADE



Estiletos

Stiletto | Estilete

BLISTER



789599	DIMENSÕES SIZE TAMAÑO (MM)		72	6
	A	B		

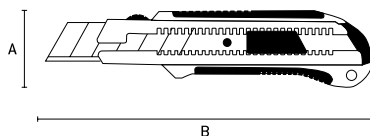

- **Usos Profissionais** | Professional Use | Uso Profesional
- **Corpo metálico** | Metal body | Cuerpo metálico
- **Lâmina retrátil** | Retractable blade | Láminas retráctiles
- **Botão de trava e destrava para lâmina** | Lock and unlock button for blade | Botón de bloqueo y desbloqueo para lámina
- **Embalagem: Blister** | Packing: Blister | Embalaje: Blister

Lâminas para estiletos

Stitching blades | Láminas para estiletos



antigo	novo	DIMENSÕES SIZE TAMAÑO (MM)		Quant. Min.
		A	B	
78968	7896855	9	100	20
78969	7896955	18	120	10

AUTO SERVIÇO

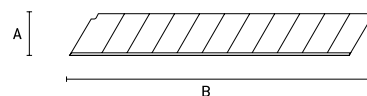

• Embalagem: tubete com furo expositor com 10 lâminas | Packaging: cartridge with 10-blade display hole | Embalaje: tubo con agujero expositor con 10 láminas

Estiletos

Stiletto | Estiletos



antigo	novo	DIMENSÕES SIZE TAMAÑO (MM)		Quant. Min.
		A	B	
78971	7897155	9	140	30

AUTO SERVIÇO

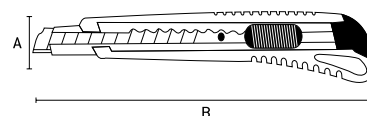

- **Usos Gerais** | General Use | Uso General
- **Corpo plástico com guia de metal** | Plastic body with metal guide | Cuerpo plástico con guía de metal
- **Lâmina retrátil** | Retractable blade | Láminas retráctiles
- **Botão para travamento da lâmina** | Blade Lock Button | Botón de bloqueo de la hoja
- **Embalagem: Blister** | Packing: Blister | Embalaje: Blister

Estiletos

Stiletto | Estiletos



antigo	novo	DIMENSÕES SIZE TAMAÑO (MM)		Quant. Min.
		A	B	
78972	7897255	9	150	50
78974	7897455	18	215	60

AUTO SERVIÇO

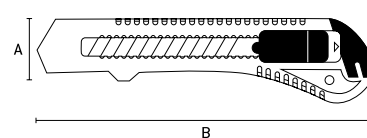
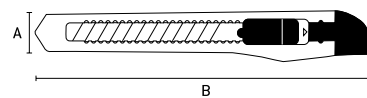

- **Usos Gerais** | General Use | Uso General
- **Corpo plástico** | Plastic body | Cuerpo plástico
- **Lâmina retrátil** | Retractable blade | Láminas retráctiles
- **Botão para travamento da lâmina** | Blade Lock Button | Botón de bloqueo de la hoja
- **Embalagem: Blister** | Packing: Blister | Embalaje: Blister

Jogo de estiletos

Stiletto set | Juego de estiletes



BLISTER



789859	288	12	



Composição:

- .01 estilete de 9 mm para uso geral.
- .01 estilete de 9 mm reforçado.
- .01 estilete de 18 mm reforçado.

- Lâminas retráteis e substituíveis | Retractable and replaceable blades | Láminas retractables y reemplazables
- Corpo plástico | Plastic body | Cuerpo plástico
- Embalagem: Blister | Packing: Blister | Embalaje: Blister

Jogo de estiletos

Stiletto set | Juego de estiletes



BLISTER



789919	4 unid. 9mm 2 unid. 18mm 2 unid. 40 e 62mm	96	12



Composição:

- .01 mini estilete para uso geral.
- .01 mini estilete de 9 mm para uso geral.
- .01 estilete de 9 mm para uso geral.
- .01 estilete de 9 mm reforçado.
- .01 estilete de 18 mm reforçado.
- .01 estilete com lâmina trapezoidal.
- .01 raspador de rejunte com lâmina fixa
- .01 raspador de rejunte com lâmina retrátil.

- Lâminas retráteis e substituíveis | Retractable and replaceable blades | Láminas retractables y reemplazables
- Corpo plástico | Plastic body | Cuerpo plástico
- Embalagem: Blister | Packing: Blister | Embalaje: Blister

Lâminas para estiletos

Stitching blades | Láminas para estiletes



AUTO SERVIÇO



	DIMENSÕES SIZE TAMAÑO (MM)			
	A	B		
7931159	9	101	800	20
7933159	18	121	300	10
7933259	25	146	100	20

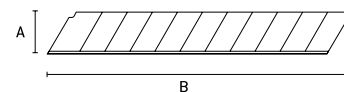

- Embalagem: tubete com furo expositor com 10 lâminas | Packaging: cartridge with 10-blade display hole | Embalaje: tubo con agujero expositor con 10 láminas

Lâminas para estiletos trapezoidais

Vane blades for trapezoidal style | Láminas para estiletes trapezoidales



	DIMENSÕES SIZE TAMAÑO (MM)			
	A	B		
7935559	9	68	480	48
7933359	18	-----	480	10*

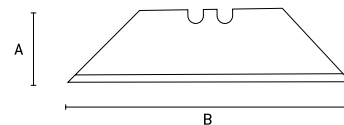

- Lâminas trapezoidal indicada para estiletos trapezoidais e raspadores | Trapezoidal blades indicated for trapezoidal styli and scrapers | Láminas trapezoidal indicada para estiletes trapezoidales y raspadores
- Embalagem : tubete com 5 lâminas | Packing: cartridge with 5 blades | Embalaje: tubo con 5 láminas
- Indicado para os produtos | Indicated for products | Indicado para los productos 789249, 789009, 789649, 789679
- Embalagem: caixa plástica | Packing: plastic box | Embalaje: caja plástica

Lâminas Serras

Saw blades | Láminas Sierras

AUTO SERVIÇO



777749	18 tpi	DIMENSÕES SIZE TAMAÑO (MM)		500	10
		A	B		
777729	24 tpi	40	300	500	10



• 777749
Flex

• 777729
Bi-metal

2 peças
parts | piezas

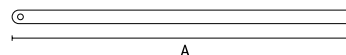

- Para arco de serra | For sawing bow | Para arco de sierra
- Embalagem: Blister | Packing: Blister | Embalaje: Blister

Lâminas para serra tico tico - Jogo

Saw Blades for Tactical Saw - Set | Láminas para sierra tico tico - Juego



781409	50 x 1,2 mm	DIMENSÕES SIZE TAMAÑO (MM)		200	20
		A			
781419	75 x 2,5 mm	75		200	20
781429	90 x 4,0 mm	90		200	20



3 peças
parts | piezas

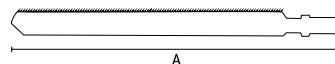

- Aço Carbono | Carbon steel | Acero carbono
- Encaixe para maquinário Bosc, AEG, Makita, Dewalt, Metabo | Bosch fitting | Encaje bosch
- Indicada para trabalhos com madeira maciça, compensados e plástico | Suitable for woodworking | Indicada para trabajos con madera
- Embalagem: Blister | Packing: Blister | Embalaje: Blister

Lâminas para serra tico tico - Jogo

Saw Blades for Tactical Saw - Set | Láminas para sierra tico tico - Juego



781509	75 x 1,2 mm, BIM	DIMENSÕES SIZE TAMAÑO (MM)		200	20
		A			
		75		200	20



3 peças
parts | piezas

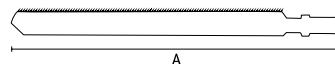

- Aço rápido bimetálico | Bimetal fast steel | Acero rápido bimetálico
- Encaixe para maquinário Bosc, AEG, Makita, Dewalt, Metabo | Bosch fitting | Encaje bosch
- Indicada para trabalhos com metais ferrosos e não ferrosos madeira maciça, compensados, MDF e plástico | Indicated for work with ferrous and non-ferrous metals | Indicada para trabajos con metales ferrosos y no ferrosos
- Embalagem: Blister | Packing: Blister | Embalaje: Blister

Jogo para serra tico tico

Tico-tico saw set | Juego para sierra Tico-tico



BLISTER



782019	T101B, 75 x 2,5 mm, HCS	DIMENSÕES SIZE TAMAÑO (MM)		200	25
		A			
782029	T101D, 75 x 4,0 mm, HCS	75		200	25

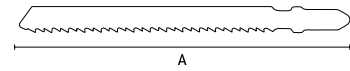

- Aço Carbono | Carbon steel | Acero carbono
- Encaixe bosch | Bosch fitting | Encaje bosch
- Indicada para trabalhos com madeira | Suitable for woodworking | Indicada para trabajos con madera
- Embalagem: Blister | Packing: Blister | Embalaje: Blister

Jogo para serra tico tico

Tico-tico saw set | Juego para sierra Tico-tico



BLISTER



782039	T101BR, 75 x 2,5 mm, HCS	DIMENSÕES SIZE TAMAÑO (MM)		200	25
		A			
782049	T144D, 75 x 4,0 mm, HCS	75		200	25

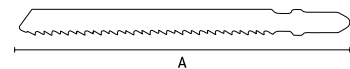

- Aço Carbono | Carbon steel | Acero carbono
- Encaixe bosch | Bosch fitting | Encaje bosch
- Indicada para trabalhos com madeira | Suitable for woodworking | Indicada para trabajos con madera
- Embalagem: Blister | Packing: Blister | Embalaje: Blister

Jogo para serra tico tico

Tico-tico saw set | Juego para sierra Tico-tico



BLISTER



782059	T111C, 75 x 3,0 mm, HCS	DIMENSÕES SIZE TAMAÑO (MM)		50	5*
		A			
782069	T118G, 50 x 0,8 mm, HSS	80		200	25

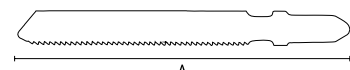
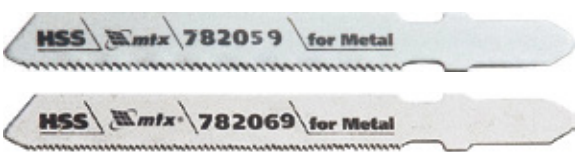

- Aço Carbono | Carbon steel | Acero carbono
- Encaixe bosch | Bosch fitting | Encaje bosch
- Embalagem: Blister | Packing: Blister | Embalaje: Blister



Jogo para serra tico tico

Tico-tico saw set | Juego para sierra Tico-tico



BLISTER



Código	Descrição	DIMENSÕES SIZE TAMAÑO (MM)			Quant. Min.
		A	B	C	
782079	T118A, 50 x 1,2 mm, HSS	50	200	25	
782089	T127D, 75 x 3,0 mm, HSS	75	200	25	

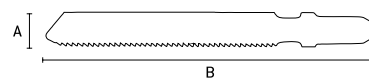

- Aço Carbono | Carbon steel | Acero carbono
- Encaixe bosch | Bosch fitting | Encaje bosch
- Embalagem: Blister | Packing: Blister | Embalaje: Blister

Jogo para serra tico tico

Tico-tico saw set | Juego para sierra Tico-tico



BLISTER



Código	Descrição	DIMENSÕES SIZE TAMAÑO (MM)			Quant. Min.
		A	B	C	
782099	T118AF, 55 x 1,2 mm, Bimetal	55	200	25	
782109	T101A0, 50 x 1,4 mm, HCS	50	200	25	

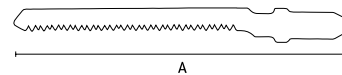
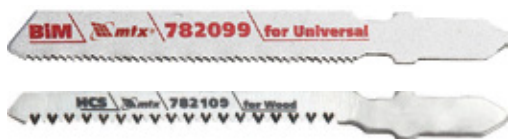

- Aço Carbono | Carbon steel | Acero carbono
- Encaixe bosch | Bosch fitting | Encaje bosch
- Indicada para trabalhos com serrar madeira, compensados, aglomerados de partículas, MDF | Suitable for sawing wood, plywood, particleboard, MDF | Indicada para trabajos con aserrar madera, compensados, aglomerados de partículas, MDF
- Embalagem: Blister | Packing: Blister | Embalaje: Blister

Jogo para serra tico tico

Tico-tico saw set | Juego para sierra Tico-tico



BLISTER



Código	Descrição	DIMENSÕES SIZE TAMAÑO (MM)			Quant. Min.
		A	B	C	
782119	T101BF, 75 x 2,5 mm, Bimetal	75	200	25	
782139	T101BRF, 75 x 2,5 mm, Bimetal	75	200	25	

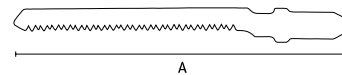

- Aço Carbono | Carbon steel | Acero carbono
- Encaixe bosch | Bosch fitting | Encaje bosch
- Indicada para trabalhos com serrar madeira, compensados, aglomerados de partículas, MDF | Suitable for sawing wood, plywood, particleboard, MDF | Indicada para trabajos con aserrar madera, compensados, aglomerados de partículas, MDF
- Embalagem: Blister | Packing: Blister | Embalaje: Blister

Jogo para serra tico tico

Tico-tico saw set | Juego para sierra Tico-tico



DIMENSÕES | SIZE | TAMAÑO (MM)



782159

T244D, 75 x 4,0 mm, HCS

75

200

25



BLISTER

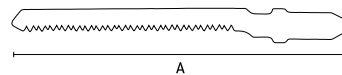

A

• Aço Carbono | Carbon steel | Acero carbono

• Encaixe bosch | Bosch fitting | Encaje bosch

• Indicada para trabalhos com serrar madeira, compensados, aglomerados de partículas, MDF |

Suitable for sawing wood, plywood, particleboard, MDF | Indicada para trabajos con aserrar madera, compensados, aglomerados de partículas, MDF

• Embalagem: Blister | Packing: Blister | Embalaje: Blister

Jogo para serra tico tico

Tico-tico saw set | Juego para sierra Tico-tico



DIMENSÕES | SIZE | TAMAÑO (MM)



782169

T301CD, 90 x 3,0 mm, HCS

90

200

25



BLISTER

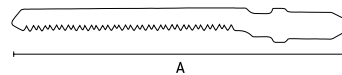

A

• Aço Carbono | Carbon steel | Acero carbono

• Encaixe bosch | Bosch fitting | Encaje bosch

• Indicada para trabalhos com serrar madeira, compensados, aglomerados de partículas, MDF |

Suitable for sawing wood, plywood, particleboard, MDF | Indicada para trabajos con aserrar madera, compensados, aglomerados de partículas, MDF

• Embalagem: Blister | Packing: Blister | Embalaje: Blister

Jogo de Lâminas de Serra para Madeira

Jigsaw Blade Set for Wood | Juego Láminas de Sierra para Madera



BLISTER



DIMENSÕES | SIZE | TAMAÑO (MM)



782509

T-SET3 (T101BR, T111C, T144D, T244D, T119B0)

8,0

72

400

100

782519

T-SET4 (T127D, T111C, T144D, T118A, T119B0)

8,0

72

400

100

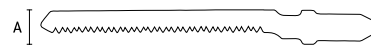

A

B

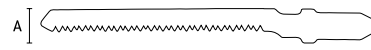

A

B

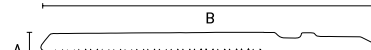

A

B

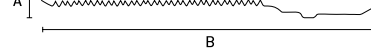

A

B

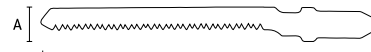

A

B

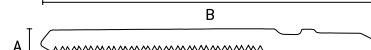

A

B

Tesoura para chapas corte reto

Shears for plates | Tijeras para chapas



antigo	novo	CS	DIMENSÕES SIZE TAMAÑO (MM)		Quant. Min.		
			A	B			
783125	7831255	8"	200 mm	50	200	100	5
783135	7831355	10"	250 mm	70	250	48	6
783145	7831455	12"	300 mm	80	300	36	6

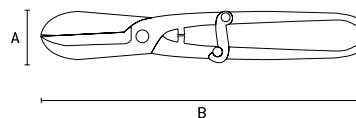

- Indicada para corte reto em chapas macias de até 1,0 mm | Suitable for straight cutting on soft sheets up to 1.0 mm | Indicada para corte recto en chapas suaves de hasta 1,0 mm
- Cabo de metal | Metal cable | Mango de metal
- Lâminas forjadas | Forged Blades | Láminas forjadas

Tesoura reta para chapas corte reto

Straight sheet shears | Tijeras rectas para chapas



	CS	DIMENSÕES SIZE TAMAÑO (MM)		Quant. Min.	
		A	B		
783309	10" (250 mm)	95	250	60	6

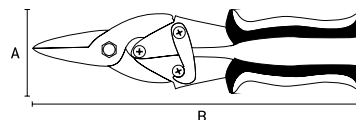

- Cabo de dois componentes | Two-component cable | Mango de dos componentes
- Corte reto em chapas de até 1,0 mm de espessura | Straight cut in sheets up to 1.0 mm thick | Corte recto en chapas de hasta 1,0 mm de espesor

Tesoura direita para chapas corte à direita

Right Scissor for Sheets | Tijera derecha para chapas



	CS	DIMENSÕES SIZE TAMAÑO (MM)		Quant. Min.	
		A	B		
783329	10" (250 mm)	95	250	48	6

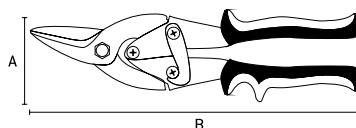

- Cabo de dois componentes | Two-component cable | Mango de dos componentes
- Corte a direita em chapas de até 1,0 mm de espessura | Cut to the right in sheets up to 1.0 mm thick | Corte a la derecha en chapas de hasta 1,0 mm de espesor
- Embalagem: Blister | Packing: Blister | Embalaje: Blister

Tesoura esquerda para chapas corte à esquerda

Left-handed scissors for plates | Tijera izquierda para chapas



	CS	DIMENSÕES SIZE TAMAÑO (MM)		Quant. Min.	
		A	B		
783349	10" (250 mm)	95	250	48	6

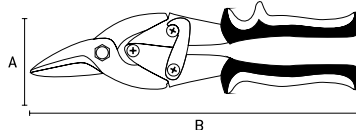

- Cabo de dois componentes | Two-component cable | Mango de dos componentes
- Corte a esquerda em chapas de até 1,0 mm de espessura | Cut to the left in sheets up to 1.0 mm thick | Corte a la izquierda en chapas de hasta 1,0 mm de espesor

Arco de serra
Saw arch | Arco de sierra



7754355	8"-12"	DIMENSÕES SIZE TAMAÑO (MM)		48	12
		A	B		

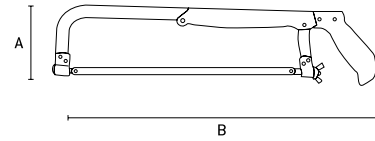

- Estrutura metálica | Metal structure | Estructura metálica
- Regulável de 8" a 12" | Adjustable from 8" to 12" | Regulable de 8" a 12"
- Acompanha : lâmina de serra de aço carbono | Comes with: carbon steel saw blade | Acompaña: lâmina de serra de aço carbono

Mini arco de serra de metal
Mini sawing bow | Mini arco de sierra



7756059	10"	DIMENSÕES SIZE TAMAÑO (MM)		120	12
		A	B		

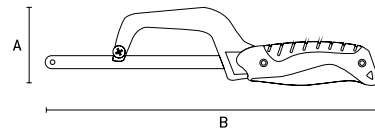

- Estrutura ergonômica em alumínio fundido | Ergonomic structure in cast aluminum | Estructura ergonômica en aluminio fundido
- Podem ser utilizadas lâminas quebradas desde que se tenha pelo menos 90 mm (3 1/2" para encaixe) | Pueden utilizarse cuchillas rotas siempre que se tenga al menos 90 mm (3 1/2" para encaje) | Pueden utilizarse cuchillas rotas siempre que se tenga al menos 90 mm (3 1/2" para encaje)
- Parafuso para travar a lâmina | Screw to lock blade | Tornillo para bloquear la cuchilla
- Cabo com dois componentes emborrachado | Rubberized two component cable | Mango con dos componentes de goma
- Acompanha: lâmina de serra de aço carbono | Comes with: carbon steel saw blade | Acompaña: lâmina de serra de aço carbono
- Embalagem: Blister | Packing: Blister | Embalaje: Blister

Arco de serra
Saw arch | Arco de sierra



antigo	novo	10"-12"	DIMENSÕES SIZE TAMAÑO (MM)		60	10
775765	7757655		A	B		

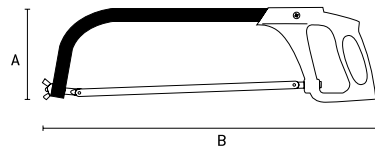

- Estrutura de aço tubular | Metal structure | Estructura metálica
- Cabo plástico ABS de alta resistência | Metal structure | Estructura metálica
- Regulável de 10" a 12" | Adjustable from 10" to 12" | Regulable de 10" a 12"
- Acompanha : lâmina de serra de aço carbono | Comes with: carbon steel saw blade | Acompaña: lâmina de serra de aço carbono

Arco de serra
Sawing bow | Arco de sierra



775939	12"	DIMENSÕES SIZE TAMAÑO (MM)		24	4
		A	B		

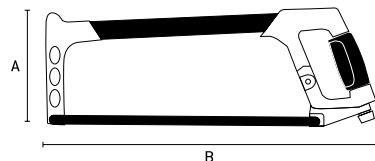

- Lâmina pode ser posicionada à 55° ou 90° | Blade can be positioned at 55° or 90° | La hoja puede colocarse a 55° o 90°
- Cabo ergonômico emborrachado | Rubberized ergonomic handle | Mango ergonômico emborrachado
- Permite armazenar lâminas sobressalentes na base | Store spare blades in base | Permite almacenar cuchillas de repuesto en la base
- Parafuso tensionador | Tensioning screw | Tornillos tensores
- Acompanha: lâmina bimetálica | Comes with: bimetal blade | Acompaña: lâmina bimetálica

Tesoura corta vergalhões

Scissors cuts rebar | Tijera corta barras

HRC
58-60



Código	Tamanho (polegadas)	DIMENSÕES SIZE TAMAÑO (MM)		Quant. Min.
		A	B	
785259	12"	110	300	30
785309	14"	115	350	30
785359	18"	135	450	20
785409	24"	155	600	10
785459	30"	170	750	5
785559	36"	185	900	5
785609	42"	233	1050	3
785659	48"	230	1200	3

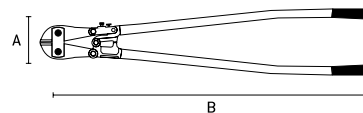

- Aço carbono | Carbon steel | Acero carbono
- Para cortar vergalhões/ ferro para construção | To cut rebar / iron for construction | Para cortar barras de acero / hierro para la construcción
- Cabo vermelho com empunhadura plástica preta | Red metal cable with black plastic grip | Mango de metal rojo con empuñadura plástica negra
- Embalagem: Caixa | Packing: Box | Embalaje: Caja

Cortador de tubos de PVC

PVC pipe cutter | Cortador de tubos de PVC



Código	Tamanho (mm)	DIMENSÕES SIZE TAMAÑO (MM)		Quant. Min.
		A	B	
7841059	d42mm	120	255	48
784129	d42mm	120	290	48

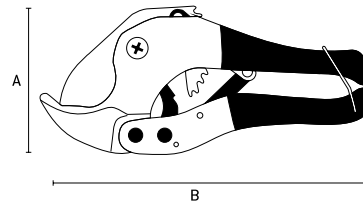

- Sistema de catraca | Ratchet system | Sistema de trinquete
- Para tubos de PVC de até 42 mm | For PVC pipes up to 42 mm | Para tubos de PVC de hasta 42 mm
- Corpo metálico e lâmina de aço | Metal body and steel blade | Cuerpo metálico y lámina de acero
- Não deixa rebarba | Do not let burr | No deja rebarba
- Embalagem: Blister | Packing: Blister | Embalaje: Blister

Mini cortador de tubos

Mini tube cutter | Mini cortador de tubos



Código	Tamanho (polegadas)	DIMENSÕES SIZE TAMAÑO (MM)		Quant. Min.
		A	B	
787209	1/8" a 1.3/3.2" (3 a 28 mm)	92	180	50

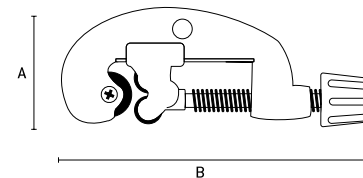

- Indicado para cortar tubos de cobre, alumínio e latão | Suitable for cutting copper, aluminum and brass tubes | Indicado para cortar tubos de cobre, aluminio y latón
- Corpo de alumínio injetado | Injected aluminum body | Cuerpo de aluminio inyectado
- Pintura eletrostática | Electrostatic painting | Pintura electrostática
- Cilindros polidos para fácil rotação | Polished cylinders for easy rotation | Cilindros pulidos para una fácil rotación
- Escareador de tubos embutido na lateral | Built-in tube reamer | Extractor de tubos incrustado en el lateral
- Embalagem: Blister | Packing: Blister | Embalaje: Blister

Canivete

Switchblade | Cortaplumas



BLISTER



7899855

DIMENSÕES | SIZE | TAMAÑO (MM)

A

B



180



20

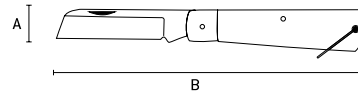

- Lâmina em aço inox, reta | Metal blade | Metal blade
- Cabo de madeira | Forged Blades | Láminas forjadas
- Embalagem: Blister | Forged Blades | Láminas forjadas

Afiador de facas

Knife sharpener | Afilador de cuchillos



BLISTER



791059



Universal

DIMENSÕES | SIZE | TAMAÑO (MM)

A

B



72



12

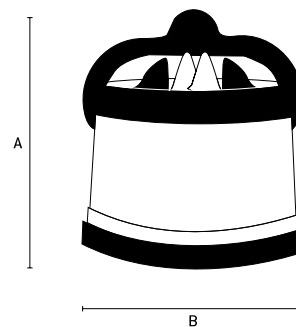

- Corpo Plástico | Plastic Body | Cuerpo Plástico
- Ventosa para fixação | Suction cup for fixing | Ventosa para fijación
- 2 pastilhas de metal duro (Wídea) sobrepostas em "V" | 2 carbide inserts (Wídea) superimposed on "V" | 2 pastillas de metal duro (Wídea) sobrepuestas en "V"
- Embalagem: Blister | Packing: Blister | Embalaje: Blister

Afiador de facas

Knife sharpener | Afilador de cuchillos



BLISTER



791009



Universal

DIMENSÕES | SIZE | TAMAÑO (MM)

A

B



72



12

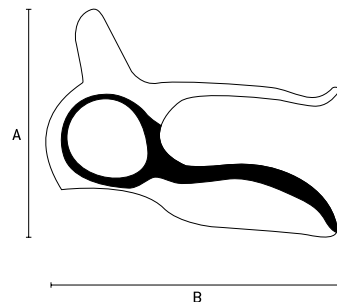

- Corpo Plástico | Plastic Body | Cuerpo Plástico
- Ventosa para fixação | Suction cup for fixing | Ventosa para fijación
- 2 pastilhas de metal duro (Wídea) sobrepostas em "V" | 2 carbide inserts (Wídea) superimposed on "V" | 2 pastillas de metal duro (Wídea) sobrepuestas en "V"
- Embalagem: Blister | Packing: Blister | Embalaje: Blister

Raspadores de rejunte

Grout Scrapers | Rascadores de rejunte

AUTO
SERVIÇO



795459	DIMENSÕES SIZE TAMAÑO (MM)		100	10
	A	B		
	110	100		

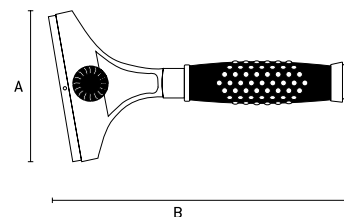

- Universal | Universal | Universal
- Cabo de metal emborrachado | Rubberized metal cable | Mango de metal emborrachado
- Lâmina Fixa | Fixed Blade | Lámina fija
- Embalagem: Blister | Packing: Blister | Embalaje: Blister

Raspadores de rejunte

Grout Scrapers | Rascadores de rejunte

BLISTER



795609	DIMENSÕES SIZE TAMAÑO (MM)		100	10
	A	B		
	100	250		

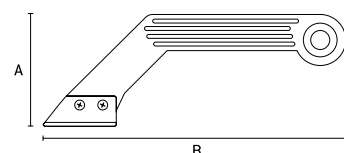

- Para remoção de rejunte/ juntas em pisos e paredes | For removal of grout / joints on floors and walls | Para la remoción de rejunte / juntas en pisos y paredes
- Cabo em polipropileno | Cable in polypropylene | Mango de polipropileno
- Pode ser utilizada 1 ou 2 lâminas, dependendo da espessura da junta a ser removida | 1 or 2 blades can be used, depending on the thickness of the joint to be removed | Se puede utilizar 1 ó 2 láminas, dependiendo del grosor de la junta a ser removida
- Lâmina metálica de tungstênio | Tungsten metal blade | Lámina metálica de tungsteno
- Embalagem: Blister | Packing: Blister | Embalaje: Blister



JOGO PARA SERRA TICO TICO

TICO-TICO SAW SET | JUEGO PARA SIERRA TICO-TICO



AÇO CARBONO
Carbon steel
Acero carbono

ENCAIXE BOSCH
Bosch fitting
Encaje bosch

PARA TRABALHOS COM MADEIRA ou METAL
For works with wood or metal
Para trabajos con madera o metal

ACABAMENTO

FINISHING | ACABADO



FERRAMENTAS DE ACABAMENTO

Finishing's Tools Herramientas de Acabado

As ferramentas de construção e acabamento MTX. Proporcionam ao profissional ou consumidor final um produto de extrema eficiência para o trabalho a ser desenvolvido. Utilizando matérias primas de qualidade as ferramentas tem um ótimo desempenho e proporcionam um excelente resultado.

MTX construction and finishing tools. They provide the professional or final consumer an extremely efficient product for the work to be developed. Using quality raw materials the tools have a great performance and provide an excellent result.

Como herramientas de construcción y acabado MTX. Proporcionar al profesional o Consumidor final un producto de extrema eficacia para el trabajo a ser desarrollado. Cómo utilizar las herramientas como tiene un rendimiento óptimo y proporcionan un excelente resultado.

SIMBOLOGIA



CÓDIGO
CODE



CARACTERÍSTICAS
Technical Features



PESO DA PEÇA
Part Weight
Peso de la Pieza



CAIXA MASTER
Box Master | Caja Máster



QUANT. MINÍMA
Quant. Minimum
Cantidad Mínimo

Colher de pedreiro RETA

Straight trowel spoon | Cuchara de albañil recta



8621155	7" (175mm)	270g	DIMENSÕES SIZE TAMAÑO (MM)			20	1
			A	B	C		
8621255	8" (200mm)	325g	155	320	90	20	1

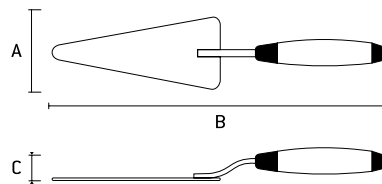

Colher de pedreiro OVAL

OVAL Trowel | Cuchara de albañil OVAL



8620155	7" (175mm)	270g	DIMENSÕES SIZE TAMAÑO (MM)			20	1
			A	B	C		
8620255	8" (200mm)	325g	155	320	90	20	1
8620355	9" (225mm)	380g	195	320	90	20	1

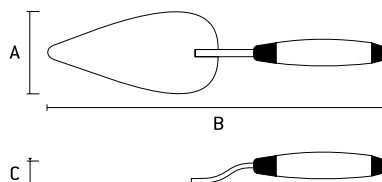

Rolo para pintura de canto

Roll for corner painting | Rodillo para pintura de esquina



806809	altura 12mm	188g	DIMENSÕES SIZE TAMAÑO (MM)			100	20
			A	B	C		
			90	440	55		

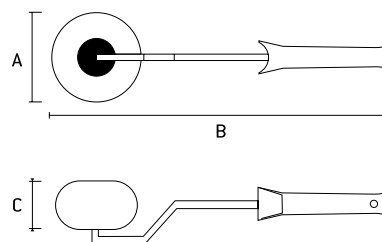

- Fibra sintética | Synthetic fiber | Fibra sintética
- Para utilizar em cantos para acabamento e em lugares de difícil acesso | for use in finishing corners and in hard-to-reach places | para utilizar en esquinas para acabado y en lugares de difícil acceso



Cabo telescópico

Telescopic cable | Mango telescópico



812329



800g

DIMENSÕES | SIZE | TAMANHO (MM)

A

B



20



1

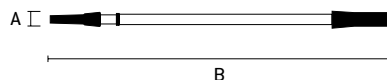

- Para rolos de pintura | For paint rollers | Para los rodillos de pintura
- Metálico | Metallic | Metálico

Lápis de marceneiro / carpinteiro

Woodworking pencils | Lápiz de carpintería



848045



8480455



105g

DIMENSÕES | SIZE | TAMANHO (MM)

A

B



120



1

8480555

138g

20

180

120

1

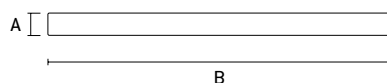

- Grafite em formato retangular | Rectangular graphite | Grafito en formato rectangular
- Indicado para marcações em madeira | Suitable for wood marking | Indicado para marcas de madera
- Embalagem: Caixa | Packing: Box | Embalaje: Caja

Carretel de linha com giz para drywall

Spool line with drywall chalk | Carrete de línea con tiza para drywall



848559



115g - vermelho

DIMENSÕES | SIZE | TAMANHO (MM)

A

B



50



25



BLISTER



- Giz vermelho | Red chalk | Giz rojo

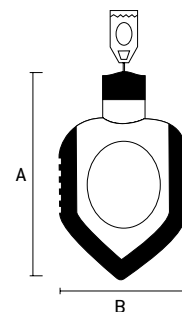

- Carretel plástico com 30 metros de linha de algodão e tubo de 115g com giz | Plastic spool with 30 meters cotton line and 115g tube with chalk | Carrete plástico con 30 metros de línea de algodón y tubo de 115g con tiza
- Embalagem: Blister | Packing: Blister | Embalaje: Blister

Pó de giz

Chalk powder | Polvo de tiza



848579



50g - vermelho

DIMENSÕES | SIZE | TAMANHO (MM)

A

B



200



20

848589

115g - vermelho

160

50

200

20



- Giz vermelho | Red chalk | Giz rojo

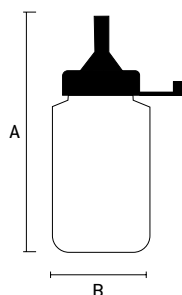

- Indicado para ser utilizado com linha de algodão para marcações em parede | Suitable for use with cotton thread for wall markings | Indicado para ser utilizado con línea de algodón para marcaciones en pared

8

Misturador de tinta

Ink Mixer | Mezclador de tinta



AUTO SERVIÇO



- Indicado para misturar tinta | Suitable for mixing ink | Indicado para mezclar tinta
- Em aço carbono | Carbon steel | En acero al carbono
- Acabamento pintado | Painted finish | Acabado pintado
- Haste Sextavada | Hexagonal stem | Vástago Sextavada
- Embalagem: Blister | Packing: Blister | Embalaje: Blister

Barcode	KG	DIMENSÕES SIZE TAMAÑO (MM)		Quant. Min.	
		A	B		
848709	229g	58	423	20	1
848749	270g	86	427	20	1
848759	515g	88	623	20	1

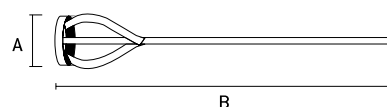

Misturador de tinta com encaixe SDS Plus

Ink Mixer | Mezclador de tinta



AUTO SERVIÇO



- Indicado para misturar tinta, massa, gesso | Suitable for mixing paint, grease, plaster | Indicado para mezclar tinta, masa, yeso
- Em aço carbono | Carbon steel | En acero al carbono
- Encaixe SDS-PLUS | SDS-PLUS socket | Encaje SDS-PLUS
- Embalagem: Blister | Packing: Blister | Embalaje: Blister

Barcode	KG	DIMENSÕES SIZE TAMAÑO (MM)		Quant. Min.	
		A	B		
848259	402 g	60	400	20	1
848269	450 g	80	455	20	1
848279	515g	103	460	20	1
848289	625g	120	610	20	1
848819	362g	60	405	36	12
848829	402 g	80	403	12	1
848839	683g	100	610	12	1
848849	642g	120	610	12	1

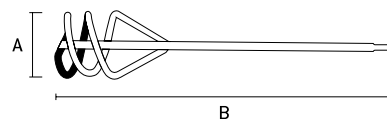

Misturador de massa com haste sextavada

Mass Mixer | Mezclador de masa



AUTO SERVIÇO



- Indicado para misturar tinta, massa, gesso | Suitable for mixing paint, grease, plaster | Indicado para mezclar tinta, masa, yeso
- Em aço carbono | Carbon steel | En acero al carbono
- Haste Sextavada | Hexagonal stem | Vástago Sextavada
- Embalagem: Blister | Packing: Blister | Embalaje: Blister

Barcode	KG	DIMENSÕES SIZE TAMAÑO (MM)		Quant. Min.	
		A	B		
848419	356g	80	540	32	16
848439	274g	60	405	36	18
848449	288g	80	405	36	6
848459	626g	100	610	12	6
848469	715g	120	610	12	6

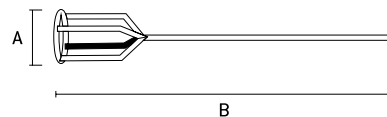

Espátula / Betumadeira de aço

Steel spatula | Espátula de acero



antigo	novo	mm	KG	DIMENSÕES SIZE TAMAÑO (MM)		Quant. Min.
				A	B	
852065	8520655	1,1/2" (40mm)	39g	40	180	12
852095	8520955	2" (50mm)	44g	50	180	12
852125	8521255	2,1/4" (60mm)	50g	60	205	12
852155	8521555	3,1/8" (80mm)	54g	80	205	12
852185	8521855	4" (100mm)	71g	100	240	12

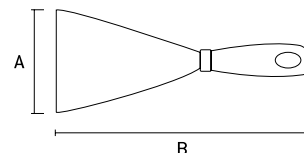

- Lisa | Smooth | Liso
- Cabo de madeira | Wooden handle | Mango de madera

Espátulas cabo de PVC

PVC cable spatulas | Espátulas de mango de PVC



	mm	KG	DIMENSÕES SIZE TAMAÑO (MM)		Quant. Min.
			A	B	
855029	8" (200mm)	242g	200	260	6
855039	12" (300mm)	317g	300	260	6
855049	1,1/2" (40mm)	80g	40	210	12
855059	2" (50mm)	83g	50	210	12
855069	2,1/4" (60mm)	86g	60	210	12
855089	3,1/8" (80mm)	90g	80	210	12
855109	4" (100mm)	102g	100	210	12
855129	6" (150mm)	108g	120	210	12
855139	8" (200mm)	242g	130	210	10*
855149	10" (250mm)	280g	130	210	10*
855169	12" (300mm)	317g	130	210	10*
855179	14" (350mm)	380g	130	210	10*
855189	19" (475mm)	410g	130	210	10*
855199	24" (600mm)	450g	130	210	10*



• 855029 - 855039



• 855049 - 855129



• 855139 - 855199

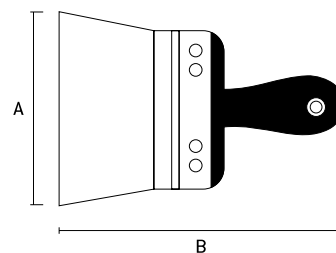
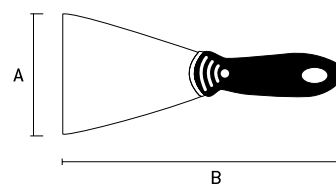
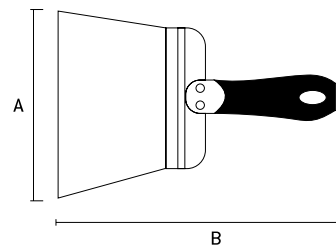

- Cabo anatômico em polipropileno revestido com PVC | Anatomic cable made of polypropylene coated with PVC | Mango anatómico en polipropileno revestido con PVC
- Lâmina em aço inox especial de alta resistência | Special high strength stainless steel blade | Lámina de acero inoxidable especial de alta resistencia



Cortador de vidro

Glass cutter | Cortador de cristal



antigo	novo	KG	DIMENSÕES SIZE TAMAÑO (MM)				Quant. Min.
872235	8722355	25g	A	B	C	480	12

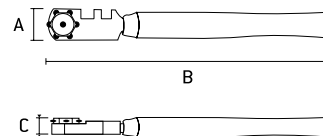

- 6 rodas | 6 wheels | 6 ruedas
- Cabo de madeira | Wooden handle | Mango de madeira
- Embalagem: Caixa | Packing: Box | Embalaje: Caja

Cortador de vidro cabo metálico

Glass cutter | Cortador de cristal



		KG	DIMENSÕES SIZE TAMAÑO (MM)				Quant. Min.
872649	97g	60	A	B	C	240	12

AUTO SERVIÇO



- Com reservatório para lubrificante
- Cabo de metal | Metal handle | Mango de metal
- Embalagem: Blister | Packing: Blister | Embalaje: Blister

Alicate punçador para drywall

Pliers punch for drywall | Alicate punzonador para drywall



		KG	DIMENSÕES SIZE TAMAÑO (MM)			Quant. Min.
879519	225mm	570g	A	B	24	6

AUTO SERVIÇO

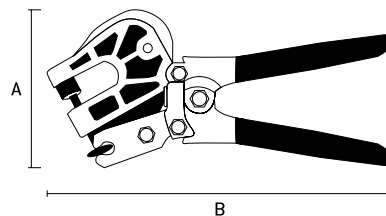

- Cabeçote em alumínio fundido | Die cast aluminum head | Cabezal de aluminio fundido
- Cabo em chapa de aço estampado cromado e plástico | Cable in steel plate, chromed and plastic | Cable en chapa de acero estampado cromado y plastico
- Funcionamento manual | Manual Operation | Funcionamiento manual
- Embalagem: Blister | Packing: Blister | Embalaje: Blister

Prumo de aço

Steel plumbing | Prumo de acero

AUTO
SERVIÇO



848329	200g - cordão 5mt	212g	DIMENSÕES SIZE TAMAÑO (MM)		60	6
			A	B		
848339	300g - cordão 5mt	292g	160	50	60	6

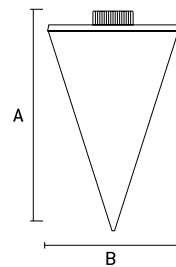

- Corpo de Aço | Body of Steel | Cuerpo de acero
- Cordão de 5m | 5m Cord | Cordon de 5m
- Cordão de Nylon | Nylon cord | Cordon de Nylon
- Embalagem: Blister | Packing: Blister | Embalaje: Blister

Fita adesiva

Scotch tape | Cinta adhesiva



890009	86g	DIMENSÕES SIZE TAMAÑO (MM)		100	1
		A	B		
890049	264g	50	140mt	36	1*



- Fita adesiva de fibra de vidro, para parede | Glass Adhesive Tape for Wall | Cinta adhesiva de cristal, para pared
- Tela de vidro trançada com adesivo acrílico | Glass screen braided with acrylic adhesive | Pantalla de cristal trenzado con adhesivo acrílico
- Indicado para junções em paredes | Suitable for joints in walls | Indicado para uniones en paredes

8

Ventosa Plástica

Plastic Suction Cup | Ventosa Plástica

Spartan	mtx	KG	DIMENSÕES SIZE TAMANHO (MM)			Quant. Min.	
			A	B	C		
875155	8751555	667g	130	325	85	12	1
875055	8750555	339g	130	125	105	36	1



- 875155
Capacidade máxima de carga: 80 Kg |
Maximum load capacity: 80 kg | Capacidad máxima de carga: 80 Kg
Ventosa Dupla | Double Suction cup | Ventosa Doble

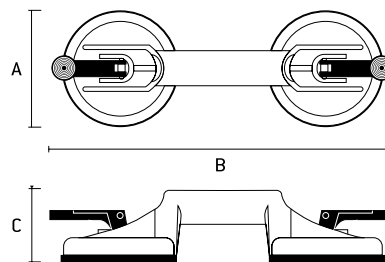

- 8750555
Capacidade máxima de carga: 40 Kg |
Maximum load capacity: 40 kg | Capacidad máxima de carga: 40 Kg
Ventosa Simples | Simple Suction cup | Ventosa Simple

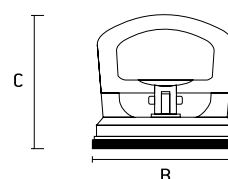

- Indicado para elevar/transportar peças planas, lisas, vidros, chapas, espelhos e portas |
Suitable for lifting / transporting flat, flat parts, glass, plates, mirrors and doors |
Indicado para elevar / transportar piezas planas, lisas, vidrios, chapas, espejos y puertas
- Ventosa de borracha com sistema de sucção | Suction cup with suction system | Ventosa de goma con sistema de succión
- Suporte e alça de alumínio | Aluminum bracket and handle | Soporte y mango de aluminio
- Embalagem: Caixa | Packing: Box | Embalaje: Caja

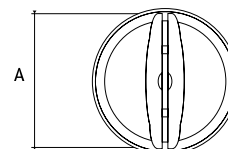

Ventosas de Alumínio (Uso Profissional)

Aluminum Suction Cups (Professional Use) | Ventosas de Aluminio (Uso Profesional)



Barcode	KG	DIMENSÕES SIZE TAMANHO (MM)			Quant. Min.	
		A	B	C		
8752059	882g	125	330	95	12	1
8752559	1317g	240	340	85	6	1



- 8752059
Ventosa Dupla |
DoubleSuction cup | Ventosa Doble
- Capacidade máxima de carga: 100 Kg |
Maximum load capacity: 100 kg |
Capacidad máxima de carga: 100 Kg

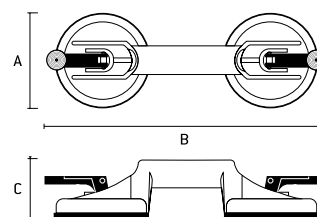

- 8752559
Ventosa Tripla |
Triple Suction cup | Ventosa Triple
- Capacidade máxima de carga: 120 Kg |
Maximum load capacity: 120 kg |
Capacidad máxima de carga: 120 Kg

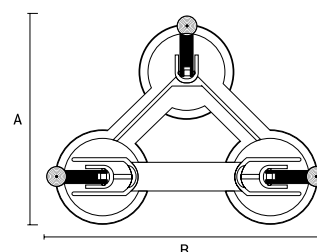

- Indicado para elevar/transportar peças planas, lisas, vidros, chapas, espelhos e portas |
Suitable for lifting / transporting flat, flat parts, glass, plates, mirrors and doors |
Indicado para elevar / transportar piezas planas, lisas, vidrios, chapas, espejos y puertas
- Ventosa de borracha com sistema de sucção |
Suction cup with suction system | Ventosa de goma con sistema de succión
- Suporte e alça de alumínio | Aluminum bracket and handle | Soporte y mango de aluminio
- Embalagem: Caixa | Packing: Box | Embalaje: Caja

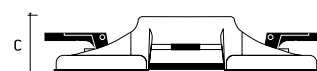

Cortador de cerâmica e azulejos

Ceramic and tile cutter | Cortador de cerâmica y azulejos



	Barcode	KG	DIMENSÕES SIZE TAMAÑO (MM)			Quant. Min.
			A	B	C	
8765155	600mm	3.800g	200	650	200	1
8765255	750mm	4.500g	200	800	200	1
8765355	900mm	5.100g	200	950	200	1

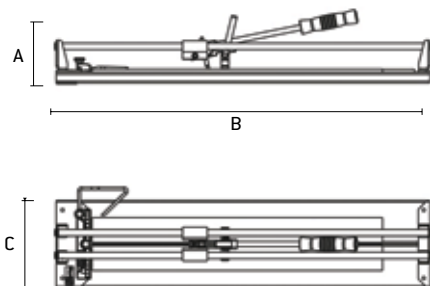

- **Uso Profissional** | Professional Use | Uso Profesional
- **Projetado para cortar uma espessura de até 14mm** | Designed to cut a thickness of up to 14mm | Diseñado para cortar un grosor de hasta 14mm
- **Com régua e separador para ajustar o tamanho e a fixação da peça a ser cortada**
With ruler and separator to adjust the size and fixation of the part to be cut
- **Con regleta y separador para ajustar el tamaño y la fijación de la pieza a ser cortada**
- **Embalagem: Caixa** | Packing: Box | Embalaje: Caja

Rodel para cortador de pisos

Rodel for floor cutter | Rodillo para cortador de pisos



	Barcode	KG	DIMENSÕES SIZE TAMAÑO (MM)		Quant. Min.
			A	B	
8766055		50g	10	80	250



BLISTER



- **Metal Duro** | Professional Use | Uso Profesional
- **Embalagem: Blister** | Packing: Blister | Embalaje: Blister

Cortador de cerâmica em círculo

Ceramic cutter in a circle | Cortador de cerámica en círculo



	Barcode	KG	DIMENSÕES SIZE TAMAÑO (MM)			Quant. Min.
			A	B	C	
882409		290g	125	125	125	20

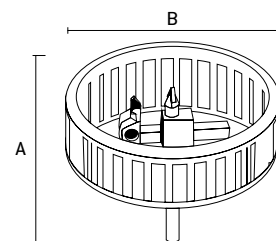

- **A broca circular com uma grade de plástico de proteção é destinada a fazer furos** | The circular drill with a protective plastic grid is designed to drill holes | La broca circular con una rejilla de plástico de protección está destinada a hacer agujeros
- **O desenho da broca é ajustável ao diâmetro de corte na gama de 20 a 94mm** | The drill pattern is adjustable to the cutting diameter in the range of 20 to 94mm | El diseño de la broca es ajustable al diámetro de corte en la gama de 20 a 94 mm
- **Embalagem: Caixa** | Packing: Box | Embalaje: Caja

Aplicador de silicone aberto

Silicone applicator | Aplicador de silicona



antigo	novo	KG	DIMENSÕES SIZE TAMANHO (MM)			Quant. Min.
886125	8861255	292g	A	B	24	1

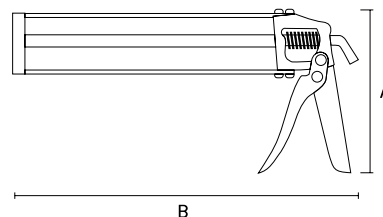

- Metálico | Metallic | Metálico
- Para tubos de até 310g/315ml | For tubes up to 310g / 315ml | Para tubos de hasta 310g / 315ml

Aplicador metálico de silicone semiaberto

Silicone metal applicator | Aplicador metálico de silicona



antigo	novo	KG	DIMENSÕES SIZE TAMANHO (MM)			Quant. Min.
886365	8863655	319g	A	B	36	1

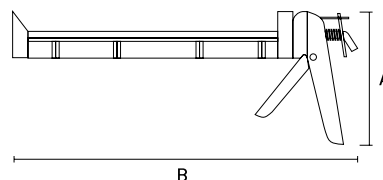

- O desenho da carcaça é reforçado por nervuras transversais | The housing design is reinforced by transverse ribs | El diseño de la carcasa se ve reforzado por nervaduras transversales
- Para tubos de até 310g/315ml | For tubes up to 310g / 315ml | Para tubos de hasta 310g / 315ml

Aplicador de silicone fechado

Silicone applicator | Aplicador de silicona



antigo	novo		KG	DIMENSÕES SIZE TAMANHO (MM)			Quant. Min.
886475	8864755	400mm	600g	A	B	20	1
886485	8864855	750mm	725g	60	550	20	1

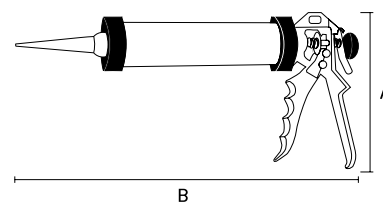

- Metálico | Metallic | Metálico

Espaçador para piso, plástico

Floor spacer, plastic | Espaciador de suelo, plástico



		KG		Quant. Min.
880685	20mm	44g	200	1*

AUTO SERVIÇO



- Indicado para o espaçamento correto de cerâmicas (para fazer rejunte) | Indicated for correct spacing of ceramics (for grouting) | Indicado para el espaciado correcto de cerámicas (para hacer rejunte)
- Embalagem: Blister | Packing: Blister | Embalaje: Blister



ACESSÓRIOS PARA FERRAMENTAS

Fittings for Tools
Accesorios para Herramientas

As ferramentas de construção e acabamento MTX. Proporcionam ao profissional ou consumidor final um produto de extrema eficiência para o trabalho a ser desenvolvido. Utilizando matérias primas de qualidade as ferramentas tem um ótimo desempenho e proporcionam um excelente resultado.

MTX construction and finishing tools. They provide the professional or final consumer an extremely efficient product for the work to be developed. Using quality raw materials the tools have a great performance and provide an excellent result.

Como herramientas de construcción y acabado MTX. Proporcionar al profesional o Consumidor final un producto de extrema eficacia para el trabajo a ser desarrollado. Cómo utilizar las herramientas como tiene un rendimiento óptimo y proporcionan un excelente resultado.

SIMBOLOGIA



CÓDIGO
CODE



CARACTERÍSTICAS
Technical Features



PESO DA PEÇA
Part Weight
Peso de la Pieza



CAIXA MASTER
Box Master | Caja Máster



QUANT. MINÍMA
Quant. Minimum
Cantidad Mínimo

Rodízio giratório sem freio

Fixed caster without brake | Rodamiento fijo sin freno



Barcode	Icon	DIMENSÕES SIZE TAMAÑO (MM)	Quant. Min.		
			Box	Stack	
6871655		5" (125 mm) suporta até 100 kg	125	30	1
6871755		6.5/16" (160 mm) suporta até 135 kg	160	12	1
6871855		8" (200 mm) suporta até 165 kg	200	8	1
6872555		2" (50 mm) suporta até 27 kg	50	170	1
6872655		4.1/2" suporta até 45 kg	115	80	1
6872755		5.1/8" suporta até 55 kg	130	40	1

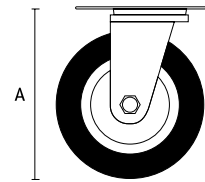

- Roda de borracha preta | Black Rubber Wheel | Rueda de goma negra

Rodízio giratório com freio

Rotary caster with brake | Rueda giratoria con freno



Barcode	Icon	DIMENSÕES SIZE TAMAÑO (MM)	Quant. Min.		
			Box	Stack	
6871955		2" (50 mm) suporta até 25Kg	50	170	1
6872055		3" (75 mm) suporta até 45Kg	75	80	1
6872155		4" (100 mm) suporta até 55Kg	100	40	1

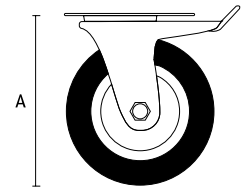

- Roda de borracha cinza | Grey Rubber Wheel | Rueda de goma gris

Rodízio PVC fixo sem freio

Fixed PVC caster without brake | Rodamiento de PVC fijo sin freno



Barcode	Icon	DIMENSÕES SIZE TAMAÑO (MM)	Quant. Min.		
			Box	Stack	
6870755		2" (50 mm) suporta até 25Kg	50	200	1
6870855		3" (75 mm) suporta até 45Kg	75	85	1
6870955		4" (100 mm) suporta até 55Kg	100	50	1

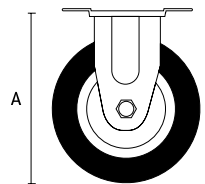

- Roda de borracha cinza e PVC | Gray Rubber Wheel and PVC | Rueda de goma gris y PVC

Rodízio PVC giratório sem freio

Rotary PVC caster with brake | Rueda PVC giratoria con freno



Barcode	Icon	DIMENSÕES SIZE TAMAÑO (MM)	Quant. Min.		
			Box	Stack	
6871355		2" (50 mm) suporta até 25Kg	50	200	1
6871455		3" (75 mm) suporta até 45Kg	75	85	1
6871555		4" (100 mm) suporta até 55Kg	100	50	1

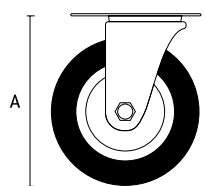

- Roda de borracha cinza e PVC | Gray Rubber Wheel and PVC | Rueda de goma gris y PVC

Rodízio de GEL giratório sem freio

Rotary GEL caster without brake | Rueda de GEL giratoria sin freno



Barcode	Description	DIMENSÕES SIZE TAMAÑO (MM)			Quant. Min.
		A	W	H	
6873155	1.3/8" suporta até 20Kg	35	200	1	
6873255	2" (50 mm) suporta até 35Kg	50	85	1	
6873355	3" (75 mm) suporta até 55Kg	75	50	1	

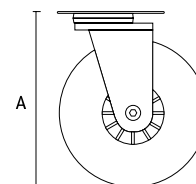

Rodízio de GEL giratório com freio

Rotary GEL caster with brake | Rueda de GEL giratoria con freno



Barcode	Description	DIMENSÕES SIZE TAMAÑO (MM)			Quant. Min.
		A	W	H	
6873655	1.3/8" (35 mm) suporta até 20Kg	35	200	1	
6873755	2" (50 mm) suporta até 35Kg	50	85	1	
6873855	3" (75 mm) suporta até 55Kg	75	50	1	

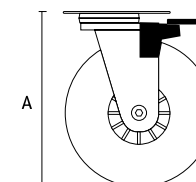

Rodízio fixo de pvc e poliuretano com freio

Fixed pvc and polyurethane brake caster with brake | Rodamiento fijo de pvc y poliuretano con freno



Barcode	Description	DIMENSÕES SIZE TAMAÑO (MM)			Quant. Min.
		A	W	H	
6874155	3" (75 mm) suporta até 50Kg	75	85	1	
6874255	4" (100 mm) suporta até 50Kg	100	50	1	

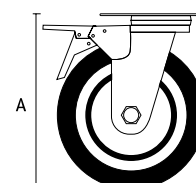

- Roda de PVC e poliuretano vermelho | PVC and red polyurethane wheel | Rueda de PVC y poliuretano rojo

Rodízio Fixo sem freio

Fixed caster without brake | Rodamiento fijo sin freno



Barcode	Description	DIMENSÕES SIZE TAMAÑO (MM)			Quant. Min.
		A	W	H	
6871055	5" (125 mm) suporta até 135 kg	125	30	1	
6871155	6.5/16" (160 mm) suporta até 150 kg	160	12	1	
6871255	8" (200 mm) suporta até 165 kg	200	8	1	
6872255	2" (50 mm) suporta até 27 kg	50	170	1	
6872355	4.1/2" (115 mm) suporta até 45 kg	115	80	1	
6872455	5.1/8" (130 mm) suporta até 55 kg	130	40	1	

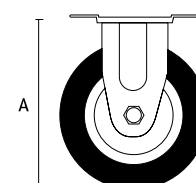

- Roda de borracha preta | Black Rubber Wheel | Rueda de goma negra



Cinto múltiplo porta ferramentas

Multi Tool Belt | Cinturón múltiple porta herramientas



902419



313g

DIMENSÕES | SIZE | TAMAÑO (MM)

A

B



40



1

AUTO SERVIÇO



Suporte ajustável | Adjustable stand | Soporte ajustable

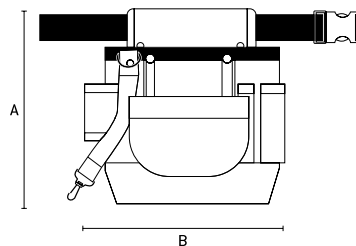

- Confeccionado em lona reforçada | Made of reinforced canvas | Confeccionado en lona reforzada
- Cinto ajustável em nylon com presilha de fixação | Adjustable nylon belt with locking tab | Cinturón ajustable en nylon con fijación de fijación
- Bolsa com 7 bolsos porta ferramentas | Bag with 7 tool holder pockets | Bolsa con 7 bolsillos porta herramientas
- Embalagem: Blister | Packing: Blister | Embalaje: Blister

Bolsa de ferramentas

Tool bag | Bolsa de herramientas



902429



413g

DIMENSÕES | SIZE | TAMAÑO (MM)

A

B



40



1

AUTO SERVIÇO

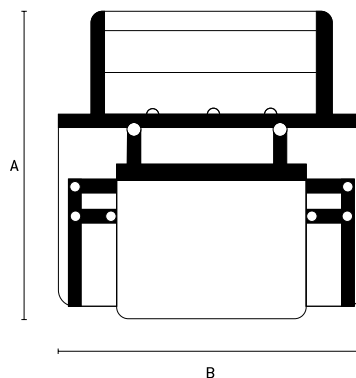

- Confeccionado em lona reforçada | Made of reinforced canvas | Confeccionado en lona reforzada
- Com 8 bolsos e suporte para martelo | With 8 pockets and hammer stand | Con 8 bolsillos y soporte para martillo
- Embalagem: Blister | Packing: Blister | Embalaje: Blister

Porta ferramentas

Toolholder | Puerta de herramientas



902439



322g

DIMENSÕES | SIZE | TAMAÑO (MM)

A

B



40



1

AUTO SERVIÇO

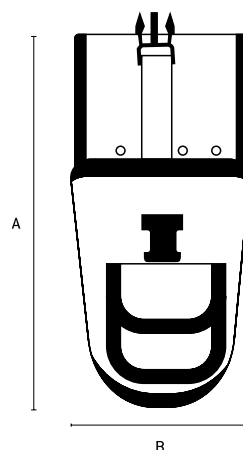

- Confeccionado em lona reforçada | Made of reinforced canvas | Confeccionado en lona reforzada
- Alça passante para cinto | Belt loop strap | Alza pasante para cinturón
- Bolsa com divisórias para furadeira, bits e brocas | Bag with drill, bits and bit dividers | Bolsa con separadores para taladro, bits y brocas
- Não acompanha cinto | Does not include a belt | No acompaña cinturón
- Embalagem: Blister | Packing: Blister | Embalaje: Blister

Cinto porta ferramentas

Tool Belt | Cinturón porta herramientas

AUTO
SERVIÇO



902479	810 - 1120mm	125g	DIMENSÕES SIZE TAMAÑO (MM)		72	Quant. Min.
			A	B		

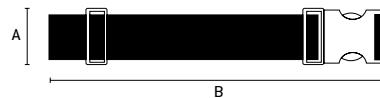

- Confeccionado em lona reforçada | Made of reinforced canvas | Confeccionado en lona reforzada
- Embalagem: Blister | Packing: Blister | Embalaje: Blister

Bolsa e acessórios para ferramentas

Tool bag and accessories | Bolsa y accesorios para herramientas



902569	1235g	DIMENSÕES SIZE TAMAÑO (MM)		12	Quant. Min.
		A	B		

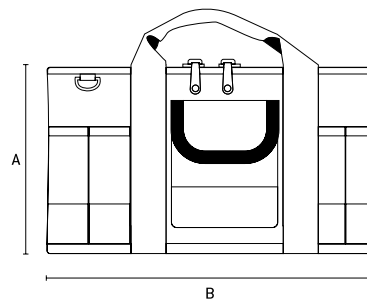

- Confeccionado em lona reforçada | Made of reinforced canvas | Confeccionado en lona reforzada
- Cinto ajustável em nylon com presilha de fixação | Adjustable nylon belt with locking tab | Cinturón ajustable en nylon con presilla de fijación
- Bolsa com 32 bolsos porta ferramentas | Bag with 32 tool holder pockets | Bolsa con 32 bolsillos porta herramientas
- Embalagem: Blister | Packing: Blister | Embalaje: Blister

Bolsa e acessórios para ferramentas

Tool bag and accessories | Bolsa y accesorios para herramientas



902529	1331g	DIMENSÕES SIZE TAMAÑO (MM)		12	Quant. Min.
		A	B		

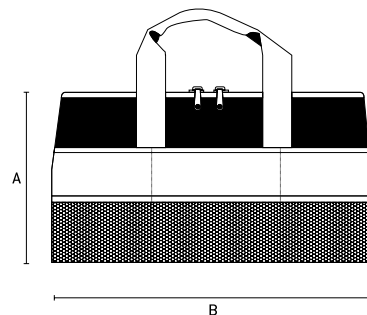

- Confeccionado em lona Made of canvas | Confeccionado en lona
- Alça reforçada de nylon | Reinforced nylon strap | Alza reforzada de nylon
- Bolsa com 18 bolsos porta ferramentas | Bag with 18 tool holder pockets | Bolsa con 18 bolsillos porta herramientas
- Reforço na parte superior e inferior | Reinforced nylon strap | Alza reforzada de nylon
- Zíper extrareforçado | Reinforced nylon strap | Alza reforzada de nylon
- Embalagem: Blister | Packing: Blister | Embalaje: Blister



Colete porta ferramentas

Tool holder vest | Chaleco porta herramientas

AUTO SERVIÇO



902469



608g

DIMENSÕES | SIZE | TAMAÑO (MM)

A

B



12



1

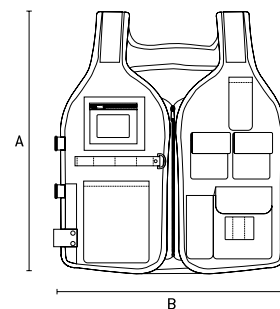

- Confeccionado em lona reforçada com forro | Made of canvas reinforced with lining | Confeccionado en lona reforzada con forro
- Zíper reforçado e ajuste lateral de tamanho | Reinforced zipper and side size adjustment | Zíper reforzado y ajuste lateral de tamaño
- Embalagem: Caixa | Packing: Box | Embalaje: Caja

Maçarico

Blowtorch | Soplete



BLISTER



914249



222g

DIMENSÕES | SIZE | TAMAÑO (MM)

A

B



72



12

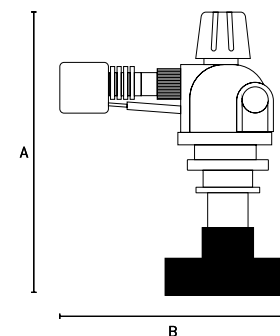

- Bico padrão | Standard nozzle | Boquilla estándar
- Acendimento automático | Automatic ignition | Encendido automático
- Embalagem: Blister | Packing: Blister | Embalaje: Blister

Maçarico

Blowtorch | Soplete



BLISTER



914269



396g

DIMENSÕES | SIZE | TAMAÑO (MM)

A

B



48



8

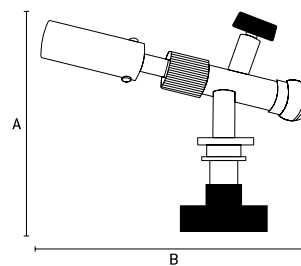

- Bico padrão | Standard nozzle | Boquilla estándar
- Bico estendido, metal | Extended nozzle, metal | Boquilla extendida, metal
- Acendimento automático | Automatic ignition | Encendido automático
- Embalagem: Blister | Packing: Blister | Embalaje: Blister

Maçarico

Blowtorch | Soplete



BLISTER



914279



306g

DIMENSÕES | SIZE | TAMAÑO (MM)

A

B



72



12

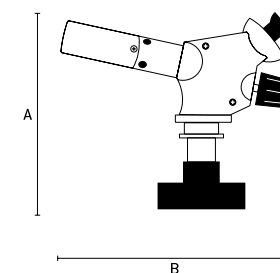

- Bico padrão | Standard nozzle | Boquilla estándar
- Bico estendido, metal | Extended nozzle, metal | Boquilla extendida, metal
- Acendimento automático | Automatic ignition | Encendido automático
- Embalagem: Blister | Packing: Blister | Embalaje: Blister

Afiador de brocas

Sharpening drills | Afilador de brocas



antigo	novo					
912305	9123055	3,5 a 10mm	435g	A 200	B 223	12 1



BLISTER

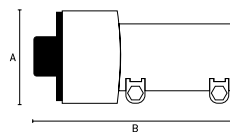

Para ser utilizado com furadeira |
To be used with a drill |
Para ser utilizado con taladro

- Indicado para brocas com um diâmetro de 43mm de área de corte |
Indicated for drills with a diameter of 43mm of cut area |
Indicado para brocas con un diámetro de 43mm de área de corte
- Embalagem: Blister | Packing: Blister | Embalaje: Blister

Porta eletrodo

Electrode holder | Puerta electrodo



9145355	300 amperes amps amperios	252g	A 75	B 225	50 1
9145555	500 amperes amps amperios	308g	85	240	50 1

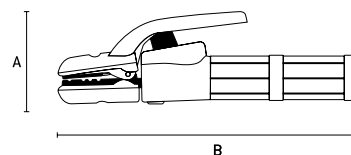

Suporte para furadeira

Drill stand | Soporte para taladro



9340555	2700g	A 430	B 215	48	12

Suporte ajustável
Adjustable stand
Soporte ajustable

Morça com ajuste
Vise with adjustment
Morsa con ajuste

Base Ajustável
Adjustable Base
Base ajustable



Trava Cabo de Aço

Locks Steel Cable | Bloqueos Cable de Acero

AUTO SERVIÇO



918149	146g	DIMENSÕES SIZE TAMAÑO (MM)		120	1
		A	B		
918169	185g	8	1200	60	1

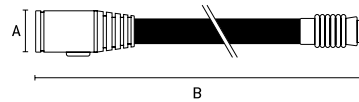

- Cabo de aço flexível em uma capa plástica protetora | Flexible steel cable in a protective plastic cover | Cable de acero flexible en una capa plástica protectora
- Mecanismo secreto (larvas) em latão | Secret mechanism (larvae) in brass | Mecanismo secreto (larvas) en latón
- Bloqueio automático | Automatic blocking | Bloqueo automático
- Inclui duas chaves de aço | Includes two steel wrenches | Incluye dos llaves de acero

Trava Cabo de Aço

Locks Steel Cable | Bloqueos Cable de Acero

AUTO SERVIÇO



918189	273g	DIMENSÕES SIZE TAMAÑO (MM)		48	1
		A	B		
		10	950		

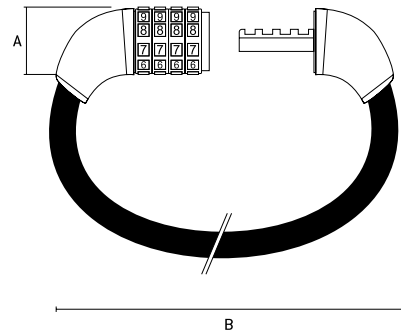

- Cabo de aço flexível em uma capa plástica protetora | Flexible steel cable in a protective plastic cover | Cable de acero flexible en una capa plástica protectora
- Fechadura de combinação | Combination lock | Cerradura de combinación

INFORMAÇÕES

Information | Información



INFORMAÇÕES GERAIS

General information
Informaciones generales

- **ÍNDICE ALFABÉTICO**
ALPHABETICAL INDEX | ÍNDICE ALFABÉTICO
- **TABELAS DE CONVERSÕES**
CONVERSION TABLES | TABLAS DE CONVERSIONES
- **SIMBOLOGIA TÉCNICA**
TECHNICAL SYMBOLS | SIMBOLOGÍA TÉCNICA

Fotos dos produtos | Product Photos | Fotos de los productos

- **Algumas fotos ou imagens contidas neste catálogo são meramente ilustrativas.**

Some photos or images contained in this catalog are merely illustrative.

Algunas fotos o imágenes contenidas en este catálogo son meramente ilustrativas.

Alterações / modificações de produtos | Product changes / modifications | Cambios / modificaciones de productos

- **A Toolsworld reserva-se no direito de alterar qualquer um dos itens contidos neste catálogo, com o objetivo de melhorá-los ou sempre que existam razões técnicas ou comerciais para isto. Qualquer alteração que vier a ser efetivada está isenta de aviso prévio e não obriga à modificação das unidades já vendidas.**

Toolsworld reserves the right to change any of the items contained in this catalog for the purpose of improving them or whenever there are technical or commercial reasons for doing so.

Any changes that may be made are exempt from prior notice and do not require the modification of units already sold.

Toolsworld se reserva el derecho de cambiar cualquiera de los elementos contenidos en este catálogo, con el fin de mejorarlos o siempre que existan razones técnicas o comerciales para ello.

Cualquier alteración que se esté realizando está exenta de aviso previo y no obliga a la modificación de las unidades ya vendidas.

Cancelamento ou retirada de produção | Cancellation or withdrawal of production | Cancelación o retirada de producción

- **A Toolsworld reserva-se no direito de retirar de produção ou anular a comercialização de qualquer item presente neste catálogo.**

Toolsworld reserves the right to withdraw from production or void the marketing of any item in this catalog.

Toolsworld se reserva el derecho de retirar de producción o anular la comercialización de cualquier artículo presente en este catálogo.

Medidas e Pesos | Measures and Weights | Medidas y Pesos

- **Os valores relativos a pesos e medidas contidos neste catálogo são sujeitos a alterações.**

The values for weights and measures contained in this catalog are subject to change.

Los valores relativos a pesos y medidas contenidos en este catálogo están sujetos a cambios.



ÍNDICE ALFABÉTICO

ALPHABETICAL INDEX | INDICE ALFABÉTICO

A



PRODUTOS	TRADUÇÃO	MARCA	LANÇAMENTOS	PAG.
Abraçadeira	Clamp Abrazadera	PALISAD		149
Abraçadeira rosca sem fim	Endless threaded clamp Abrazadera rosca sin fin	SPARTA		123
Adaptador	Universal joint Junta universal	STELS	2019	108
Adaptador Flexível	Flexible Adapter Adaptador Flexible	GROSS		106
Adaptador para boina	Adapter for beret Adaptador para boina	MTX	2019	174
Adaptador para mandril	Adapter for mandrel Adaptador para mandril	MTX		160
Afiador de brocas	Sharpening drills Afilador de brocas	SPARTA		215
Afiador de facas	Knife sharpener Afilador de cuchillos	MTX		197
Afiador de facas	Knife sharpener Afilador de cuchillos	MTX		197
Alicate Bico Meia-Cana Curvo Mini	Pliers Beak Half-Cane Curved Mini Pinza Punta Media-Canã Curvo Mini	SPARTA		52
Alicate Bico Meia-Cana Curvo Nickel	Pliers Beak Half-Cane Curved Nickel Pinza Punta Media-Canã Curvo Nickel	MTX		49
Alicate Bico Meia-Cana Reto	Pliers Beak Half-Cane Straight Pinza Punta Media-Canã Reto	GROSS	2019	48
Alicate Bico Meia-Cana Reto Black Nickel	Pliers Beak Half-Cane Straight Black Nickel Pinza Punta Media-Canã Reto Black Nickel	MTX		50
Alicate Bico Meia-Cana Reto Mini	Pliers Beak Half-Cane Straight Mini Pinza Punta Media-Canã Reto Mini	SPARTA		52
Alicate Bico Meia-Cana Reto Nickel	Pliers Beak Half-Cane Straight Nickel Pinza Punta Media-Canã Reto Nickel	MTX		49
Alicate Bico Meia-Cana Reto VDE	Pliers Beak Half-Cane Straight VDE Pinza Punta Media-Canã Reto VDE	MTX		51
Alicate bomba d'água	Tile Pincers Tenaza para azulejo	SPARTA		55
Alicate bomba d'água	Tile Pincers Tenaza para azulejo	MTX		55
Alicate Corte Diagonal (150mm)	Diagonal Cutting Pliers Pinza Corte Diagonal	GROSS	2019	48
Alicate Corte Diagonal Black Nickel	Diagonal Cutting Pliers Black Nickel Pinza Corte Diagonal Black Nickel	MTX		50
Alicate Corte Diagonal Mini	Diagonal Cutting Pliers Mini Pinza Corte Diagonal Mini	SPARTA		52
Alicate Corte Diagonal Nickel	Diagonal Cutting Pliers Nickel Pinza Corte Diagonal Nickel	MTX		49
Alicate Corte Diagonal VDE	Diagonal Cutting Pliers VDE Pinza Corte Diagonal VDE	MTX		51
"Alicate Crimpador Catracado Para Cabos RJ11, RJ12 e RJ45"	"Caught catching cranket for RJ11, RJ12 and RJ45 cables Alicate crimpador catracado para cables RJ11, RJ12 y RJ45"	GROSS		58
Alicate de Pressão Bico Chato	Flat Tip Pliers Alicate de Presión Boquilla Chato	MTX	2019	60
Alicate de Pressão Mordente Curvo	Curved Cheek Pressure Pliers Alicate de Presión Mordente Curvo	MTX	2019	59
Alicate de Pressão Mordente Curvo Reto	Curved Cheek Pressure Pliers Alicate de Presión Mordente Curvo	MTX	2019	59
Alicate de Pressão Mordente Longo	Long Cheek Pressure Pliers Alicate de Presión Mordente Largo	MTX	2019	59
Alicate de Pressão Mordente Reto	Pressure Munching Pliers Alicate de Presión Mordente Recto	MTX	2019	59
Alicate de Pressão Mordente Tipo C	Type U Munch Pressure Pliers Alicate de presión Mordente Tipo U	MTX	2019	60
Alicate de Pressão Tipo Corrente	Current Type Pressure Pliers Alicate de presión tipo corriente	MTX	2019	60
Alicate externo Bico Curvo	External pliers Beak Curved Pinza externa Punta curva	SPARTA		54
Alicate externo Bico Reto	External pliers Beak Reto Pinza externa Punta Reto	SPARTA		54
Alicate interno Bico Curvo	Internal pliers Beak Curved Pinza interna Punta curva	SPARTA		54
Alicate interno Bico Reto	Internal pliers Beak Reto Pinza interna Punta Reto	SPARTA		54
Alicate punçador para drywall	Pliers punch for drywall Alicate punzonador para drywall	MTX		204
Alicate Universal Mini	Universal pliers Mini Alicate Universal Mini	SPARTA		52
Alicate Universal Combinada(210mm)	Universal Combination Pliers Alicate Universal Combinado	GROSS	2019	48
Alicate Universal Nickel	Universal pliers Nickel Alicate Universal Nickel	MTX		49
Alicate Universal Nickel	Universal pliers Nickel Alicate Universal Nickel	MTX		50
Alicate Universal VDE	Universal pliers Nickel Alicate Universal Nickel	MTX		51
Almotolia metálica	Metal almotolia Almotolia metálica	SPARTA		122
Ancinho / Rastelo	Creep / Rake Rastrillo / Rizo	PALISAD		135
Ancinho / Rastelo	Creep / Rake Rastrillo / Rizo	PALISAD		135
Ancinho / Rastelo	Creep / Rake Rastrillo / Rizo	PALISAD		135
Ancinho / Rastelo	Creep / Rake Rastrillo / Rizo	PALISAD		138
Ancinho / Rastelo	Creep / Rake Rastrillo / Rizo	PALISAD		139



PRODUTOS	TRADUÇÃO	MARCA	LANÇA MENTOS	PAG.
Acinho / Rastelo	Creep / Rake Rastrillo / Rizo	PALISAD		140
Aplicador de silicone	Silicone applicator Aplicador de silicona	SPARTA		208
Aplicador de silicone	Silicone applicator Aplicador de silicona	SPARTA		208
Aplicador metálico de silicone	Silicone metal applicator Aplicador metálico de silicona	SPARTA		208
Arco de serra	Saw arch Arco de sierra	SPARTA		195
Arco de serra	Saw arch Arco de sierra	SPARTA		195
Arco de serra	Saw arch Arco de sierra	MTX		195
Arrancador de Ervas Daninhas	Pluck herbs Arrancador de hierbas	PALISAD		139

B



PRODUTOS	TRADUÇÃO	MARCA	LANÇA MENTOS	PAG.
Balde	Bucket cubo	PALISAD		142
Bits / Ponteira - 1/4"	Bits / Tips - 1/4" Bits / Ponteira - 1/4"	MTX		28
Bolsa de ferramentas	Tool bag Bolsa de herramientas	MTX		212
Bolsa e acessórios para ferramentas	Tool bag and accessories Bolsa y accesorios para herramientas	MTX		213
Bolsa e acessórios para ferramentas	Tool bag and accessories Bolsa y accesorios para herramientas	MTX		213
Bolsa térmica de poliéster	Polyester thermal bag Bolsa térmica de poliéster	PALISAD		152
Bordas para jardim	Garden borders Bordes para jardín	PALISAD		141
Bordas para jardim	Garden borders Bordes para jardín	PALISAD		141
Broca bailarina	Drill for wood Broca para madeira	MTX		156
Broca chata para madeira	Flat boring drill Broca plana para madeira	MTX		155
Broca de concreto SDS Plus	Concrete drill bit Broca de concreto	MTX		160
Broca Escalonada HSS	HSS Stepper Drill Broca Escalada HSS	MTX	2019	166
Broca espiral para madeira	Spiral drill for wood Taladro espiral para madeira	MTX		154
Broca Foster para madeira	Foster Wood Drill Broca Foster para madeira	MTX		155
Broca guia para serra copo	Guide saw drill bit Broca guia para Sierra de agujero	MTX		158
Broca HSS Industrial	HSS Industry Drill Broca HSS Industrial	MTX		163
Broca HSS Professional	HSS Professional Drill Broca HSS Professional	MTX		164
Broca HSS Profissional	HSS Professional Drill Broca HSS Professional	MTX		162
Broca HSS Profissional	HSS Professional Drill Broca HSS Professional	MTX		163
Broca HSS Standard	HSS Standard Drill Broca HSS Estándar	MTX		163
Broca HSS Standard/ Aço rápido polido	"HSS Standard Drill / Polished Rapid Steel Broca HSS Estándar / Acero rápido pulido"	MTX		162
Broca para Concreto	Concrete drill Broca para concreto	MTX		161
Broca para concreto - Golden Line	Concrete drill - Golden line Taladro para hormigón - Golden Line	MTX		160
Broca para Concreto SDS Max	Concrete drill Broca para concreto	MTX		161
Broca para Concreto SDS Plus	Concrete drill Broca para concreto	MTX		161
Broca para porcelanato	Porcelain drill bit Broca para porcelana	MTX		167

C



PRODUTOS	TRADUÇÃO	MARCA	LANÇA MENTOS	PAG.
Cabo de força "T"	Power cable "T" Cable de fuerza "T"	MTX		109
Cabo de força "T"	Power cable "T" Cable de fuerza "T"	STELS	2019	109
Cabo de força articulado 1/2" quadrado	Extensions 1/2 "square Extensiones 1/2 "cuadradas	MTX		107
Cabo de transmissão de carga de bateria	Battery charge transmission cable Cable de transmisión de carga de batería	STELS	2019	123
Cabo telescópico	Telescopic cable Mango telescópico	MTX		201
Caixa de bits /Ponteira 50mm	Bit set Box / Tip 50mm Caja de bits / Puntera 50mm	MTX		22
Caixa de bits /Ponteira Multidentada	Bit set Box Multidentate / Tip Caja de bits / Puntera Multidentate	STELS		32
Caixa de bits /Ponteira Multidentada	Bit set Box Multidentate / Tip Caja de bits / Puntera Multidentate	STELS		33

PRODUTOS	TRADUÇÃO	MARCA	LANÇAMENTOS	PAG.
Caixa de bits /Ponteira Sextavado	Bit set Box Sixth grade / Tip Caja de bits / Puntera hexagonal	STELS		32
Caixa de bits /Ponteira Torx	Bit set Box Torx / Tip Caja de bits / Puntera Torx	STELS		33
Caixa Plástica meia esquadria	Plastic housing half miter Caja Plástica media escuadra	SPARTA		69
Caixa Plástica para serra meia esquadria	Plastic box for half miter saws Caja Plástica para sierra media escuadra	MTX		69
Calibrador de Pneus	Tire Calibrator Calibrador de Neumáticos	STELS		125
Canivete	Switchblade Cortaplumas	SPARTA		197
Canivete para jardim	Garden Knife Cuchillo para jardín	PALISAD		130
Carretel de linha com giz para drywall	Spool line with drywall chalk Carrete de línea con tiza para drywall	MTX		201
Chave de grifo em alumínio	Griffin key aluminum Llave de grifo de aluminio	MTX		40
Chave de grifo Inclinado	Inclined Griffin key Llave de grifo Inclinado	MTX		40
Chave de grifo Modelo Heavy Duty	Pipe wrench Heavy Duty Model Llave de grifo Modelo Heavy Duty	MTX		40
Chave de grifo tipo "S"	Pipe wrench type " S " Clave de grifo tipo " S "	MTX		39
Chave de grifo tipo Stillson	Pipe wrench Type Stillson Llave de grifo tipo Stillson	SPARTA		40
Chave Inglesa cabo emborrachado	Wrench Rubber Cable Llave de cable de cobre	MTX		39
Chave Inglesa Cromada	Chrome Plated Wrench Llave Inglesa Cromada	SPARTA		39
Chave Combinada	Combined key Llave Combinada	STELS		115
Chave Combinada	Combined key Llave Combinada	SPARTA		113
Chave Combinada	Combined key Llave Combinada	STELS		114
Chave Combinada	Combined key Llave Combinada	MTX		115
"Chave Combinada com catraca articulada"	"Combination wrench with articulated ratchet Llave Combinada con trinquete articulado"	MTX		115
Chave Combinada com catraca	Combination wrench with ratchet Llave Combinada con trinquete	MTX		115
Chave de Biela	Connecting rod wrench Llave de Biela	STELS		112
"Chave de bits com alça ergonômica em forma de T"	"Bit key with T-shaped ergonomic handle Llave de bits con mango ergonómico en forma de T"	MTX		30
Chave de bits com catraca reversível	Reversible ratchet bit key Llave de bits con trinquete reversible	SPARTA		29
Chave de bits reversível com dobradiça	Reversible bit key with hinged Llave de bits reversible con bisagra	SPARTA		29
Chave de catraca	Ratchet wrench Llave de trinquete	SPARTA		109
Chave de catraca	Ratchet wrench Llave de trinquete	MTX		109
Chave de catraca	Ratchet wrench Llave de trinquete	MTX		109
Chave de catraca	Ratchet wrench Llave de trinquete	STELS		110
Chave de catraca Teflonada	Teflon Ratchet wrench Llave de trinquete Teflón	STELS		110
Chave de catraca Teflonada	Teflon Ratchet wrench Llave de trinquete Teflón	GROSS		110
Chave de corrente	Power switch Llave de corriente	SPARTA		122
Chave de Fenda Especialista	Screwdriver Destornillador	SPARTA		34
Chave de Fenda/Phillips	Screwdriver / Phillips Destornillador / phillips	SPARTA		30
Chave de impacto rotativo - 7pçs	Rotary impact wrench - 7pcs Llave de impacto rotativo - 7pzs	MTX		31
Chave de Roda	Wheel Wrench Llave de Rueda	MTX		112
Chave de Roda	Wheel Wrench Llave de Rueda	GROSS		112
Chave de Roda em Cruz	Cross Wheel Wrench Llave de Rueda en Cruz	STELS	2019	112
Chave de Roda Montável	Wheel Wrench Llave de Rueda	GROSS		113
Chave de Roda Tipo L	Type L Wheel Wrench Llave de Rueda Tipo L	STELS	2019	112
Chave de Teste	Test Key Clave de prueba	SPARTA		123
Chave Estrela	Star key Clave estrella	STELS		114
Chave Estrela	Star key Clave estrella	SPARTA		113
Chave estrela com catraca	Fixed wrench with ratchet Llave fija con tornillo	MTX		114
Chave Fixa	Fixed key Clave fija	STELS		113
Chave Fixa	Fixed key Clave fija	SPARTA		113
Chave para Mandril	Chuck wrench Llave para Mandril	MTX		45
Chave Phillips Ponta imantada	Phillips head Magnetic tip Llave Phillips Extremidad imantada	MTX		34
"Chave reversível com bits/ponteira/soquetes-16pçs"	"Reversible switch with bits/bushing/sockets-16pcs Llave reversible con bits/puntera/enchufe-16pzs"	MTX		30



PRODUTOS	TRADUÇÃO	MARCA	LANÇAMENTOS	PAG.
Chave Starter	Starter wrench Llave Starter	STELS		120
Chave suporte para soquetes	Anatomical cable for sockets Cabo anatómico para soquetes	MTX		108
Chave suporte para soquetes	Socket wrench holder Llave de soporte para sockets	STELS		108
Chave Teste 140mm	teste Key 140mm Llave Test 140mm	SPARTA		36
Chave Teste 190mm	teste Key 190mm Llave Test 190mm	SPARTA		36
Chaves Allen Curta fosfatizada	Allen Key Phosphatized Chaves Allen fosfatizado	MTX	2019	15
Chaves Allen Longa Abaulada fosfatizada	Allen Key Long Phosphatized Chaves Allen Larga fosfatizado	MTX	2019	15
Chaves Fenda / Phillips Série Cabo Verde	"Screwdrivers / Key Phillips - Point Series Llaves Destornillador / Phillips - Serie Point"	MTX		35
Chaves Fenda / Phillips Série Point	"Screwdrivers / Key Phillips - Point Series Llaves Destornillador / Phillips - Serie Point"	SPARTA		35
Chaves TORX curta fosfatizada com guia	TORX Key Phosphatized Chaves TORX fosfatizado	MTX	2019	15
Chaves TORX longa fosfatizada com guia	TORX Key Long Phosphatized Chaves TORX Larga fosfatizado	MTX	2019	15
Chaves VDE	VDE Keys Llaves VDE	MTX		34
Cinta para amarração de carga	Load lashing strap Cinta de amarre de carga	STELS		120
Cinta para amarração de carga	Load lashing strap Cinta de amarre de carga	STELS		120
Cinto múltiplo porta ferramentas	Multi Tool Belt Cinturón múltiple porta herramientas	MTX		212
Cinto porta ferramentas	Tool Belt Cinturón porta herramientas	MTX		213
Colete porta ferramentas	Tool holder vest Chaleco porta herramientas	MTX		214
Colher de pedreiro OVAL	OVAL Trowel Cuchara de albañil OVAL	MTX		200
Colher de pedreiro RETA	Straight trowel spoon Cuchara de albañil recta	MTX		200
Cone para plantio	Cone for planting Cono de plantación	PALISAD		142
Conector de mangueira 1/2"	Hose connector Conector de manguera	PALISAD		145
Conector duplo para engate rápido	Double connector for quick coupling Conector doble para enganche rápido	PALISAD		147
Conector fêmea de plástico com bucha 3/4"	"Plastic female connector with bushing Conector hembra de plástico con casquillo"	PALISAD		145
Conector macho	Connector male Conector macho	PALISAD		147
Conector triplo para engate rápido	Triple connector for quick coupling Conector triple para acoplamiento rápido	PALISAD		144
Conector triplo para engate rápido	Triple connector for quick coupling Conector triple para enganche rápido	PALISAD		147
Conectores e adaptadores	Connectors & Adapters Conectores y adaptadores	PALISAD		146
Conectores e adaptadores	Connectors & Adapters Conectores y adaptadores	PALISAD		146
Conjunto de bits com limitador	Bit set with limiter Conjunto de bits con limitador	GROSS		26
Conjunto de bits PH2 70mm	Set of 70mm bits Conjunto de bits 70mm	GROSS		25
Conjunto de bits 25mm - 10 pçs	Set of 25mm bits - 10 pcs Conjunto de bits 25mm - 10 pzs	GROSS		24
Conjunto de bits 25mm - 2 peças	Set of 25mm bits - 2 parts Conjunto de bits 25mm - 2 piezas	GROSS		25
Conjunto de bits 50/ 70/90mm	Bit set 50/70/90mm Conjunto de bits 50/70/90mm	GROSS		25
Conjunto de bits 90mm - 10pçs	Set of 90mm bits 10pcs Conjunto de bits 90mm 10pzs	GROSS		24
Conjunto de bits adaptador magnético 50mm	Magnetic adapter bit set 50mm Conjunto de bits magnético 50mm	GROSS		26
Conjunto de bits de dois lados PH2 45mm	Double Sided Bits 45mm Conjunto de bits de dos lados 45mm	GROSS		24
Conjunto de Grampos em Forma de G	Set of G-shaped Clips Conjunto de grapas en forma de G	SPARTA		67
Cortador de cerâmica e azulejos	Ceramic and tile cutter Cortador de cerámica y azulejos	MTX		207
Cortador de cerâmica em círculo	Ceramic cutter in a circle Cortador de cerámica en círculo	MTX		207
Cortador de tubos de PVC	PVC pipe cutter Cortador de tubos de PVC	MTX		196
Cortador de vidro	Glass cutter Cortador de cristal	SPARTA		204
Cortador de vidro	Glass cutter Cortador de cristal	MTX		204
Cossinetes	Cossinetes Días	MTX		184

D



PRODUTOS	TRADUÇÃO	MARCA	LANÇAMENTOS	PAG.
Desencapador automático	Auto unplug Desengrasador automático	SPARTA		56
Desencapador de fios	Wire stripper Desengrasador de cables	SPARTA		56

PRODUTOS	TRADUÇÃO	MARCA	LANÇAMENTOS	PAG.
"Desencapador de fios automático com prensa para terminais"	"Automatic wire stripper with press for terminals Desencajador de hilos automático con prensa para terminales"	GROSS		57
Disco de corte Inox/ Metal	Stainless Steel Cutting Disc/Metal Disco de corte Inox/ Metal	GROSS		177
Disco de corte Inox/ Metal	Stainless Steel Cutting Disc/Metal Disco de corte Inox/ Metal	MTX		177
Disco de corte/ Metal	Cutting disc/ Metal Disco de corte/ Metal	MTX		177
Discos de corte diamantados	Diamond Cutting Discs Discos de corte diamantados	SPARTA		171
Discos de corte diamantados	Diamond Cutting Discs Discos de corte diamantados	MTX		171
Discos de corte diamantados	Diamond Cutting Discs Discos de corte diamantados	MTX		171
Discos de corte diamantados	Diamond Cutting Discs Discos de corte diamantados	SPARTA		172
Discos de corte diamantados	Diamond Cutting Discs Discos de corte diamantados	MTX		172
Discos de corte diamantados	Diamond Cutting Discs Discos de corte diamantados	MTX		172
Discos de corte diamantados	Diamond Cutting Discs Discos de corte diamantados	MTX		173
Discos de corte diamantados	Diamond Cutting Discs Discos de corte diamantados	MTX		173
Discos de corte diamantados	Diamond Cutting Discs Discos de corte diamantados	MTX		173
Discos de corte diamantados	Diamond Cutting Discs Discos de corte diamantados	SPARTA		174
Discos de desbaste	Roughing discs Discos de desbaste	MTX		176
Discos de desbaste "FLAP"	Roughing discs " FLAP " Discos de desbaste " FLAP "	GROSS		176
Discos de desbaste "FLAP" zirconio	Roughing discs " FLAP " zirconium Discos de desbaste " FLAP " zirconio	GROSS		176
Discos de lixa	Sanding discs Discos de lixa	MTX		175
Discos de lixa com velcro	Sanding discs with velcro Discos de lixa con velcro	MTX		175
Discos de serra circular	Circular Saw Blades Discos de sierra circular	MTX		170
Discos de serra circular - Alumínio	Circular Saw Blades Discos de sierra circular	MTX		170

E



PRODUTOS	TRADUÇÃO	MARCA	LANÇAMENTOS	PAG.
Emenda de mangueira	Hose attachment Enmienda de manguera	PALISAD		146
Engate rápido	Quick coupling Enganche rápido	PALISAD		145
Enxadinha	Small hoe Azada pequeño	PALISAD		137
Escardilho	Spud Escardilho	PALISAD		139
Escova de aço	Steel brush Cepillo de acero	SPARTA		182
Escova Manual	Hand brush Cepillo Manual	MTX		180
Escova manual	Hand brush Cepillo manual	SPARTA		181
Escova pincel	Steel Brush Cepillo Pincel	MTX		181
Escovas circulares	Circular Brushes Cepillos circulares	MTX		178
Escovas circulares	Circular Brushes Cepillos circulares	MTX		178
Escovas circulares	Circular Brushes Cepillos circulares	MTX		178
Escovas circulares	Circular Brushes Cepillos circulares	MTX		178
Escovas manuais	Hand brushes Cepillos manuales	MTX		181
Escovas manuais	Hand brushes Cepillos manuales	MTX		181
Escovas tipo copo	Cup Brushes Cepillos tipo vaso	MTX		179
Escovas tipo copo	Cup Brushes Cepillos tipo vaso	MTX		179
Escovas tipo copo	Cup Brushes Cepillos tipo vaso	MTX		179
Escovas tipo copo	Cup Brushes Cepillos tipo vaso	MTX		179
Esguicho Ajustável	Adjustable Spray Eschicho ajustable	PALISAD		145
Esguicho Pistola	Squirt Gun Eschicho Pistola	PALISAD		143
Esguicho Pistola	Squirt Gun Eschicho Pistola	PALISAD		143
Espaçador para piso, plástico	Floor spacer, plastic Espaciador de suelo, plástico	MTX		208
Espátula / Betumadeira de aço	Steel spatula Espátula de acero	SPARTA		203
Espátulas cabo de PVC	PVC cable spatulas Espátulas de mango de PVC	MTX		203
Esquadro	Square Escuadro	SPARTA		77
Esquadro Combinado (Uso Industrial)	Combined Square (Industrial Use) Escuadrón Combinado (Uso Industrial)	SPARTA		77

PRODUTOS	TRADUÇÃO	MARCA	LANÇA MENTOS	PAG.
Esquadro de Aço carbono	Carbon Steel Square Escuadra de acero carbono	MTX		77
Esquadro de alumínio fundido	Cast Aluminum Square Escuadra de aluminio fundido	MTX		77
Estiletes	Stiletto Estiletes	GROSS		186
Estiletes	Stiletto Estiletes	GROSS		186
Estiletes	Stiletto Estiletes	GROSS		186
Estiletes	Stiletto Estiletes	MTX		187
Estiletes	Stiletto Estiletes	MTX		187
Estiletes	Stiletto Estiletes	MTX		187
Estiletes	Stiletto Estiletes	MTX		187
Estiletes	Stiletto Estiletes	SPARTA		188
Estiletes	Stiletto Estiletes	SPARTA		188
"Estojo de Chaves Allen de 9 peças abaulada"	"Allen key case - 9 peices Round edge Estuche de llaves Allen 9 piezas Punta Redonda "	MTX		21
Estojo de Chaves Allen de 9 peças	Allen key case - 9 peices Estuche de llaves Allen 9 piezas	MTX		20
"Estojo de Chaves Allen HEX/Torx de 18 peças"	"Allen HEX/Torx key case - 18 peices Estuche de Llaves Allen HEX/Torx de 18 piezas"	MTX		20
Estojo de Chaves Torx de 9 peças	Torx key case - 9 peices Estuche de Chaves Torx de 9 piezas	MTX		21
Extensão Flexível 1/4"	Flexible Extension-1/4" Extensión Flexible-1/4"	STELS		107
Extensões	Extensions Extensiones	STELS		106
Extensões	Extensions Extensiones	MTX		106
Extensões abaulada	Extensions bulging Extensiones abombadas	MTX		107
Extrator de ervas	Herbal extractor Extractor de hierbas	PALISAD		136
Extrator de ervas daninhas	Weed extractor Extractor de malas hierbas	PALISAD		136
Extrator de grampos	Staple Remover Extractor de grapas	MTX		90

F



PRODUTOS	TRADUÇÃO	MARCA	LANÇA MENTOS	PAG.
Filtro de ar comprimido	Compressed air filter Filtro de aire comprimido	MTX		124
Fita adesiva	Scotch tape Cinta adhesiva	MTX		205
Formão cabo plástico	Plastic cable chisel Cincel mango de plástico	SPARTA		71
Formões cabo plástico com borracha	Plastic Rubber Cable Chisel Formones mango de plástico con caucho	MTX		71
Funil plástico	Plastic funnel Embudo plástico	SPARTA		123

G



PRODUTOS	TRADUÇÃO	MARCA	LANÇA MENTOS	PAG.
Garfo 3 dentes	3-prong fork Cuello 3 dientes	PALISAD		135
Gazebo de poliéster estrutura articulada	Polyester Gazebo articulated structure Gazebo de poliéster estructura articulada	PALISAD	2019	151
Gazebo de poliéster estrutura articulada	Polyester Gazebo articulated structure Gazebo de poliéster estructura articulada	PALISAD	2019	151
"Grampeador e Pinador manual - Profissional"	"Stapler and Manual Pincher - Professional Grapadora y Pinador manual - Profesional"	MTX		88
Grampeador Manual	Manual Stapler Grapadora manual	SPARTA		89
Grampeador Pneumático	Pneumatic Stapler Grapadora Neumática	MTX		92
Grampeador Tapeceiro	Stapler Upholsterer Grapadora Tapicerí	MTX		88
Grampeador Tapeceiro Controle de Pressão	Stapler Upholsterer Pressure Control Grapadora Tapicería Control de Presión	MTX		88
Grampeador Tapeceiro de plástico	Stapler Upholsterer Aluminum Grapadora Tapicería de Aluminio	MTX		89
Grampo Angular	Angular Cleat Grapa Angular	SPARTA		66
Grampo em Forma de G	G-shaped clip Grapa en forma de G	MTX		67
Grampo em Forma de G Ajustável	G-shaped clip Adjustable Grapa en forma de G ajustable	MTX		67
Grampo em Forma de G Pintado	G-shaped clip Painted Grapa en forma de G pintado	SPARTA		67
Grampo Multiuso para Marceneiro	Multipurpose Clip for Handyman Grapa Multiuso para carpintero	MTX	2019	66
Grampo Sargento Aperto Rápido	Staple Sergeant Quick Tight Grapa Sargento Apriete Rápido	MTX		66

PRODUTOS	TRADUÇÃO	MARCA	LANÇA MENTOS	PAG.
Grampo Sargento Tipo F	Staple Sergeant Type F Grapa Sargento Tipo F	MTX		66
Grampos	Bobby pins Clips	MTX		91
Grampos	Clamp Grapa	MTX		90

H



PRODUTOS	TRADUÇÃO	MARCA	LANÇA MENTOS	PAG.
Haste para suporte serra copo	Stem to support cup saw Vástago para soporte Sierra de agujero	MTX		168

I



PRODUTOS	TRADUÇÃO	MARCA	LANÇA MENTOS	PAG.
Irrigador Múltiplo	Multiple Irrigator Irrigador Múltiple	PALISAD		148
Irrigador rotativo de plástico	Plastic Rotary Irrigator Irrigador giratorio de plástico	PALISAD		148
Irrigador setorial - tipo espiga	Sectorial irrigator - spike type Irrigador sectorial - tipo espiga	PALISAD		148

J



PRODUTOS	TRADUÇÃO	MARCA	LANÇA MENTOS	PAG.
Jarreteira para jardim	Garden Garter Jarretera para jardín	PALISAD		142
Jogo de Chaves Fenda / Phillips	Phillips / Screwdrivers Set Juego de Llaves Destornillador / Phillips	SPARTA		34
Jogo de acessórios para compressores	Accessory set for compressors Juego de accesorios para compresores	STELS		125
Jogo de Bits e Brocas	Set of Bits and Drills Juego de Bits y Brocas	MTX		167
Jogo de Bits/Ponteiras 18pçs	Bits / Tips Set 18pcs Juego de Bits / Puntas 18pçs	MTX		28
Jogo de Bits/Ponteiras 7pçs	Bits / Tips Set 7pc Juego de Bits / Puntas 7pç	MTX		26
Jogo de Broca para Concreto - Golden Line	Drill Set for Concrete - Golden line Juego de Broca para Concreto - Golden Line	MTX		160
Jogo de broca para fechadura	Drill for wood Broca para madeira	MTX	2019	158
Jogo de brocas chatas para madeira	Set of boring wood drills Juego de brocas para madeira	SPARTA		155
Jogo de brocas de 3 pontas para madeira	Set of 3-prong drill bits for wood Juego de brocas de 3 puntas para madeira	SPARTA		154
Jogo de brocas longa para madeira	Set of long drills for wood Juego de fresas largas para madeira	SPARTA		154
Jogo de Brocas para metal	Set of Metal Drills Juego de Brocas para metal	MTX		165
Jogo de Brocas para metal	Set of Metal Drills Juego de Brocas para metal	MTX		165
Jogo de chave Combinada	Combined key set Juego de clave Combinada	STELS		120
Jogo de chave Combinada	Combined key set Juego de clave Combinada	MTX		116
Jogo de Chave de catraca 11 peças	11 Piece Ratchet Wrench Set Juego de llave de trinquete 11 piezas	STELS		110
Jogo de chave estrela	Set of keys Star Juego de llave Estrella	STELS		117
Jogo de chave fixa	Fixed key set Juego de llave fija	MTX		116
Jogo de chave fixa	Fixed key set Juego de llave fija	STELS		117
Jogo de Chaves Allen de 9 peças acetinado	Satin Allen key set - 9 peices Juego de Chaves Allen de 9 piezas satinado	MTX		17
Jogo de Chaves Allen de 9 peças fosfatizado	"Allen Key Set - 9 peices Phosphatized Juego de Chaves Allen de 9 piezas fosfatizado"	MTX		16
Jogo de Chaves de Precisão 6pçs	Precision Key Set 6pcs Juego de llaves de precisión 6pzs	SPARTA		37
Jogo de Chaves de Precisão 6pçs	Precision Key Set 6pcs Juego de llaves de precisión 6pzs	GROSS		37
Jogo de Chaves de Precisão imantado - 8pçs	Precision Key Set magnetized - 8pcs Juego de llaves de precisión imantado - 8pzs	MTX		37
Jogo de conexão para mangueira	Set of connections for hose Juego de conexiones para la manguera	PALISAD		144
Jogo de engate rápido	Quick coupling kit Juego de acoplamiento rápido	STELS		124
Jogo de escovas	Set of brushes Juego de cepillos	MTX		180
Jogo de escovas circulares onduladas	Set of circular wavy brushes Juego de cepillos circulares ondulados	MTX		180
Jogo de escovas circulares onduladas	Set of circular wavy brushes Juego de cepillos circulares ondulados	MTX		180
Jogo de estiletes	Stiletto set Juego de estiletes	MTX		189
Jogo de estiletes	Stiletto set Juego de estiletes	MTX		189
Jogo de Ferramentas	Tool Set Juego de herramientas	MTX		31



PRODUTOS	TRADUÇÃO	MARCA	LANÇAMENTOS	PAG.
Jogo de Ferramentas de montagem 40pçs	Mounting Tools Set 40pcs Juego de herramientas de montaje 40pzs	SPARTA		38
Jogo de Ferramentas para Bancada 129pçs	Bench Top Tool Set 129pcs Juego de herramientas para banco 129pzs	SPARTA		38
Jogo de Ferramentas para Bancada 6pçs	Bench Top Tool Set 6pcs Juego de herramientas para banco 6pzs	SPARTA		38
Jogo de Ferramentas/18pçs	Tool Set-18pcs Juego de Herramientas-18pzs	STELS		101
Jogo de Ferramentas/24pçs	Tool Set - 24pcs Juego de Herramientas-24pzs	STELS		101
JOGO DE FERRAMENTAS/29pçs	TOOL SET 29PCS JUEGO DE HERRAMIENTAS 29PZS	STELS		103
Jogo de Ferramentas/39pçs	Tool Set-39pcs Juego de Herramientas-39pzs	STELS		101
JOGO DE FERRAMENTAS/41pçs	TOOL SET 41PCS JUEGO DE HERRAMIENTAS 41PZS	STELS		102
JOGO DE FERRAMENTAS/57pçs	TOOL SET 57PCS JUEGO DE HERRAMIENTAS 57PZS	STELS		103
JOGO DE FERRAMENTAS/94pçs	TOOL SET 94PCS JUEGO DE HERRAMIENTAS 94PZS	STELS		102
Jogo de Formões	Chisels set Juego de Formones	MTX		72
Jogo de formões para entalhador	Chisels set Juego de cinceles	SPARTA		72
Jogo de fresa para madeira	Wood cutter set Juego de fresa para madera	SPARTA		156
Jogo de Lima rotativa	Rotating File Set Juego de Lima rotativa	MTX		156
Jogo de Limas Bastardas 3 pçs	Set of files Juego de rascador	MTX	2019	44
Jogo de Limas Bastardas 5 pçs	Set of files Juego de rascador	MTX	2019	44
Jogo de Pontas montadas	Set of mounted tips Juego de puntas montadas	MTX		182
Jogo de serra copo para cerâmica e telha	"Ceramic and tile glass saw set Juego de Sierra de agujero para cerámica y teja"	MTX		168
Jogo de Soquetes	Socket Set Juego de Enchufe	GROSS		94
Jogo de Soquetes	Socket Set Juego de Sockets	MTX		98
Jogo de Soquetes - 20pçs - 3/4"	Socket Set - 20pcs - 3/4" Juego de Sockets - 20pzs - 3/4"	MTX		100
Jogo de Soquetes - 26pçs - 3/4"	Socket Set - 26pcs - 3/4" Juego de Sockets - 26pzs - 3/4"	MTX		100
Jogo de Soquetes Multifuncional	Socket Set Multifuncional Juego de Enchufe multifuncional	GROSS		95
Jogo de Soquetes sextavados - 10 peças	Socket Set Hexagonal - 10 parts Juego de Sockets hexagonales - 10 piezas	STELS		98
Jogo de Soquetes sextavados - 11 peças	Socket Set Hexagonal - 11 parts Juego de Sockets hexagonales - 11 piezas	STELS		98
Jogo de Soquetes SPLINE	Socket Set SPLINE Juego de Sockets SPLINE	MTX		104
Jogo de Soquetes SPLINE	Socket Set SPLINE Juego de Sockets SPLINE	STELS		105
Jogo de Soquetes/curto	Socket Set /short Juego de Sockets /corto	MTX		104
Jogo de Soquetes/curto	Socket Set /short Juego de Sockets /corto	MTX		104
Jogo de Soquetes/curto	Socket Set /short Juego de Sockets /corto	STELS		105
Jogo de Soquetes/curto	Socket Set /short Juego de Sockets /corto	STELS		105
Jogo de Soquetes/longo	Sockets / Long Set Juego de Sockets / Largo	MTX		104
Jogo de Soquetes/longo	Sockets / Long Set Juego de Sockets / Largo	STELS		105
Jogo de tarraxas para canos metálicos	Set of metal pipe fittings Juego de taras para tuberías metálicas	SPARTA		185
Jogo de tarraxas para canos metálicos	Set of metal pipe fittings Juego de taras para tuberías metálicas	SPARTA		185
Jogo para serra tico tico	Tico-tico saw set Juego para sierra Tico-tico	MTX		191
Jogo para serra tico tico	Tico-tico saw set Juego para sierra Tico-tico	MTX		192
Jogo para serra tico tico	Tico-tico saw set Juego para sierra Tico-tico	MTX		193
Jogo serra copo para madeira	Hole saw set for wood Juego Sierra de agujero para madera	SPARTA		157
Jogo serra copo para madeira	Hole saw set for wood Juego Sierra de agujero para madera	MTX		157
Jogo serra copo para madeira	Hole saw set for wood Juego Sierra de agujero para madera	MTX		157
Jogo serra copo para madeira	Hole saw set for wood Juego Sierra de agujero para madera	MTX		157
"Jogos de Chaves Allen de 9 peças ponta abaulada "	"Allen Key 9-Piece Round edge Juegos de Chaves Allen de 9 piezas Punta redonda"	MTX		17
Jogos de Chaves Allen / Torx Argola	Allen / Torx key set Ring Juegos de Llaves Allen / Torx Anillo	SPARTA		19
Jogos de Chaves Torx de 9 peças	Torx key set - 9 peices Juegos de Chaves Torx de 9 piezas	MTX		16
Junta universal	Universal joint Junta universal	MTX		108

K



PRODUTOS	TRADUÇÃO	MARCA	LANÇA MENTOS	PAG.
Kit Churrasco	Barbecue kit Kit Barbacoa	PALISAD		152
Kit de reparo para pulverizadores	Spray Repair Kit Kit de reparación para pulverizadores	PALISAD	2019	150
Kit reparo para pistola de pintura	Repair kit for paint spray gun Kit de reparación para pistola de pintura	STELS		127

L



PRODUTOS	TRADUÇÃO	MARCA	LANÇA MENTOS	PAG.
Lâmina para estilete	Stiletto blade Láminas para estilete	GROSS		186
Lâmina para serrote de arco	Bow hacksaw blade Lámina para serrucho de arco	PALISAD		130
Lâminas para estiletos	Stitching blades Láminas para estiletos	SPARTA		188
Lâminas para estiletos	Stitching blades Láminas para estiletos	MTX		189
Lâminas para estiletos trapezoidais	Vane blades for trapezoidal style Láminas para estiletos trapezoidales	MTX		189
Lâminas para serra tico tico - Jogo	Saw Blades for Tactical Saw - Game Láminas para sierra tico tico - Juego	MTX		190
Lâminas para serra tico tico - Jogo	Saw Blades for Tactical Saw - Game Láminas para sierra tico tico - Juego	MTX		190
Lâminas Serras	Saw blades Láminas Sierras	SPARTA		190
Lâminas Serras	Saw blades Láminas Sierras	MTX		190
Lápis de marceneiro	Woodworking pencils Lápis de carpintería	SPARTA		201
Ligação para 2 saídas ajustáveis	Connection for 2 adjustable outputs Conexión para 2 salidas ajustables	PALISAD		147
Lima Formato Chata - Murça	Flat Scraper Raspador plano	MTX	2019	43
Lima Formato Meia Cana - Bastarda	Half Cane Scraper Rascador Formato Medias Cana	MTX	2019	42
Lima Formato Meia Cana - Murça	Half Cane Scraper Rascador Formato Medias Cana	MTX		41
Lima Formato Meia Cana - Murça	Half Cane Scraper Rascador Formato Medias Cana	MTX	2019	44
Lima Formato Plano - Bastarda	Flat Scraper Raspador plano	MTX	2019	42
Lima Formato Plano - Murça	Flat Scraper Raspador plano	MTX		41
Lima Formato Quadrada - Murça	Square Format Rascador Formato Cuadrado	MTX	2019	43
Lima Formato Redondo - Bastarda	Round Scraper Rascador Formato Redondo	MTX	2019	42
Lima Formato Redondo - Murça	Round Scraper Rascador Formato Redondo	MTX		41
Lima Formato Redondo - Murça	Round Scraper Rascador Formato Redondo	MTX	2019	43
Lima Formato Triangular - Bastarda	Triangular shape scraper Rascador Formato Triangular	MTX	2019	42
Lima Formato Triangular - Murça	Triangular shape scraper Rascador Formato Triangular	MTX		41
Lima Formato Triangular - Murça	Triangular shape scraper Rascador Formato Triangular	MTX	2019	43
"Linha de Bits Industrial TORX Cromo Molibdênio 5 Peças"	"Industrial Bit Series Chrome Molybdenum 5 Pieces Línea de Bits Industrial Cromo Molibdeno 5 Piezas"	MTX		23
Linha de Bits Ponteira Fenda 5 Peças	Fenda Point Bits Line 5 Pieces Línea de Bits Puntera Fenda 5 Piezas	MTX		23
Linha de Bits Ponteira Phillips 5 Peças	Phillips Point Bits Line 5 Pieces Línea de Bits Puntera Phillips 5 Piezas	MTX		22
Linha de soquetes industriais	Industrial Socket Line Línea de sockets industriales	STELS		97
Lixa	Sandpaper Papel de lija	MTX		183
Lixa	Sandpaper Papel de lija	MTX	2019	183
Lixa	Sandpaper Papel de lija	MTX	2019	183
Luvas para Jardim	Garden gloves Guantes de jardín	PALISAD		150
Luvas para jardim	Garden gloves Guantes de jardín	PALISAD		150

M



PRODUTOS	TRADUÇÃO	MARCA	LANÇA MENTOS	PAG.
Macaco Hidráulico tipo garrafa	Bottle type hydraulic jack Gato hidráulico tipo botella	SPARTA		122
Macaco Hidráulico tipo jacaré	Alligator Type Hydraulic Jack Gato hidráulico tipo jacaré	SPARTA		121
Macaco Hidráulico tipo jacaré	Alligator Type Hydraulic Jack Gato hidráulico tipo jacaré	SPARTA		121
Macaco Hidráulico tipo jacaré	Alligator Type Hydraulic Jack Gato hidráulico tipo jacaré	STELS		121
Macaco Hidráulico tipo jacaré	Alligator Type Hydraulic Jack Gato hidráulico tipo jacaré	MTX		121
Maçarico	Blowtorch Soplete	MTX		214



PRODUTOS	TRADUÇÃO	MARCA	LANÇAMENTOS	PAG.
Maçarico	Blowtorch Soplete	MTX		214
Maçarico	Blowtorch Soplete	MTX		214
Machado cabo de fibra	Ax fiber cable Machado cable de fibra	SPARTA		68
Macho	Male Masculino	MTX		184
"Maleta Conjunto de Bits/Ponteiras e Brocas 40pcs "	"Bits / Tips and Drills Set 40pcs Maleta Conjunto de Bits / Puntas y Brocas 40pcs "	MTX		28
Maleta Conjunto de bits e cabeças 26 pcs	Case Set of bits and heads 26 pcs Maleta Conjunto de bits y cabezas 26 pcs	GROSS		27
Maleta Conjunto de bits e cabeças 33 pcs	Case Set of bits and heads 33 pcs Maleta Conjunto de bits y cabezas 33 pcs	GROSS		27
Maleta Conjunto de bits e cabeças 61pcs	Case Set of bits and heads 61 pcs Maleta Conjunto de bits y cabezas 61pcs	MTX		27
Mandril Aperto Rápido	Fast Clamp Chuck Mandril Apriete Rápido	MTX		45
Mandril Auto Lock	Auto Lock Chuck Mandril Auto Lock	MTX		45
Mandril de Chave Manual	Manual Switch Chuck Mandril de llave manual	MTX		45
Mangueira espiral de ar	Spiral air hose Manguera espiral de aire	STELS		124
Marreta oitavada	Octave hammer Mazza octava	SPARTA		12
Marreta oitavada cabo em fibra	Octave hammer with fiber cable Marreta octava con mango de fibra	MTX		12
Marreta Quadrada	Square Mallet Mazza cuadrado	SPARTA		12
Marreta Quadrada cabo longo	Mallet Square Long Cable Mazza cuadrado de mango largo	MTX		13
Martelo bola cabo de fibra emborrachado	Ball hammer with rubber cable Martillo bola con mango de goma	MTX		10
Martelo bola cabo de madeira polida	"Ball hammer with polished wood handle Martillo bola con mango de madera pulida"	SPARTA		10
Martelo de borracha cabo de madeira	Rubber hammer with wooden handle Martillo de goma con mango de madera	SPARTA		13
Martelo de borracha para Cerâmica	Ceramic Rubber Hammer Martillo de goma Cerámica	MTX		14
Martelo de borracha para Porcelanato	Rubber Hammer Porcelain Martillo de goma Porcelanato	MTX		14
Martelo de borracha Preto e Branco	Black and White Rubber Hammer Martillo de goma Blanco y negro	MTX		14
Martelo pena cabo de madeira	Machinist's hammer wooden handle Martillo de pena con mango de madera	SPARTA		10
Martelo pena cabo de madeira pintado	"Machinist's hammer painted wood cable Martillo de pena mango de madera pintada"	MTX		10
Martelo Poliuretano anti-retorno	Anti-return polyurethane hammer Martillo Poliuretano anti-retorno	MTX		13
Martelo unha	Claw Hammer Martelo unha	MTX		12
Martelo unha Cabeça Imantada	Claw Hammer Head Magnet Martelo unha Cabeça imã	MTX		11
Martelo unha Cabo de fibra	Claw hammer Fiber cable Martillo unha mango de fibra	MTX		11
Martelo unha cabo de madeira	Claw hammer wooden handle Martillo unha mango de madera	SPARTA		11
Martelo Unha Tubular com cabo emborrachado	"Tubular Nail Hammer with Rubberized Cable Martillo Uña Tubular con Mango de goma"	SPARTA		11
Medidor de distância a laser	Laser Distance Meter Medidor de distancia láser	GROSS		82
"Mesas dobráveis de alumínio com tampo de MDF "	"Aluminum folding tables with MDF tops Mesas plegables de aluminio con tableros de MDF"	PALISAD		150
Micrômetro	Micrometer Micrómetro	MTX		76
Mini - Pá de bico	Mini Shovel Mini - Pala de pico	PALISAD		141
"Mini Alicate Bico Meia-Cana Curvo Longo (150mm)"	"Mini Pliers Long Beak Medium Curved Mini Pinza Punta Media-Canã Curvo Largo"	GROSS	2019	47
Mini Alicate Bico Meia-Cana Curvo	Mini Pliers Beak Half-Cane Curved Mini Pinza Punta Media-Canã Curvo	MTX		53
Mini Alicate Bico Meia-Cana Curvo (125mm)	Pliers Beak Half-Cane Curved Mini Pinza Punta Media-Canã Curvo Mini	GROSS	2019	46
Mini Alicate Bico Meia-Cana Reto	Mini Pliers Beak Half-Cane Straight Mini Pinza Punta Media-Canã Reto	MTX		53
Mini Alicate Bico Meia-Cana Reto (125mm)	Pliers Beak Half-Cane Straight Mini Pinza Punta Media-Canã Reto Mini	GROSS	2019	46
Mini Alicate Bico Meia-Cana Reto (127mm)	Pliers Beak Half-Cane Straight Mini Pinza Punta Media-Canã Reto Mini	GROSS	2019	47
Mini Alicate Bico Redondo (127mm)	Mini Round Bead Pliers Mini Pinza Punta Redonda	GROSS	2019	47
Mini Alicate Corte Diagonal	Mini Diagonal Cutting Pliers Mini Pinza Corte Diagonal	MTX		53
Mini Alicate Corte Diagonal (110mm)	Diagonal Cutting Pliers Mini Pinza Corte Diagonal Mini	GROSS	2019	46
Mini Alicate Corte Frontal (105mm)	Mini Front Cutting Pliers Mini Pinza Corte Frontal	GROSS	2019	47
Mini Alicate Universal	Mini Universal pliers Mini Alicate Universal	MTX		53
Mini Alicate Universal (120mm)	Universal pliers Mini Alicate Universal Mini	GROSS	2019	46
Mini arco de serra	Mini sawing bow Mini arco de sierra	MTX		195

PRODUTOS	TRADUÇÃO	MARCA	LANÇA MENTOS	PAG.
Mini cortador de tubos	Mini tube cutter Mini cortador de tubos	MTX		196
Mini torno/morsa 70mm base articulada	Mini lathe / vise 70mm hinged base Mini torno / morsa 70mm base articulada	SPARTA		63
Mini torno/morsa articulado com ventosa	"Mini articulated vice / vise with suction cup Mini torno / morsa articulado con ventosa"	SPARTA		62
Misturador de massa com haste sextavada	Mass Mixer Mezclador de masa	MTX		202
Misturador de tinta	Ink Mixer Mezclador de tinta	MTX		202
Misturador de tinta com encaixe SDS Plus	Mass Mixer Mezclador de masa	MTX		202
Multiteste Digital LCD	Multitest Digital LCD Multifunción Digital LCD	SPARTA		36
Multiteste Digital LCD led	Multitest Digital LCD led Multifunción Digital LCD led	SPARTA		36

N



PRODUTOS	TRADUÇÃO	MARCA	LANÇA MENTOS	PAG.
Nível 2 bolhas	Level 2 bubbles Nivel 2 burbujas	SPARTA		79
NÍVEL A LASER 5 LINHAS	5 LEVEL LASER LEVEL NIVEL A LASER 5 LÍNEAS	MTX		84
Nível a laser com tripé	Laser Level with Tripod Nivel láser con tripode	MTX		81
Nível a laser com tripé	Laser Level with Tripod Nivel láser con tripode	MTX		81
Nível a Laser de alta precisão com tripé	"High Precision Laser Level with Tripod Nivel láser de alta precisión con tripode"	MTX		83
Nível a laser esquadro	Level laser square Nivel láser escuadra	MTX		80
Nível a laser esquadro	Level laser square Nivel láser escuadra	MTX		80
Nível de Alumínio	Level of Aluminum Nivel de aluminio	MTX		78
Nível de Alumínio	Level of Aluminum Nivel de aluminio	MTX		78
Nível de Alumínio 3 Bolhas	Level of Aluminum 3 Bubbles Nivel de aluminio 3 burbujas	MTX		78
Nível de alumínio imantando	Level of aluminum magnetizing Nivel de aluminio imantando	MTX		79
Nível de canto	Level of corner Nivel de esquina	SPARTA		82
Nível Plástico imantado	Plastic Level magnetized Nivel Plástico imantado	SPARTA		79
Nível Trapezoidal	Trapezoidal Level Nivel Trapezoidal	MTX		79

P



PRODUTOS	TRADUÇÃO	MARCA	LANÇA MENTOS	PAG.
Paquímetro Digital	Digital Caliper Calibrador Digital	MTX		76
Paquímetro Universal	Universal Caliper Calibrador Universal	MTX		76
Pazinha	Little Shovel Pequeña pala	PALISAD		138
Pazinha	Little Shovel Pequeña pala	PALISAD		139
Pazinha	Little Shovel Pequeña pala	PALISAD		136
Pazinha estreita	Little paw Pala estrecha	PALISAD		136
Pé de cabra	Wrecking Bar Barreta Sacaclavos	SPARTA		72
Pé de cabra	Wrecking Bar Barreta Sacaclavos	MTX		72
Pedras de afiar	Sharpening stones Piedras de afilado	MTX		182
Pedras de afiar	Sharpening stones Piedras de afilado	MTX		182
Pinador Pneumático / 10-50mm	Pneumatic Pincher/10-50mm Pintor Neumático/10-50mm	MTX		92
Pinos	Pines Pinos	MTX		91
Pinos / Pregos	Pines / Nails Pinos / Clavos	MTX		90
Pistola de jateamento de areia	Sand blasting gun Pistola de chorro de arena	STELS		127
Pistola de limpeza	Cleaning gun Pistola de limpieza	STELS		126
Pistola de pintura	Spray gun Pistola de pintura	STELS		128
Pistola de pintura	Spray gun Pistola de pintura	STELS		128
Plaina Profissional	Professional Plaine Cepilladora profesional	SPARTA		68
Plainas Hobbie	Hobbie Planers Llanas Hobbie	SPARTA		68
Pó de giz	Chalk powder Polvo de tiza	MTX		201
Ponteiro	Pointer Puntero	MTX		159



PRODUTOS	TRADUÇÃO	MARCA	LANÇA MENTOS	PAG.
Ponteiro	Pointer Puntero	MTX		159
Ponteiro Redondo	Round Pointer Puntero Redondo	SPARTA	2019	61
Ponteiro Sextavada com protetor	Hexagonal Pointer with Protector Puntero Sextava con protector	SPARTA		61
Porta Cossinetes	Door Cossinetes Puerta Cossinetes	MTX		184
Porta eletrodo	Electrode holder Puerta electrodo	MTX		215
Porta ferramentas	Toolholder Puerta de herramientas	MTX		212
Prumo / Nível a Laser com tripé	Plumb / Laser Level with Tripod Prumo / Nivel a láser con trípode	MTX		81
Prumo de aço	Steel plumbing Prumo de acero	MTX		205
Prumo e nível a laser	Plummet and laser level Prumo y nivel láser	MTX		80
Pulseira Magnética	Magnetic Bracelet Pulsera magnética	MTX		29
Pulverizadores agrícolas	Agricultural Sprayers Pulverizadores agrícolas	PALISAD		149

R



PRODUTOS	TRADUÇÃO	MARCA	LANÇA MENTOS	PAG.
Raspadores de rejunte	Grout Scrapers Rascadores de rejunte	MTX		198
Raspadores de rejunte	Grout Scrapers Rascadores de rejunte	MTX		198
Rebitador Manual Profissional	Professional Manual Riveter Rebajador Manual Profesional	GROSS		86
Rebitador Manual Tipo Alavanca	Manual Riveter Type Lever Rebajador Manual Tipo Palanca	MTX		87
Rebitador Manual Tipo Alavanca	Manual Riveter Type Lever Rebajador Manual Tipo Palanca	SPARTA		87
Rebitador Manual Tipo Alicate	Manual Riveter Pliers Type Rebajador Manual Tipo Alicate	MTX		87
Rebitador Tipo Alicate	Riveter Pliers Type Rebajador Tipo Alicate	MTX		86
Rebites de repuxo	Flake rivets Rejillas de repuesto	MTX		91
Rebolos diamantados	Diamond wheels Rebolos diamantados	MTX		169
Removedor para anéis de pressão com bicos	"Pressure Ring Remover with Nozzles Eliminador para anillos de presión con boquillas"	SPARTA		50
Rodas de lixa	Sandpaper wheels Ruedas de lija	MTX		175
Rodel para cortador de pisos	Rodel for floor cutter Rodillo para cortador de pisos	MTX		207
Rodízio de GEL giratório com freio	Rotary GEL caster with brake Rueda de GEL giratoria con freno	PALISAD	2019	211
Rodízio de GEL giratório sem freio	Rotary GEL caster without brake Rueda de GEL giratoria sin freno	PALISAD	2019	211
Rodízio fixo de pvc e poliuretano com freio	"Fixed pvc and polyurethane brake caster with brake Rodamiento fijo de pvc y poliuretano con freno"	PALISAD	2019	211
Rodízio Fixo sem freio	Fixed caster without brake Rodamiento fijo sin freno	PALISAD	2019	210
Rodízio Fixo sem freio	Fixed caster without brake Rodamiento fijo sin freno	PALISAD	2019	211
Rodízio giratório com freio	Rotary caster with brake Rueda giratoria con freno	PALISAD	2019	210
Rodízio PVC fixo sem freio	Fixed PVC caster without brake Rodamiento de PVC fijo sin freno	PALISAD	2019	210
Rodízio PVC giratório sem freio	Rotary PVC caster with brake Rueda PVC giratoria con freno	PALISAD	2019	210
Rodo multiuso	Multipurpose wheel Rodo multiuso	STELS		123
Rolo para pintura de canto	Roll for corner painting Rodillo para pintura de esquina	MTX		200

S



PRODUTOS	TRADUÇÃO	MARCA	LANÇA MENTOS	PAG.
Saca polias	Remove pulleys Saca poleas	SPARTA		122
Sacho combinado duas pontas	Hoe combined two ends Azada combinado duas extremidades	PALISAD		137
Sacho combinado duas pontas	Hoe combined two ends Azada combinado duas extremidades	PALISAD		137
Sacho combinado duas pontas	Hoe combined two ends Azada combinado duas extremidades	PALISAD		138
Sacho combinado duas pontas	Hoe combined two ends Azada combinado duas extremidades	PALISAD		140
Serra copo - Widea	Cup saw - Widea Sierra de agujero - Widea	MTX		158
Serra copo aço rápido	Quick steel cup saw Sierra de agujero de acero rápido	MTX		166
Serra copo para cerâmica e telha	Ceramic cup saw and tile Sierra de agujero para cerámica y teja	MTX		168
Serra copo para vidro	Cup saw for glass Sierra de agujero para vidrio	MTX		167
Serra copo para vidro e cerâmica	Cup Saw for glass and ceramics Sierra de agujero para vidrio y cerámica	SPARTA		167

PRODUTOS	TRADUÇÃO	MARCA	LANÇA MENTOS	PAG.
Serra meia esquadria manual de precisão	Precision half-miter saw Sierra media escuadra manual de precisión	MTX		69
Serra meia esquadria manual de precisão	Precision half-miter saw Sierra media escuadra manual de precisión	MTX		69
Serrote com cabo de madeira	Hacksaw with wooden handle Sierra con cable de madera	SPARTA		71
Serrote de costa para madeira 12 TPI	Wood sawing saw 12 TPI Serrucho de costa para madera 12 TPI	MTX		70
Serrote de poda	Pruning saw Serrucho de poda	PALISAD	2019	130
Serrote para galhos 350 mm / 14"	Slicer for branches Serrucho para ramas	PALISAD		131
Serrote para gesso/Drywall	Plaster saw/drywall Serrucho para yeso / Drywall	MTX		70
Serrote para gesso/drywall cabo de madeira	"Plaster saw/drywall wooden cable Serrucho para yeso / Drywall mango de madera"	SPARTA		71
Serrote para madeira	Miter Saw Blade Lámina para sierra media escuadra	MTX		70
Soquete para vela estriado	Socket for candle Enchufe para la vela	GROSS		94
Soquetes Estriado	Striated Sockets Enchufe Estriado	STELS		94
Soquetes Estriado 1/2"	Socket Stretch 1/2 " Enchufes Estriado 1/2 "	STELS		96
Soquetes Longo Sextavado	Long Sockets Sixth Enchufes Largo hexagonal	STELS		96
Soquetes Magneticos	Magnetic Sockets Soportes Magneticos	MTX		29
Soquetes Sextavado 1/2"	Sixth Sockets 1/2" Enchufes Sextavado 1/2"	MTX		99
Soquetes Sextavados Temperados	Tempered Hexagonal Sockets Enchufes Sexto Templado	STELS		95
Suporte / haste de fixação para serra copo	"Clamping bracket / stem for cup saw Soporte / vástago de fijación para Sierra de agujero"	MTX		166
Suporte de boina	Beret holder Soporte de boina	MTX		174
Suporte para furadeira	Drill stand Soporte para taladro	SPARTA		215
Suporte para serra copo	Cup saw holder Soporte para Sierra de agujero	MTX		168

T



PRODUTOS	TRADUÇÃO	MARCA	LANÇA MENTOS	PAG.
Taco lixador	Sanding pad Taco lijador	SPARTA		183
Talhadeira	Chisel Cincel	MTX		159
Talhadeira	Chisel Cincel	MTX		159
Talhadeira Ponta Chata	Tip Flat Stone Chisel Cincel Punta Plana	SPARTA	2019	61
Talhadeira Plana	Flat Stone Chisel Cincel Plano	SPARTA	2019	61
Talhadeira Sextavada com protetor	Hexagonal Cleaver with protector Taladradora Sexta con protector	SPARTA		61
Tesoura corta vergalhões	Scissors cuts rebar Tijera corta barras	MTX		196
Tesoura direita para chapas	Right Scissor for Sheets Tijera derecha para chapas	MTX		194
Tesoura esquerda para chapas	Left-handed scissors for plates Tijera izquierda para chapas	MTX		194
Tesoura para chapas	Shears for plates Tijeras para chapas	SPARTA		194
Tesoura para cortar galhos secos e duros	"Scissors for cutting hard and dry twigs Tijeras para cortar ramas secas y duras"	PALISAD		131
Tesoura para galhos até 25mm	Scissor for branches up to 25mm Tijeras para ramas hasta 25mm	PALISAD		132
Tesoura para Grama 310mm	Scissors for Grass 310mm Tijeras para Hierba 310mm	PALISAD		134
Tesoura para Grama 330mm	Scissors for Grass 330mm Tijeras para Hierba 330mm	PALISAD		134
Tesoura para Grama 520mm	Scissors for Grass 520mm Tijeras para Hierba 520mm	PALISAD		134
Tesoura para Grama 560mm	Scissors for Grass 560mm Tijeras para Hierba 560mm	PALISAD		134
Tesoura para Jardim	Garden Scissors Tijera para Jardín	PALISAD		131
Tesoura para Jardim	Garden Scissors Tijera para Jardín	PALISAD		132
Tesoura para Jardim	Garden Scissors Tijera para Jardín	PALISAD		132
Tesoura reta para chapas	Straight sheet shears Tijeras rectas para chapas	MTX		194
Tesouras corta galhos até Ø25mm	Scissors cuts branches up to Ø25mm Tijeras corta ramas hasta Ø25mm	PALISAD		133
Tesouras corta galhos até Ø30mm	Scissors cuts branches up to Ø30mm Tijeras corta ramas hasta Ø30mm	PALISAD		133
Tesouras corta galhos até Ø35mm	Scissors cuts branches up to Ø35mm Tijeras corta ramas hasta Ø35mm	PALISAD		133
Tesouras corta galhos Ø25mm	Scissors cuts branches up to Ø25mm Tijeras corta ramas hasta Ø25mm	PALISAD		133
Tornos / Morsas Base Giratória	Vices turntables Prensatornillos base rotativos	MTX		64



PRODUTOS	TRADUÇÃO	MARCA	LANÇA MENTOS	PAG.
Tornos / Morsas de Bancada	Bench Vices Prensatornillos	MTX		64
Torquês Armador	Concretor's Pincers Tenaza para armar	SPARTA		55
Torquês Azulejista	Tile Pincers Tenaza para azulejo	SPARTA		55
Torquímetro	Torquemeter Llave dinamométrica	MTX		111
Torquímetro eletrônico	Electronic torque wrench Torquímetro electrónico	GROSS		111
Trava Cabo de Aço	Locks Steel Cable Bloqueos Cable de Acero	MTX	2019	216
Trava Cabo de Aço	Locks Steel Cable Bloqueos Cable de Acero	MTX	2019	216
Trava Cabo de Aço	Locks Steel Cable Bloqueos Cable de Acero	MTX	2019	216
Trena	Trains Cinta Métrica	SPARTA		74
Trena	Trains Cinta Métrica	MTX		74
Trena	Trains Cinta Métrica	GROSS		75
Trena Longa	Long Trains Cinta Métrica Larga	SPARTA		75
Tripé	Tripod Trípode	MTX		83

V



PRODUTOS	TRADUÇÃO	MARCA	LANÇA MENTOS	PAG.
Válvula pulverizadora	Spray Valve Válvula pulverizadora	PALISAD		144
Vassoura para grama e jardim	Grass and garden broom Escoba para césped y jardín	PALISAD		140
Vassoura para grama e jardim 22 dentes	Grass and garden broom Escoba para césped y jardín	PALISAD		138
Ventosa Plástica	Plastic Suction Cup Ventosa Plástica	MTX		206
Ventosas de Alumínio (Uso Profissional)	"Aluminum Suction Cups (Professional Use) Ventosas de Aluminio (Uso Profesional)"	MTX		206
Vira macho	Male Tool Macho Herramienta	MTX		184
Vira macho	Male Tool Macho Herramienta	MTX		184



Conversão de polegada em milímetro (0 a 12")

1" = 25,40 mm

1 mm = 0,03937"

Polegada	0	1	2	3	4	5	6	7	8	9	10	11	12	Polegada
0	mm	25.400	50.800	76.200	101.600	127.000	152.400	177.800	203.200	228.600	254.000	279.400	304.800	0
1/64	0.397	25.797	51.197	76.597	101.997	127.397	152.797	178.197	203.597	228.997	254.397	279.797	305.197	1/64
1/32	0.794	26.194	51.594	76.994	102.394	127.794	153.194	178.594	203.994	229.394	254.794	280.194	305.594	1/32
3/64	1.191	26.591	51.991	77.391	102.791	128.191	153.591	178.991	204.391	229.791	255.191	280.591	305.991	3/64
1/16	1.588	26.988	52.388	77.788	103.188	128.588	153.988	179.388	204.788	230.188	255.588	280.988	306.388	1/16
5/64	1.984	27.385	52.784	78.185	103.585	128.985	154.385	179.785	205.185	230.585	255.985	281.385	306.785	5/64
3/32	2.381	27.781	53.181	78.581	103.981	129.382	154.782	180.182	205.582	230.982	256.382	281.782	307.182	3/32
7/64	2.778	28.178	53.578	78.978	104.378	129.778	155.178	180.578	205.979	231.379	256.779	282.179	307.579	7/64
1/8	3.175	28.575	53.975	79.375	104.775	130.175	155.575	180.975	206.375	231.775	257.176	282.576	307.976	1/8
9/64	3.572	28.972	54.372	79.772	105.172	130.572	155.972	181.372	206.772	232.172	257.572	282.972	308.372	9/64
5/32	3.969	29.369	54.769	80.169	105.569	130.969	156.369	181.769	207.169	232.569	257.969	283.369	308.769	5/32
11/64	4.366	29.766	55.166	80.566	105.966	131.366	156.766	182.166	207.566	232.966	258.366	283.766	309.166	11/64
3/16	4.763	30.163	55.563	80.963	106.363	131.763	157.163	182.563	207.963	233.363	258.763	284.163	309.563	3/16
13/64	5.159	30.559	55.959	81.360	106.760	132.160	157.560	182.960	208.360	233.760	259.160	284.560	309.960	13/64
7/32	5.556	30.956	56.356	81.756	107.156	132.557	157.957	183.357	208.757	234.157	259.557	284.957	310.357	7/32
15/64	5.953	31.353	56.753	82.153	107.553	132.953	158.353	183.753	209.154	234.554	259.954	285.354	310.754	15/64
1/4	6.350	31.750	57.150	82.550	107.950	133.350	158.750	184.150	209.550	234.950	260.350	285.751	311.151	1/4
17/64	6.747	32.147	57.547	82.947	108.347	133.747	159.147	184.547	209.947	235.347	260.747	286.147	311.547	17/64
9/32	7.144	32.544	57.944	83.344	108.744	134.144	159.544	184.944	210.344	235.744	261.144	286.544	311.944	9/32
19/64	7.541	32.941	58.341	83.741	109.141	134.541	159.941	185.341	210.741	236.141	261.541	286.941	312.341	19/64
5/16	7.938	33.338	58.738	84.138	109.538	134.938	160.338	185.738	211.138	236.538	261.938	287.338	312.738	5/16
21/64	8.334	33.734	59.134	84.535	109.935	135.335	160.735	186.135	211.535	236.935	262.335	287.735	313.135	21/64
11/32	8.731	34.131	59.531	84.931	110.331	135.732	161.132	186.532	211.932	237.332	262.732	288.132	313.532	11/32
23/64	9.128	34.528	59.928	85.328	110.728	136.128	161.528	186.928	212.329	237.729	263.129	288.529	313.929	23/64
3/8	9.525	34.925	60.325	85.725	111.125	136.525	161.925	187.325	212.725	238.125	263.526	288.926	314.326	3/8
25/64	9.922	35.322	60.722	86.122	111.522	136.922	162.322	187.722	213.122	238.522	263.922	289.322	314.722	25/64
13/32	10.319	35.719	61.119	86.519	111.919	137.319	162.719	188.119	213.519	238.919	264.319	289.719	315.119	13/32
27/64	10.716	36.116	61.516	86.916	112.316	137.716	163.116	188.516	213.916	239.316	264.716	290.116	315.516	27/64
7/16	11.113	36.513	61.913	87.313	112.713	138.113	163.513	188.913	214.313	239.713	265.113	290.513	315.913	7/16
29/64	11.509	36.909	62.309	87.710	113.110	138.510	163.910	189.310	214.710	240.110	265.510	290.910	316.310	29/64
15/32	11.906	37.306	62.706	88.106	113.506	138.907	164.307	189.707	215.107	240.507	265.907	291.307	316.707	15/32
31/64	12.303	37.703	63.103	88.503	113.903	139.303	164.703	190.103	215.504	240.904	266.304	291.704	317.104	31/64
1/2	12.700	38.100	63.500	88.900	114.300	139.700	165.100	190.500	215.900	241.300	266.701	292.101	317.501	1/2
33/64	13.097	38.497	63.897	89.287	114.697	140.097	165.497	190.897	216.297	241.697	267.097	292.497	317.898	33/64
17/32	13.494	38.894	64.294	89.684	115.094	140.494	165.894	191.294	216.694	242.094	267.494	292.894	318.294	17/32
35/64	13.891	39.291	64.691	90.081	115.491	140.891	166.291	191.691	217.091	242.491	267.891	293.291	318.691	35/64
9/16	14.288	39.688	65.088	90.488	115.888	141.288	166.688	192.088	217.488	242.888	268.288	293.688	319.088	9/16
37/64	14.684	40.084	65.485	90.885	116.285	141.685	167.085	192.485	217.885	243.285	268.685	294.085	319.485	37/64
19/32	15.081	40.481	65.881	91.281	116.681	142.082	167.482	192.882	218.282	243.682	269.082	294.482	319.882	19/32
39/64	15.478	40.878	66.278	91.678	117.078	142.478	167.878	193.279	218.679	244.079	269.479	294.879	320.279	39/64
5/8	15.875	41.275	66.675	92.075	117.475	142.875	168.275	193.675	219.075	244.475	269.876	295.276	320.676	5/8
41/64	16.272	41.672	67.072	92.472	117.872	143.272	168.672	194.072	219.472	244.872	270.272	295.672	321.073	41/64
21/32	16.669	42.069	67.469	92.869	118.269	143.669	169.069	194.469	219.869	245.269	270.669	296.069	321.469	21/32
43/64	17.066	42.466	67.866	93.266	118.666	144.066	169.466	194.866	220.266	245.666	271.066	296.466	321.866	43/64
11/16	17.463	42.863	68.263	93.663	119.063	144.463	169.863	195.263	220.663	246.063	271.463	296.863	322.263	11/16
45/64	17.859	43.259	68.660	94.060	119.460	144.860	170.260	195.660	221.060	246.460	271.860	297.260	322.660	45/64
23/32	18.256	43.656	69.056	94.456	119.856	145.257	170.657	196.057	221.457	246.857	272.257	297.657	323.057	23/32
47/64	18.653	44.053	69.453	94.853	120.253	145.653	171.053	196.454	221.854	247.254	272.654	298.054	323.454	47/64
3/4	19.050	44.450	69.850	95.250	120.650	146.050	171.450	196.850	222.250	247.650	273.051	298.451	323.851	3/4
49/64	19.447	44.847	70.247	95.647	121.047	146.447	171.847	197.247	222.647	248.047	273.447	298.847	324.248	49/64
25/32	19.844	45.244	70.644	96.044	121.444	146.844	172.244	197.644	223.044	248.444	273.844	299.244	324.644	25/32
51/64	20.241	45.641	71.041	96.441	121.841	147.241	172.641	198.041	223.441	248.841	274.241	299.641	325.041	51/64
13/16	20.638	46.038	71.438	96.838	122.238	147.638	173.038	198.438	223.838	249.238	274.638	300.038	325.438	13/16
53/64	21.034	46.434	71.835	97.235	122.635	148.035	173.435	198.835	224.235	249.635	275.035	300.435	325.835	53/64
27/32	21.431	46.831	72.231	97.631	123.031	148.432	173.832	199.232	224.632	250.032	275.432	300.832	326.232	27/32
55/64	21.828	47.228	72.628	98.028	123.428	148.828	174.228	199.629	225.029	250.429	275.829	301.229	326.629	55/64
7/8	22.225	47.625	73.025	98.425	123.825	149.225	174.625	200.025	225.425	250.825	276.226	301.626	327.026	7/8
57/64	22.622	48.022	73.422	98.822	124.222	149.622	175.022	200.422	225.822	251.222	276.622	302.022	327.423	57/64
29/32	23.019	48.419	73.819	99.219	124.619	150.019	175.419	200.819	226.219	251.619	277.019	302.419	327.819	29/32
59/64	23.416	48.816	74.216	99.616	125.016	150.416	175.816	201.216	226.616	252.016	277.416	302.816	328.216	59/64
15/16	23.813	49.213	74.613	100.013	125.413	150.813	176.213	201.613	227.013	252.413	277.813	303.213	328.613	15/16
61/64	24.209	49.609	75.010	100.410	125.810	151.210	176.610	202.010	227.410	252.810	278.210	303.610	329.010	61/64
31/32	24.606	50.006	75.406	100.806	126.206	151.607	177.007	202.407	227.807	253.207	278.607	304.007	329.407	31/32
63/64	25.003	50.403	75.803	101.203	126.603	152.000	177.403	202.804	228.204	253.604	279.004	304.404	329.804	63/64

Conversão milímetro - polegada fração decimal

Fator de conversão: 1" = 25,4 mm

mm	0	1	2	3	4	5	6	7	8	9
0	0	0.03937"	0.07874"	0.11811"	0.15748"	0.19685"	0.23622"	0.27559"	0.31496"	0.35433"
10	0.39370"	0.43307"	0.47244"	0.51181"	0.55118"	0.59055"	0.62992"	0.66929"	0.70866"	0.74803"
20	0.78740"	0.82677"	0.86614"	0.90551"	0.94488"	0.98425"	1.02362"	1.06299"	1.10236"	1.14173"
30	1.18110"	1.22047"	1.25984"	1.29921"	1.33858"	1.37795"	1.41732"	1.45669"	1.49606"	1.53543"
40	1.57480"	1.61417"	1.65354"	1.69291"	1.73228"	1.77				

Tabelas de conversão de torques

Newton.metro (N.m) em kilograma-força.metro (kgf.m)

1 N.m = 0,10197 kgf.m

N.m	0	10	20	30	40	50	60	70	80	90
	(kgf.m)									
0	0	1.02	2.04	3.06	4.08	5.10	6.12	7.14	8.16	9.18
100	10.20	11.22	12.24	13.26	14.28	15.30	16.31	17.33	18.35	19.37
200	20.39	21.41	22.43	23.45	24.47	25.49	26.51	27.53	28.55	29.57
300	30.59	31.61	32.63	33.65	34.67	35.69	36.71	37.73	38.75	39.77
400	40.79	41.81	42.83	43.85	44.87	45.89	46.91	47.93	48.95	49.97
500	50.99	52.00	53.02	54.04	55.06	56.08	57.10	58.12	59.14	60.16
600	61.18	62.20	63.22	64.24	65.26	66.28	67.30	68.32	69.34	70.36
700	71.38	72.40	73.42	74.44	75.46	76.48	77.50	78.52	79.54	80.56
800	81.58	82.60	83.62	84.64	85.66	86.68	87.70	88.71	89.73	90.75
900	91.77	92.79	93.81	94.83	95.85	96.87	97.89	98.91	99.93	100.95
1000	101.97	102.99	104.01	105.03	106.05	107.07	108.09	109.11	110.13	111.15

Newton.metro (N.m) em libra-força.pé (lbf.pé)

1 N.m = 0,73756 lbf.pé

N.m	0	1	2	3	4	5	6	7	8	9
	(lbf.pé)									
0	0	0.74	1.48	2.21	2.95	3.69	4.43	5.17	5.90	6.64
10	7.38	8.12	8.86	9.59	10.33	11.07	11.81	12.54	13.28	14.02
20	14.76	15.50	16.2	16.97	17.71	18.45	19.19	19.93	20.65	21.40
30	22.14	22.88	23.62	24.35	25.10	25.83	26.57	27.31	28.04	28.78
40	29.52	30.26	31.00	31.73	32.47	33.21	33.95	34.69	35.42	36.16
50	36.90	37.64	38.38	39.11	39.85	40.59	41.33	42.07	42.80	43.54
60	44.28	45.02	45.76	46.49	47.23	47.97	48.71	49.45	50.18	50.92
70	51.66	52.40	53.14	53.87	54.61	55.35	56.09	56.83	57.56	58.30
80	59.04	59.78	60.52	61.25	62.00	62.73	63.47	64.21	64.94	65.68
90	66.42	67.16	67.90	68.63	69.37	70.11	70.85	71.59	72.32	73.06
100	73.80	74.54	75.28	76.01	76.75	77.49	78.23	78.97	79.70	80.44

libra-força.pé em Newton.metro

1 lbf.pé = 1,356 N.m

lbf.pé	0	1	2	3	4	5	6	7	8	9
	(N.m)									
0	0	1.36	2.71	4.07	5.42	6.78	8.14	9.49	10.85	12.20
10	13.56	14.92	16.27	17.63	18.98	20.34	21.70	23.05	24.41	25.76
20	27.12	28.48	29.83	31.19	32.54	33.90	35.26	36.61	37.97	39.32
30	40.68	42.04	43.39	44.75	46.10	47.46	48.82	50.17	51.53	52.88
40	54.24	55.60	56.95	58.31	59.66	61.02	62.38	63.73	65.09	66.44
50	67.80	69.16	70.51	71.87	73.22	74.58	75.94	77.29	78.65	80.00
60	81.36	82.72	84.07	85.43	86.78	88.14	89.50	90.85	92.21	93.56
70	94.92	96.28	97.63	98.99	100.34	101.70	103.06	104.41	105.77	107.12
80	108.48	109.84	111.19	112.55	113.90	115.26	116.62	117.97	119.33	120.68
90	122.04	123.40	124.75	126.11	127.46	128.82	130.18	131.53	132.89	134.24
100	135.60	136.96	138.31	139.67	141.02	142.38	143.74	145.09	146.45	147.80

1 Lbf. pé = 12 Lbf.pol

Fator de cálculo de torques

Unidade Conhecida	Unidade de Medição					
	= N.cm	= N.m	= kgf.cm	= kgf.m	= lbf.pol	= lbf.pé
N.cm	1	0.01	0.10197	0.00102	0.0885	0.00738
N.m	100	1	10.197	0.10197	8.851	0.7376
kgf.cm	9.807	0.09807	1	0.01	0.868	0.0723
kgf.m	980.7	9.807	100	1	86.796	7.233
lbf.pol	11.298	0.11298	1.152	0.01152	1	0.0833
lbf.pé	135.58	1.3558	13.825	0.13825	12	1

SIMBOLOGIA TÉCNICA

TECHNICAL SYMBOLS | SIMBOLOGÍA TÉCNICA

PRINCIPAL



CÓDIGO
CODE



CARACTERÍSTICAS
Technical Features



PESO CABEÇA
Head Weight
Peso Cabeça



PESO TOTAL
Total Weight



PESO TOTAL
Total Weight
Peso Total



CAIXA MASTER
Box Master | Caja Máster



QUANT. MINÍMA
Quant. Minimum
Cantidad Mínimo



DIÂMETRO
Diameter
Diámetro



PERFIL FENDA
Fenda profile | Perfil fenda



PERFIL PHILLIPS
Profile phillips | Perfil phillips



PERFIL POZIDRIVE
Profile pozidrive | Perfil pozidrive



PERFIL TORX - bit/ponta
Profile TORX - bit/tip
Perfil TORX - bit/punta



PERFIL TORX com guia
Profile TORX with guide
Perfil TORX con guía



PERFIL TORX soquete/encaixe
Profile TORX socket / fitting
Perfil TORX enchufe / encajar



PERFIL SEXTAVADO bit/ponta
Profile Six point bit/tip
Perfil sextavado bit/punta



PERFIL SEXTAVADO soquete/encaixe
Profile Six point socket / fitting
Perfil sextavado enchufe / encaja



PERFIL SEXTAVADO soquete/encaixe
Profile Six point socket / fitting
Perfil sextavado enchufe / encaja



PERFIL SEXTAVADO com guia
Profile Six point with guide
Perfil sextavado con guía



PERFIL BI-SEXTAVADO soquete/encaixe
Profile twelve point socket / fitting
Perfil bi-sextavado enchufe / encaja



PERFIL SPLINE soquete/encaixe
Profile SPLINE socket / fitting
Perfil SPLINE enchufe / encaja



PERFIL SPLINE bit/ponta
Profile SPLINE point bit/tip
Perfil SPLINE bit/punta



PERFIL SPANNER bit/ponta
Profile SPANNER point bit/tip
Perfil SPANNER bit/punta



PERFIL SPAN bit/ponta
Profile SPAN point bit/tip
Perfil SPAN bit/punta



USO PARA FERRAMENTAS PNEUMÁTICAS
Use for pneumatic tools
Uso para herramientas neumáticas



EMBALAGEM TIPO BLISTER
Blister type packaging
Embalaje tipo blister

BLISTER



ENCAIXE SDS MAX
Socket SDS MAX
Encaje SDS MAX



ENCAIXE SDS PLUS
Socket SDS PLUS
Encaje SDS PLUS



ÁÇO CROMO-VANÁDIO
Steel chromo-vanádio | Acero cromado-vanadio



ÁÇO CROMO-MOLIBDÊNIO
Chrome-molybden steel | Acero cromado-molibdenio



ÁÇO S2
S2steel | Acero S2



ÁÇO FORJADO - DUREZA 45HRc
Forged steel - hardness 45hrc
Acero forjado - dureza 45hrc



ÁÇO CARBONO
Carbon steel
Acero carbono



GRAU DE DUREZA DO AÇO
Strength of steel hardness
Grado de dureza del acero



IMÃ MINEDIN
Magnet minedin
Imán minedin



PARA TRABALHOS EM ÁREAS COM VOLTAGEM DE ATÉ 1000V
For work in areas with voltage up to 1000V
Para trabajos en áreas con voltagen de hasta 1000V



PADRÃO INTERNACIONAL DE SEGURANÇA PARA PRODUTOS ELETRO-ELETRÔNICOS

International standard of safety for electronic-electronic products

Estándar internacional de seguridad para productos electrón-electrónicoS



NORMA INTERNACIONAL IEC 60900:2004 PARA PRODUTOS ELETRO-ELETRÔNICOS

International standard iec 60900: 2004 For electronic-electronic products

Norma internacional iec 60900: 2004 Para productos electrón-electrónicoS



NORMA INSTITUTO ALEMÃO PARA NORMALIZAÇÃO

O uso da norma DIN, bem como de outras normas internacionais, assegura um padrão de qualidade na fabricação de produtos e equipamentos, refletindo diretamente na segurança do consumidor final.

GERMAN INSTITUTE FOR NORMALIZATION The use of the DIN standard, as well as other international standards, ensures a quality standard in the manufacture of products and equipment, directly reflecting the safety of the final consumer.

INSTITUTO ALEMÁN PARA NORMALIZACIÓN El uso de la norma DIN, así como de otras normas internacionales, asegura un estándar de calidad en la fabricación de productos y equipos, reflejando directamente en la seguridad del consumidor final.



44 **3425-5302 / 99882-9804** 

Rua Projetada A, s/n - Loanda - Paraná

www.bruen.com.br

comercial@bruen.com.br